

CLEANING SOLUTIONS

PRICE LIST 2021

TOOLS



IPC



IPC

A leading player
in the professional cleaning market.

#01



**#1 ITALIAN
MANUFACTURER**

IPC is Italy's #1 manufacturer of equipment for professional cleaning, ranking third in the professional cleaning market in Europe.

#02



**WIDE
PORTFOLIO**

IPC provides a complete range of professional equipment including mops and frames, professional trolleys, window cleaning equipment.

#03



**GLOBAL
DISTRIBUTION**

Distributed in over 120 countries. Nine owned international subsidiaries, focused on sales and aftersales.

#04



**ENVIRONMENTALLY
FRIENDLY**

The group, focused on sustainable technologies, has developed a product line which uses recycled plastic thus preserving the environment and its unique and precious resources.

IPC IS ALWAYS WITH YOU ON PC, TABLET & SMARTPHONE

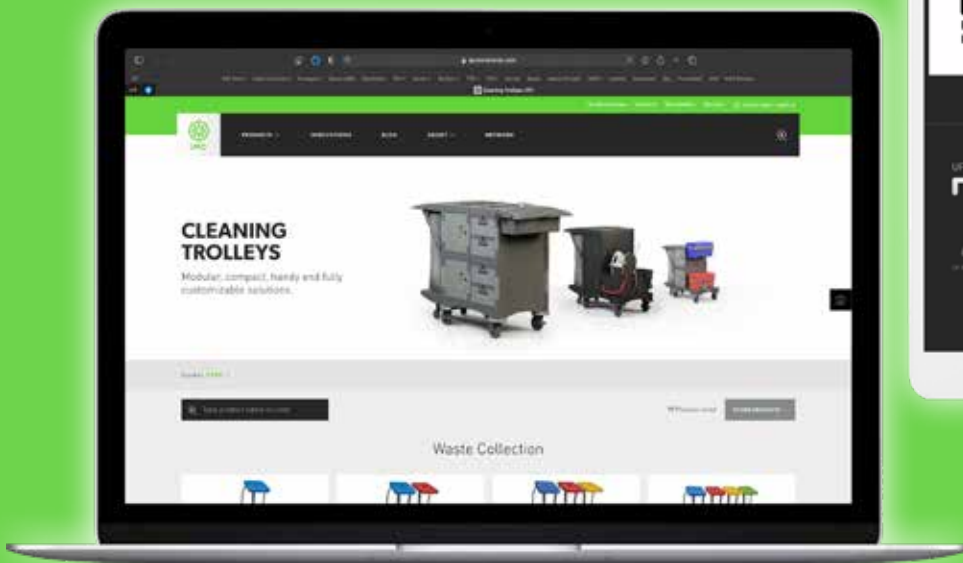

**DOWNLOAD OUR
IPC CATALOGUES APP**
**DISCOVER OUR OFFICIAL WEBSITE
IPCWORLDWIDE.COM**



VISIT OUR OFFICIAL WEBSITE IPCWORLDWIDE.COM

Easy access to product leaflets, pics and videos from any device.



DOWNLOAD OUR IPC CATALOGUES APP

Once downloaded, catalogues are always available, even offline.



REGISTER TO IPC BUSINESS AREA

You will have access to all IPC technical and commercial docs.



SIGN UP ON WEBSITE TO RECEIVE OUR NEWSLETTER

Keep updated on our latest news including new IPC products and events.

FOLLOW US



www.linkedin.com/company/ipcworldwide/
www.youtube.com/c/IPCWorldwide/
www.instagram.com/ipcworldwide/
www.ipcworldwide.com/it/blog/

KEEP IN TOUCH WITH US

info@ipcworldwide.com





ONE AHEAD

ADDRESSING NEW CLEANING CHALLENGES

Cleaning is consistently evolving, as we seek to meet higher hygiene standards ever more effectively.

IPC is closely connected to the latest and best practises of cleaning and is committed to deliver new solutions that boost cleaning efficiency, addressing those areas and tasks that are evolving fastest.

We have thus developed a complete range of new solutions, responding to the latest precautionary practises focused to protect communities all around the world.



STEP LEAD



pag 11

**MOPS
&
FRAMES
RANGE**

pag 76

**CLOTHS &
SPONGES**

pag 82

**WASTE
COLLECTION**

pag 93

TROLLEYS

pag 213

CLEANO SERIES

pag 226

WINDOW CLEANING

pag 242

DISPENSERS

pag 253

DRYERS

APPLICATION AREAS



OFFICE
HORECA
HOSPITALITY



MANUFACTURING
INDUSTRY



WAREHOUSE
LOGISTIC



RETAILS



PUBLIC
GOVERNMENT



HEALTHCARE



EDUCATION



TRANSPORT HUB

TECHNICAL SPECIFICATIONS



WASHING
TEMPERATURE



WASHING
CYCLES



TUMBLE DRY
NORMAL



BLEACH
RESISTANT



YIELD
PER m²

MOPS & FRAMES RANGE

IPC frames combine ergonomics, productivity and efficiency. Specific frames for all needs: hook and loop fasteners, flap or pocket types. Made to reach even the most difficult points.

- RESISTANT
- LIGHTWEIGHT
- ERGONOMIC
- EASY TO USE
- 100% RECYCLABLE

THE MOST COMPLETE RANGE OF FRAMES IN THE MARKET.

MOPS & FRAMES RANGE

COMPATIBILITY TAB A



STANDARD DUST MOP **SUPER EXPORT DUST MOP** **ACRYLIC DUST MOP**

CODE	DIMENSION	PAGE	18	18	18
------	-----------	------	----	----	----



FOLDING PLASTIC SWEEPER FRAME 21

ATPA00016 / ATPA02016	40 cm	FRAN00008	FRAN00035	FRAN01799-0005
ATPA00017 / ATPA02017	60 cm	FRAN00009	FRAN00036	FRAN01800-0005
ATPA00018 / ATPA02018	80 cm	FRAN00012	FRAN00037	FRAN01801-0005
ATPA00019 / ATPA02019	100 cm	FRAN00014	FRAN00038	FRAN01802-0005



FOLDING METAL SWEEPER FRAME 21

ATPA00008 / ATPA02008	40 cm	FRAN00008	FRAN00035	FRAN01799-0005
ATPA00009 / ATPA02009	60 cm	FRAN00009	FRAN00036	FRAN01800-0005
ATPA00010 / ATPA02010	80 cm	FRAN00012	FRAN00037	FRAN01801-0005
ATPA00011 / ATPA02011	100 cm	FRAN00014	FRAN00038	FRAN01802-0005



FIXED METAL SWEEPER FRAME 21

ATPA00005	110 cm	FRAN00652	FRAN00337	FRAN00322
ATPA00006	130 cm	FRAN00673	FRAN00339	FRAN00324
ATPA00007	160 cm	FRAN00686	FRAN00340	FRAN00325



MOP & FRAME RANGE COMPATIBILITY TAB B



RE-MOP SUPACLE DUAL PERFORMANCE SHARK CORAL DEEP SNOW ONLY SCRUB

CODE	DIMENSION	PAGE	34	34	35	35	35	36	37
RAIL / SLIDE		31							
ATPA00034 / ATPA02034	40 cm		FRAN01659	FRAN01634	FRAN01639	FRAN01644	FRAN01642	FRAN01487	FRAN01521
ATPA00037 / ATPA02037	60 cm							FRAN01488	FRAN01522
ATPA00038 / ATPA02038	80 cm							FRAN01489	FRAN01523
ATPA00033 / ATPA02033	100 cm							FRAN01490	FRAN01524
ALUVEL		32							
ATPA00125	40 cm		FRAN01659	FRAN01634	FRAN01639	FRAN01644	FRAN01642	FRAN01487	FRAN01521
DUPLEX		32							
ATPA00080	40 cm		FRAN01659	FRAN01634	FRAN01639	FRAN01644	FRAN01642	FRAN01487	FRAN01521
ATPA00084	40 cm		FRAN01659	FRAN01634	FRAN01639	FRAN01644	FRAN01642	FRAN01487	FRAN01521
OLYMPIC / ONE		33							
ATPA00066	40 cm							FRAN01478	FRAN01512
								FRAN01481	FRAN01515
								FRAN01484	FRAN01518
OLYMPIC / ONE PREMIUM		33							
ATPA00146	40 cm							FRAN01478	FRAN01512
								FRAN01481	FRAN01515
								FRAN01484	FRAN01518
SPEEDCLEAN / BOOK		34							
ATPA00012	40 cm							FRAN01478	FRAN01512
								FRAN01481	FRAN01515
								FRAN01484	FRAN01518
ATPA00014	50 cm							FRAN01480	FRAN01514
								FRAN01483	FRAN01517
								FRAN01486	FRAN01520
ECOMIX		34							
ATPA02059	42 cm							FRAN01474	FRAN1508
SANI SIMPLE		34							
ATPA00069 / ATPA02069	40 cm							FRAN01474	FRAN01508
ATPA00055 / ATPA02055	50 cm							FRAN01475	FRAN01509
AUTOMATIK / NO TOUCH		34							
ATPA00064 / ATPA02064	40 cm							FRAN01477	FRAN01511
ATPA00063 / ATPA02063	42 cm							FRAN01476	FRAN01510
SAFE T		35							
ATPA00214	40 cm							FRAN01474	FRAN1508
TRIGGY		61							
ATPA00111	40 cm		FRAN01659	FRAN01634	FRAN01639	FRAN01644	FRAN01642	FRAN01487	FRAN01521
TRIGGY DETACHABLE		61							
ATPA00147	40 cm		FRAN01659	FRAN01634	FRAN01639	FRAN01644	FRAN01642	FRAN01487	FRAN01521



MOP & FRAME RANGE COMPATIBILITY TAB B



			SNOW	HYGIENE	SPOT	PREMIUM HYGIENE	LOOP ECOLABEL	LOOP	PATH	COPO	RING
CODE	DIMENSION	PAGE	38	39	40	41		42	43	44	44
RAIL / SLIDE		31									
ATPA00034 / ATPA02034	40 cm		FRAN00974	FRAN00981	FRAN00982	FRAN00983	FRAN0200X	FRAN01092	FRAN01089	FRAN00472	
ATPA00037 / ATPA02037	60 cm		FRAN01035	FRAN01046	FRAN00866	FRAN01061	FRAN0202X	FRAN01094	FRAN01091	FRAN00474	
ATPA00038 / ATPA02038	80 cm		FRAN01262	FRAN01268	FRAN01274	FRAN01280	FRAN0203X	FRAN01286	FRAN01292	FRAN00476	
ATPA00033 / ATPA02033	100 cm		FRAN01263	FRAN01269	FRAN01275	FRAN01281	FRAN0204X	FRAN01287	FRAN01293	FRAN00471	
ALUVEL		32									
ATPA00125	40 cm		FRAN00974	FRAN00981	FRAN00982	FRAN00983	FRAN0200X	FRAN01092	FRAN01089	FRAN00472	
DUPLEX		32									
ATPA00080	40 cm		FRAN00974	FRAN00981	FRAN00982	FRAN00983	FRAN0200X	FRAN01092	FRAN01089	FRAN00472	
ATPA00084	40 cm		FRAN00974	FRAN00981	FRAN00982	FRAN00983	FRAN0200X	FRAN01092	FRAN01089	FRAN00472	
OLYMPIC / ONE		33									
ATPA00066	40 cm		FRAN01202 FRAN01205 FRAN01208	FRAN01211 FRAN01217	FRAN01220 FRAN01223 FRAN01226	FRAN01229 FRAN01235	FRAN0200X	FRAN01238 FRAN01241	FRAN01249 FRAN01252	FRAN01304 FRAN01307	FRAN01313 FRAN01316
OLYMPIC / ONE PREMIUM		33									
ATPA00146	40 cm		FRAN01202 FRAN01205 FRAN01208	FRAN01211 FRAN01217	FRAN01220 FRAN01223 FRAN01226	FRAN01229 FRAN01235	FRAN0200X	FRAN01238 FRAN01241	FRAN01249 FRAN01252	FRAN01304 FRAN01307	FRAN01313 FRAN01316
SPEEDCLEAN / BOOK		34									
ATPA00012	40 cm		FRAN01202 FRAN01205 FRAN01208	FRAN01211 FRAN01217	FRAN01220 FRAN01223 FRAN01226	FRAN01229 FRAN01235		FRAN01238 FRAN01241	FRAN01249 FRAN01252	FRAN01304 FRAN01307	FRAN01313 FRAN01316
ATPA00014	50 cm		FRAN01204 FRAN01207 FRAN01210	FRAN01213 FRAN01219	FRAN01222 FRAN01225 FRAN01228	FRAN01231 FRAN01237		FRAN01240 FRAN01248	FRAN01251 FRAN01254	FRAN01306 FRAN01309	FRAN01315 FRAN01318
ECOMIX		34									
ATPA00069	42 cm		FRAN01258	FRAN01264	FRAN01270	FRAN01276		FRAN01282		FRAN00469	FRAN00134
SANI SIMPLE		34									
ATPA00069 / ATPA02069	40 cm		FRAN01258	FRAN01264	FRAN01270	FRAN01276		FRAN01282	FRAN01288	FRAN01301	FRAN00134
ATPA00055 / ATPA02055	50 cm		FRAN01259	FRAN01265	FRAN01271	FRAN01277		FRAN01283	FRAN01289	FRAN00469	FRAN00401
AUTOMATIK / NO TOUCH		34									
ATPA00064 / ATPA02064	40 cm		FRAN01362	FRAN01364	FRAN01366	FRAN01368		FRAN01370	FRAN01372	FRAN01374	
ATPA00063 / ATPA02063	42 cm		FRAN01361	FRAN01363	FRAN01365	FRAN01367		FRAN01369	FRAN01371	FRAN01373	
SAFE T		35									
ATPA00214	40 cm		FRAN01258	FRAN01264	FRAN01270	FRAN01276		FRAN01282		FRAN00469	FRAN00134
TRIGGY		61									
ATPA00111	40 cm		FRAN00974	FRAN00981	FRAN00982	FRAN00983		FRAN01092	FRAN01089	FRAN00472	
TRIGGY DETACHABLE		61									
ATPA00147	40 cm		FRAN00974	FRAN00981	FRAN00982	FRAN00983		FRAN01092	FRAN01089	FRAN00472	



MOP & FRAME RANGE COMPATIBILITY TAB B



GREY



TUFTING EXPORT



COMBIMOP



TUFTING LIGHT



TRIOMOP ZEBRY



TRIOMOP HYGIENE



CODE	DIMENSION	PAGE	45	45	46	46	49	49
RAIL / SLIDE		31						
ATPA00034 / ATPA02034	40 cm		FRAN00519				FRAN01409	FRAN01156
ATPA00037 / ATPA02037	60 cm		FRAN00522					
ATPA00038 / ATPA02038	80 cm		FRAN00524					
ATPA00033 / ATPA02033	100 cm		FRAN00518					



ALUVEL		32						
ATPA000125	40 cm		FRAN00519				FRAN01409	FRAN01156



DUPLEX		32						
ATPA00080	40 cm		FRAN00519				FRAN01409	FRAN01156
ATPA00084	40 cm		FRAN00519				FRAN01409	FRAN01156



OLYMPIC / ONE		33						
ATPA00066	40 cm		FRAN01322 FRAN01325 FRAN01328	FRAN01332 FRAN01335	FRAN01338 FRAN01341	FRAN01344 FRAN01347	FRAN00902	FRAN01123



OLYMPIC / ONE PREMIUM		33						
ATPA00146	40 cm		FRAN01322 FRAN01325 FRAN01328	FRAN01332 FRAN01335	FRAN01338 FRAN01341	FRAN01344 FRAN01347	FRAN00902	FRAN01123



SPEEDCLEAN / BOOK		34						
ATPA00012	40 cm		FRAN01322 FRAN01325 FRAN01328	FRAN01332 FRAN01335	FRAN01338 FRAN01341	FRAN01344 FRAN01347		
ATPA00014	50 cm		FRAN01324 FRAN01327	FRAN01334 FRAN01337	FRAN01340 FRAN01343	FRAN01346 FRAN01349		



ECOMIX		34						
ATPA02059	42 cm		FRAN00515	FRAN00753	FRAN00465	FRAN00348	FRAN00902	FRAN01123



SANI SIMPLE		34						
ATPA00069 / ATPA02069	40 cm		FRAN00515	FRAN00753	FRAN00465	FRAN00348	FRAN00902	FRAN01123
ATPA00055 / ATPA02055	50 cm		FRAN01319	FRAN01331	FRAN00467	FRAN00352	FRAN01297	FRAN01124



AUTOMATIK / NO TOUCH		34						
ATPA00064 / ATPA02064	40 cm		FRAN01374					
ATPA00063 / ATPA02063	42 cm		FRAN01373					



SAFE T		35						
ATPA00214	40 cm		FRAN00515	FRAN00753	FRAN00465	FRAN00348	FRAN00902	FRAN01123



TRIGGY		61						
ATPA00111	40 cm		FRAN00519				FRAN01409	FRAN01156

TRIGGY DETACHABLE		61						
ATPA00147	40 cm		FRAN00519				FRAN01409	FRAN01156



**SWEEPERS
&
HANDLES
RANGE**
COMPATIBILITY
TAB C

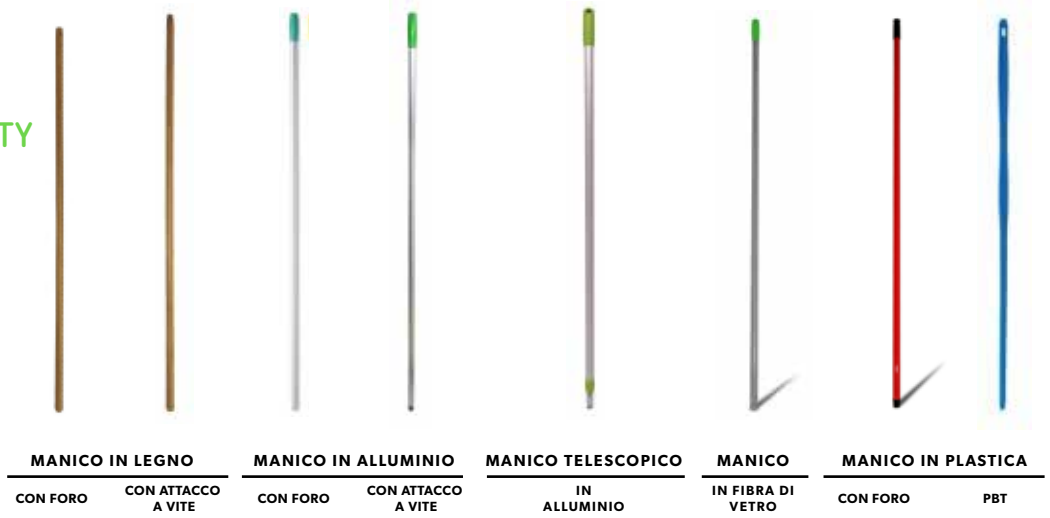

MANICO IN LEGNO		MANICO IN ALLUMINIO		MANICO TELESCOPICO	MANICO	MANICO IN PLASTICA	
CON FORO	CON ATTACCO A VITE	CON FORO	CON ATTACCO A VITE	IN ALLUMINIO	IN FIBRA DI VETRO	CON FORO	PBT

CODE	DIM	PAGE	56	56	56	56	56	56	56	20
------	-----	------	----	----	----	----	----	----	----	----

PVC INDUSTRIAL SWEEPER WITH WOODEN SUPPORT



24

SCOP00127	60 cm	MANI00006 MANI00007	MANI00008 MANI00009
SCOP00042	80 cm	MANI00006 MANI00007	MANI00008 MANI00009

COCONUT INDUSTRIAL SWEEPER



24

SCOP00045	60 cm	MANI00006 MANI00007	MANI00008 MANI00009
SCOP00046	80 cm	MANI00006 MANI00007	MANI00008 MANI00009

PVC INDUSTRIAL SWEEPER WITH PLASTIC SUPPORT



24

SCOP00040	45 cm	MANI00008 MANI00009	MANI00030 ●●●●	MANI00005 ●0002	MANI00054 ●●●●
SCOP00041	60 cm	MANI00008 MANI00009	MANI00030 ●●●●	MANI00005 ●0002	MANI00054 ●●●●

PBT BROOM FOR FOOD AREAS



24

SCOP00044	35 cm	MANI00006 MANI00007	MANI00008 MANI00009	MANI00029 ●●●●	MANI00030 ●●●●	MANI00032 MANI00033 ●●●●	MANI00035 ●0009	MANI00005 ●0002	MANI00054 ●●●●
SCOP00129 - 0005	45 cm	MANI00006 MANI00007	MANI00008 MANI00009	MANI00029 ●●●●	MANI00030 ●●●●	MANI00032 MANI00033 ●●●●	MANI00035 ●0009	MANI00005 ●0002	MANI00054 ●●●●



**FLOOR SQUEEGES
& HANDLES
RANGE**
COMPATIBILITY
TAB D



WOODEN HANDLE		ALUMINUM HANDLE		TELESCOPIC HANDLE	HANDLE	PAINTED HANDLE	
WITH HOLE	WITH ITALIAN THREAD	WITH HOLE	WITH ITALIAN THREAD	ALUMINUM	GLASS FIBER	WITH HOLE	PBT

CODE	DIGIT	PAGE	56	56	56	56	56	56	56	20
------	-------	------	----	----	----	----	----	----	----	----

**POLYPROPYLENE FLOOR SQUEEGEE
BLACK IS GREEN™**



ATPA00023										
ATPA00024	9999	64	MANI00006 MANI00007	MANI00008 MANI00009	MANI00029 ●●●●●	MANI00030 ●●●●●	MANI00032 MANI00033 ●●●●●	MANI00035 ●0009	MANI00005 ●0002	MANI00054 ●●●●●
ATPA00025										

SPINGIACQUA IN POLIPROPILENE



ATPA00026										
ATPA00023	● 1515	64	MANI00006 MANI00007	MANI00008 MANI00009	MANI00029 ●●●●●	MANI00030 ●●●●●	MANI00032 MANI00033 ●●●●●	MANI00035 ●0009	MANI00005 ●0002	MANI00054 ●●●●●
ATPA00024										
ATPA00025										

METAL FLOOR SQUEEGEE



ATPA00020										
ATPA00021		64	MANI00006 MANI00007	MANI00008 MANI00009	MANI00029 ●●●●●	MANI00030 ●●●●●		MANI00035 ●0009	MANI00005 ●0002	
ATPA00022										

NYLON FLOOR SQUEEGEE (WITH BLACK RUBBER))

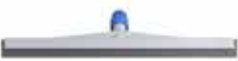

ATPA00101										
ATPA00098	● 1506	64	MANI00006 MANI00007	MANI00008 MANI00009	MANI00029 ●●●●●	MANI00030 ●●●●●	MANI00032 MANI00033 ●●●●●	MANI00035 ●0009	MANI00005 ●0002	MANI00054 ●●●●●
ATPA00099	● 0206									
ATPA000100										

NYLON FLOOR SQUEEGEE (WITH WHITE RUBBER)



ATPA00043										
ATPA00044	○ 0101	64	MANI00006 MANI00007	MANI00008 MANI00009	MANI00029 ●●●●●	MANI00030 ●●●●●	MANI00032 MANI00033 ●●●●●	MANI00035 ●0009	MANI00005 ●0002	MANI00054 ●●●●●
ATPA00045										

NYLON FLOOR SQUEEGEE (WITH RED RUBBER)



ATPA00039										
ATPA00040	● 0206	64	MANI00006 MANI00007	MANI00008 MANI00009	MANI00029 ●●●●●	MANI00030 ●●●●●	MANI00032 MANI00033 ●●●●●	MANI00035 ●0009	MANI00005 ●0002	MANI00054 ●●●●●
ATPA00041										

DRY CLEANING

MINIMIZING THE SPREAD OF DUST IN THE AIR.

The activity can be distinguished between:
DRY or **WET SWEEPING**

01

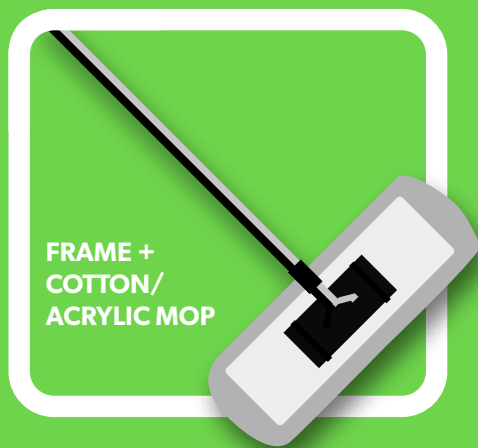

FOR DRY SWEEPING

cotton or acrylic dust mops replacements of various sizes are used with suitable articulated frames.

02

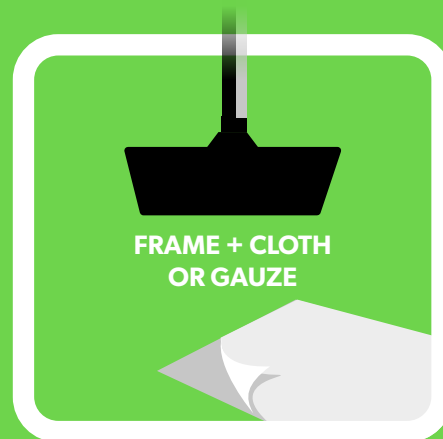

FOR WET SWEEPING

a frame, usually trapezoidal, is used with disposables impregnated [by mineral oils] cloth or with a cotton gauze.

THE RECOMMENDED TECHNIQUE

is to move back toward the entrance with "S" movements

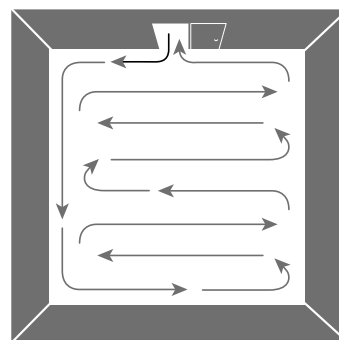

It is recommended to use one gauze at a time, replacing it if necessary (depending on the amount of dirt, no more than 40/60 m²) and without lifting the tool during the sweeping operation.

STANDARD DUST MOPS

COMPLETE



CODE	CM	UNITS BOX	TYPE	UNIT PRICE
SCOP00001	40	20	STANDARD COTTON	€ 17,30
SCOP00002	60	15	STANDARD COTTON	€ 20,30
SCOP00003	80	15	STANDARD COTTON	€ 21,75
SCOP00004	100	15	STANDARD COTTON	€ 26,40

The replacements are provided with pockets.

"V" SWEEPERS

COMPLETE



CODE	CM	UNITS BOX	TYPE	HANDLE	UNIT PRICE
SCOP00058	105	6	STANDARD COTTON	STRENGTHENED	€ 77,50
SCOP00059	105	6	EXPORT COTTON	STRENGTHENED	€ 81,30
SCOP00062	105	6	RAYON	STRENGTHENED	€ 87,30
SCOP00061	105	6	ACRYLIC	STRENGTHENED	€ 84,00

The replacements are provided with buttons.

COMPONENTS:

CHROMED HANDLE FOR "V" SWEEPER

CODE
MANI00004

● 0009

UNITS/BOX
10

TYPE
STANDARD

UNIT PRICE
€ 26,40



FEET REPLACEMENT WITH METAL PAWLS

CODE
PMLA95924

CM
105

UNITS/BOX
10

UNIT PRICE
€ 26,40



METAL PAWLS FOR "V" SWEEPER

CODE
PMLA00257

UNITS/BOX
10

UNIT PRICE
€ 8,45



FOLDING PLASTIC
SWEEPER FRAME



CODE	DIGIT	CM	UNITS BOX	UNIT PRICE
ATPA02016	IP09	40	40	€ 3,95
ATPA02017	IP09	60	25	€ 4,65
ATPA02018	IP09	80	25	€ 5,30
ATPA02019	IP09	100	25	€ 6,80



CODE	DIGIT	CM	UNITS BOX	UNIT PRICE
ATPA00016	IP09	40	40	€ 3,95
ATPA00017	IP09	60	25	€ 4,65
ATPA00018	IP09	80	25	€ 5,30
ATPA00019	IP09	100	25	€ 6,80

FOLDING METAL
SWEEPER FRAME



CODE	CM	UNITS BOX	UNIT PRICE
ATPA02008	40	40	€ 8,65
ATPA02009	60	25	€ 9,55
ATPA02010	80	25	€ 10,60
ATPA02011	100	25	€ 12,00



CODE	CM	UNITS BOX	UNIT PRICE
ATPA00008	40	40	€ 8,65
ATPA00009	60	25	€ 9,55
ATPA00010	80	25	€ 10,60
ATPA00011	100	25	€ 12,00

FIXED METAL
SWEEPER FRAME



CODE	CM	UNITS BOX	UNIT PRICE
ATPA00005	110	10	€ 28,95
ATPA00006	130	10	€ 31,50
ATPA00007	160	10	€ 34,00

COMPONENTI:

CLIP

CODE
MPVR94540 - 0027

UNIT PRICE
€ 0,41



CODE
MPVR94540 - 0009

PREZZO
UNITARIO
€ 0,41



PLASTIC SCREW

CODE
MPVR94541 - 0009

PACK
10

UNIT PRICE
€ 0,92



2 PCS. CHROMED HANDLE WITH HOLE

CODE
MANI00001
● 0009

DIMENSION
Ø22 x 130 cm

PACK
50

UNIT PRICE
€ 7,65

CODE
MANI00002
● 0009

DIMENSION
Ø22 x 145 cm

PACK
50

UNIT PRICE
€ 8,45



COMPONENTS:

COLOURED GRIP

CODE
MAN000003

● 0015 ● 0002
● 0009 ● 0004

UNIT PRICE
€ 0,82



* For all handles except for Aluminum Telescopic Handle and Ergonomic Telescopic Handle

CLOSING SYSTEM

CODE
KTRI06969

UNIT PRICE
€ 0,72



STANDARD DUST MOP

REPLACEMENT



SPECIFICATIONS

- Central baking: cotton
- Pockets: cotton
- Lateral ribbon: cotton
- Yarn: cotton, mixed fibres
- Laces: polyester

CODE	CM	UNITS BOX	TYPE	UNIT PRICE
FRAN00008	40	40	POCKETS	€ 5,30
FRAN00009	60	30	POCKETS	€ 7,00
FRAN00012	80	30	POCKETS	€ 9,15
FRAN00014	100	30	POCKETS	€ 12,20
FRAN00652	110	20	LACES	€ 15,85
FRAN00673	130	20	LACES	€ 19,40
FRAN00686	160	20	LACES	€ 24,70

All sizes are available also with laces or snaps.

SUPER EXPORT DUST MOP

REPLACEMENT



SPECIFICATIONS

- Central baking: polyester
- Pockets: polyester
- Lateral ribbon: polyester
- Yarn: cotton, polyester
- Laces: polyester

CODE	CM	UNITS BOX	TYPE	UNIT PRICE
FRAN00035	40	40	POCKETS	€ 8,15
FRAN00036	60	30	POCKETS	€ 9,15
FRAN00037	80	30	POCKETS	€ 11,20
FRAN00038	100	30	POCKETS	€ 13,60
FRAN00337	110	20	LACES	€ 21,55
FRAN00339	130	20	LACES	€ 24,60
FRAN00340	160	20	LACES	€ 27,40

All sizes are available also with laces.

ACRYLIC DUST MOP

REPLACEMENT



SPECIFICATIONS

- Central baking: cotton
- Pockets: cotton
- Lateral ribbon: cotton
- Yarn: acrylic
- Laces: polyester

CODE	CM	UNITS BOX	TYPE	UNIT PRICE
FRAN01799-0005	40	40	POCKETS	€ 6,50
FRAN01800-0005	60	30	POCKETS	€ 8,45
FRAN01801-0005	80	30	POCKETS	€ 11,60
FRAN01802-0005	100	30	POCKETS	€ 15,25
FRAN00322	110	20	LACES	€ 19,10
FRAN00324	130	20	LACES	€ 22,45
FRAN00325	160	20	LACES	€ 27,40

All sizes are available also with laces or snaps.

100% COTTON GAUZE

CODE
TESS00012

DIMENSION
80x100 cm

UNITS/BOX
100

UNIT PRICE
€ 3,15



STANDARD DUST MOP

REPLACEMENT FOR "V" SWEEPER



SPECIFICATIONS

- Central baking: cotton
- Laces: polyester
- Lateral ribbon: cotton
- Yarn: cotton, mixed fibres

CODE	CM	UNITS BOX	TYPE	* UNIT PRICE
FRAN00042	105	12	BUTTONS	€ 22,95
FRAN00342	105	12	LACES	€ 24,20

SUPER EXPORT DUST MOP

REPLACEMENT FOR "V" SWEEPER



SPECIFICATIONS

- Central baking: polyester
- Laces: polyester
- Lateral ribbon: polyester
- Yarn: cotton, polyester

CODE	CM	UNITS BOX	TYPE	* UNIT PRICE
FRAN01408	105	12	BUTTONS	€ 31,10
FRAN00046	105	12	LACES	€ 32,10

ACRYLIC DUST MOP

REPLACEMENT FOR "V" SWEEPER



SPECIFICATIONS

- Central baking: cotton
- Laces: polyester
- Lateral ribbon: cotton
- Yarn: acrylic

CODE	CM	UNITS BOX	TYPE	* UNIT PRICE
FRAN00044	105	12	BUTTONS	€ 27,60
FRAN00344	105	12	LACES	€ 28,75

* THE PRICE REFERS TO A COUPLE

PVC INDUSTRIAL SWEEPER

WITH WOODEN SUPPORT

CODE SCOP00127	CODE SCOP00042
DIMENSION 60 cm	DIMENSION 80 cm
UNITS/BOX 10	UNITS/BOX 10
UNIT PRICE € 14,45	UNIT PRICE € 20,30



COCONUT INDUSTRIAL SWEEPER

CODE SCOP00045	CODE SCOP00046
DIMENSION 60 cm	DIMENSION 80 cm
UNITS/BOX 10	UNITS/BOX 10
UNIT PRICE € 18,30	UNIT PRICE € 23,65



PVC INDUSTRIAL SWEEPER

WITH PLASTIC SUPPORT

CODE SCOP00040	CODE SCOP00041
DIMENSION 45 cm	DIMENSION 60 cm
UNITS/BOX 6	UNITS/BOX 6
UNIT PRICE € 10,80	UNIT PRICE € 14,45



For the combinations with the handles see TAB C - page 13

PBT BROOM FOR FOOD AREAS

WITH THREADED HANDLE CONNECTOR

CODE SCOP00044	CODE SCOP00129 - 0005
DIMENSION 35 cm	DIMENSION 45 cm
UNITS/BOX 5	UNITS/BOX 6
UNIT PRICE € 16,45	UNIT PRICE € 34,50



For the combinations with the handles see TAB C - page 13

PLASTIC HANDLE FOR PBT BROOM

CODE
MANI00054

DIGIT
 ● 0005
 ● 0003
 ● 0004
 ● 0002

DIMENSION
Ø 2,50 x 145 cm

UNITS/BOX
10

UNIT PRICE
€ 15,55



PLASTIC SWEEPER

CODE
SCOP00063

DIMENSION
55 cm

UNITS/BOX
24

UNIT PRICE
€ 13,10



WOODEN HANDLE FOR PLASTIC SWEEPER

CODE
MANI00010

DIMENSION
Ø 2,50 x 150 cm

UNITS/BOX
24

UNIT PRICE
€ 4,70





SIMPLY/FASTY

CODE
PATT00008 - 0006

DIMENSION
 71 cm

UNITS/BOX
 10

UNIT PRICE
€ 16,40



SIMPLY/FASTY LH

CODE
PATT00015 - 0006

DIMENSION
 87 cm

UNITS/BOX
 10

UNIT PRICE
€ 16,55

COMPOSITION	CODE	UNITS/BOX	UNIT PRICE
Broom	SCOP00064	10	€ 4,80
Dustbin 71 cm	PATT00002 - 0006	10	€ 11,10

COMPOSITION	CODE	UNITS/BOX	UNIT PRICE
Broom	SCOP00064	10	€ 4,80
Dustbin 87 cm	PATT00004 - 0006	10	€ 11,80

SIMPLY/FASTY EVOLUTION
 COMPLETE KIT

CODE
PATT00010

UNITS/BOX
 10

UNIT PRICE
€ 26,90





LAMIRAIL / EVOSLIDE

WITH RUBBER

CODE
ATPA02096 - IP09

DIMENSION
55 cm

UNITS/BOX
10

UNIT PRICE
€ 35,30

CODE
ATPA02097 - IP09

DIMENSION
90 cm

UNITS/BOX
1

UNIT PRICE
€ 57,15

DETAILS

- **HIGH PERFORMANCES**
- **ECONOMIC**: it can be used both on horizontal and vertical surfaces
- **ERGONOMIC**: light aluminum structure
- **INNOVATIVE**: the new sliding system and its "lock & unlock" mechanism ensures a perfect cleaning also on areas with difficult access

TIPO DI RICAMBIO:
USA E GETTA

SISTEMA DI PULIZIA:
SPOLVERATURA



PIC. 1
Lock & unlock the system to position the joint



PIC. 2
Moving the joint to the right or left according to need



PIC. 3
Thanks to the reduced thickness (25 mm) it is possible to clean under low-rise furniture



LAMIRAIL / EVOSLIDE
WITH RUBBER

CODE
ATPA00096 - 0009

DIMENSION
55 cm

UNITS/BOX
10

UNIT PRICE
€ 35,30

CODE
ATPA00097 - 0009

DIMENSION
90 cm

UNITS/BOX
1

UNIT PRICE
€ 57,15

LAMIWELL / EVOWELL
WITH RUBBER



CODE	CM	UNITS BOX	UNIT PRICE
ATPA02073 - IP09	55	10	€ 30,80



CODE	CM	UNITS BOX	UNIT PRICE
ATPA02092 - IP09	90	1	€ 53,30

CLOTH HOLDER
WITH FOAM



CODE	CM	UNITS BOX	UNIT PRICE
ATPA02074 - 0009	40	10	€ 17,00
ATPA02215 - 0009	55	10	€ 19,20



CODE	CM	UNITS BOX	UNIT PRICE
ATPA00073 - 1315	55	10	€ 30,80



CODE	CM	UNITS BOX	UNIT PRICE
ATPA00092 - 1315	90	1	€ 53,30



CODE	CM	UNITS BOX	UNIT PRICE
ATPA00074 - 0005	40	10	€ 17,00
MPVR94682 - 0005	55	10	€ 19,20

COMPONENTS:

TABBED CLAMPS

CODE
MPVR94381 - 0013

UNIT PRICE
€ 0,51



RUBBER REPLACEMENTS

CODE CODE
MPVR94380 - 0013 MPVR94382 - 0013

DIMENSION
55 cm

UNIT PRICE
€ 24,20

DIMENSION
90 cm

UNIT PRICE
€ 41,20



COMPONENTS:

TABBED CLAMPS

CODE
MPVR94381 - 0013

UNIT PRICE
€ 0,51



REPLACEMENT FOAM

CODE
SPUG00002

DIMENSION
40 cm

UNIT PRICE
€ 5,00

CODE
SPUG00003

DIMENSION
55 cm

UNIT PRICE
€ 5,60



DISPOSABLES

SUPER STICKY

CODE
PANN00073

DIMENSION
9 m
(perforated
each 15 cm)

UNIT PRICE
€ 13,30



DISPOSABLE WIPES

CODE
PANN00124

● IP02 - ● IP15

DIMENSION
23 m (perforated
each 23 cm)

UNITS/BOX: 1 pc

UNIT PRICE
€ 5,00



PANNO MONOUSO TNT

CODE
PANN00016

DIMENSION
30x40 cm

UNITS/BOX
400 pcs

UNIT PRICE
€ 0,10



60% Viscose
40% Polyester

DISPOSABLE MULTIPURPOSE CLOTH

Use: suitable for cleaning and disinfect surfaces including glass.



CODE	CM	UNITS BOX	UNIT PRICE
PANN00135	30x30	50	€ 5,00

DISPOSABLE CLOTH "STEAM"

Usable with generators of steam.



CODE	CM	UNITS BOX	UNIT PRICE
PANN00137	42x12	20	€ 6,30

DRY WIPE CLOTH

CODICE
PANN00127

PREZZO UNITARIO
€ 5,90 *

ECO WET WIPE CLOTH

IMPREGNATED WITH DETERGENT

CODICE
PANN00130

PREZZO UNITARIO
€ 4,00*

DIMENSION: 13x42 cm
UNITS/BOX: 20 pcs (10 packs)

Use: suitable for cleaning floors and vertical surfaces.



* The price refers to the pack and not the single cloth

DISPOSABLE MICROFIBER

CODE
PANN00129

DIMENSION: 14x42 cm

UNITS/BOX: 50 pcs (12 packs)

UNIT PRICE
€ 9,10 *

* The price refers to the pack and not the single cloth

Use: suitable for dusting, washing and retaining dirt on floor surfaces.



100% pPolyester

IMPREGNATED CLOTHS

VISCOSE IMPREGNATED CLOTH



CODE	CM	UNITS BOX	IMPREGNATION DEGREE	UNIT PRICE
PANN00008	60x22	1000	23 g/m ² (olio minerale)	€ 0,09
PANN00005	60x30	500	15 g/m ² (olio minerale)	€ 0,35

100% viscose

POLYPROPYLENE TEXIS CLOTH



CODE	CM	UNITS BOX	UNIT PRICE
PANN00010	60x22	1000	€ 0,05
PANN00011	60x30	800	€ 0,08

100% polypropylene

POLYPROPYLENE IMPREGNATED CLOTH



CODE	CM	UNITS BOX	IMPREGNATION DEGREE	UNIT PRICE
PANN00003	60x22	1000	7 g/m ² (olio minerale)	€ 0,07
PANN00004	60x30	800	7 g/m ² (olio minerale)	€ 0,10

100% polypropylene

HAVANA IMPREGNATED CLOTH



CODE	CM	UNITS BOX	IMPREGNATION DEGREE	UNIT PRICE
PANN00067	60x22	1000	3,5 g/m ² (olio minerale)	€ 0,04

100% polypropylene

MASSLINN PRE-IMPREGNATED CLOTH



CODE	CM	UNIT BOX	WEIGHT	UNIT PRICE
PANN80004	61x61	500	22 g	€ 1,26

approx. 88% Fibre (Viscose and Polyester) - approx. 12% Binder
With antimicrobial protection

JUST ONCE

CODE
PANN00065

DIMENSION
40 x12 cm

UNITS/BOX
100 pz

UNIT PRICE
€ 0,13



Polyester and viscose disposable cloth, suitable for dusting. The innovative technology ensures a high capacity dust removal in a single step, thus preventing the bacteria's proliferation and the transmission of infections.

APPLICATION AREAS



ONLY ONCE

CODE
PANN00064

DIMENSION
42 x13 cm

UNITS/BOX
50 pz

UNIT PRICE
€ 0,50



Disposable blue cloth with 3 layers (PES/viscose, cellulose pulp and a PP fixing layer) also suitable for washing operations (detergent resistant). Hygienic and economic, ensures effective cleaning operations with the use of chemical detergent, granting maximum productivity and cost saving.

APPLICATION AREAS



FLEX DUSTY/DUSTER CON RICAMBIO MICROFIBRA

CODE
SCOV00003

DIMENSION
72 cm

UNITS/BOX
10

UNIT PRICE
€ 20,80



- FLEXIBLE**



- SUITABLE ALSO TELESCOPIC POLE**

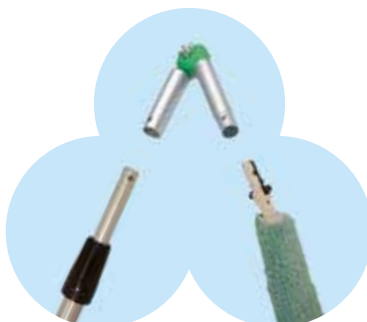
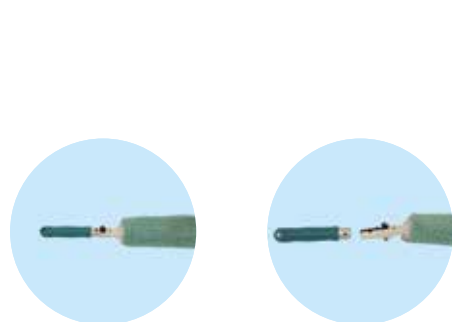

FLEX DUSTY/DUSTER FRAME ONLY

CODE
LAFN20294

DIMENSION
72 cm

UNITS/BOX
10

UNIT PRICE
€ 11,80



MICROFIBRE REPLACEMENT FOR FLEX DUSTY/DUSTER

CODE
SCOV00004

UNITS/BOX
25

UNIT PRICE
€ 9,05



ACRYLIC HAND DUSTER

CODE
SCOV00001

UNITS/BOX
100

UNIT PRICE
€ 5,20



CRANKED JOINT FOR FLEX DUSTY/DUSTER

CODE
RACC00004 - 0003

UNITS/BOX
10

UNIT PRICE
€ 6,80



WASHING & DISINFECTION

FOR SURFACES MANUAL WASHING OPERATIONS

both on floors and walls:

01

PLASTIC FRAME
with flat mop replacement

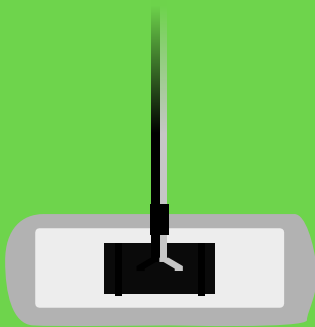

02

ALUMINUM OR PLASTIC FRAME WITH HOOK AND LOOP FASTENERS AND FLAT MOP REPLACEMENT
(with hook and loop fasteners backing)

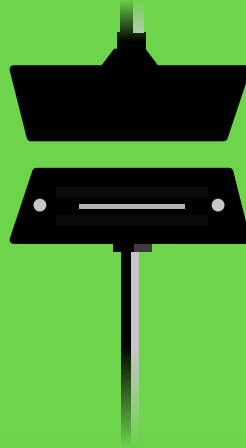

03

MOP HOLDER



THE RECOMMENDED TECHNIQUE

is to move back toward the entrance with "S" movements



DURING WASHING, THE FLAT MOP OR THE KENTUCKY MOP ARE RINSED FREQUENTLY

(the frequency depending on the floor and type of dirt) and wringed out in the wringer.

IN THE CASE OF DISINFECTION or BACTERIAL CONTAMINATION RISK, THE FLAT MOPS TO BE equipped with pockets or hook and loop fasteners backing and must be replaced in every room or after 20/25 m².

WHEN DISINFECTANTS ARE USED, MAKE SURE THAT THE FLOOR REMAINS WET FOR A FEW MINUTES (in any case, follow the instructions on the product label).



RAIL / SLIDE

CODE	CM	UNITS BOX	UNIT PRICE
ATPA02034	40	10	€ 17,40
ATPA02037	60	10	€ 24,20
ATPA02038	80	10	€ 31,30
ATPA02033	100	5	€ 39,50

● 0015 ● 0009

TYPE OF REPLACEMENT:
Mops with hook and loop fasteners and disposables

CLEANING PROCESS:
Washing & Disinfection

DETAILS

- **CLEANS ANYWHERE:** reaches the most unreachable areas thanks to its sliding system "LOCK & UNLOCK"
- **INNOVATIVE:** joint blocking allows also a comfortable cleaning of vertical surfaces
- **ERGONOMIC:** the frame is made of aluminum, extremely light material and therefore particularly easy to handle. Additionally, the sliding joint allows to clean all those points otherwise requiring a physical strain.
- **MAXIMUM HYGIENE AND CLEANLINESS:** mops are removable by foot



RAIL / SLIDE

CODE	CM	UNITS BOX	UNIT PRICE
ATPA00034	40	10	€ 17,40
ATPA00037	60	10	€ 24,20
ATPA00038	80	10	€ 31,30
ATPA00033	100	5	€ 39,50

● 0015 ● 0002 ● 0009 ● 0004

ALUVEL

CODE
ATPA00125



DIMENSION
40 cm

UNITS/BOX
10

UNIT PRICE
€ 13,60

TYPE OF REPLACEMENT:

Mops with hook and loop fasteners

CLEANING PROCESS:

Washing & Disinfection



ACCESSORIES:

ABRASIVE FIBER REPLACEMENT FOR HOLDER WITH HOOK AND LOOP FASTENERS

CODE	CM	UNITS BOX	UNIT PRICE
SPUG00004	40	25	€ 6,00
SPUG00005	60	25	€ 8,15



DISPOSABLES

ADAPTER "LINER" FOR FRAMES WITH VELCRO

NEW

CODE	CM	WEIGHT	UNIT PRICE
PANN00140	42 x 9,7	30 gr	€ 10,00

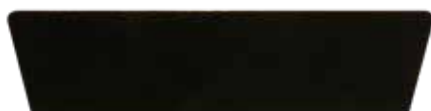

DISPOSABLES

Suitable for all H&L fasteners. Used to flatten the surface of the cloth in contact with the floor, thus increasing the performance of the cloth itself.

COMPATIBLE WITH FRAMES:

Rail / Slide - Aluvel - Duplex - Olympic / One - Triggy - Curvy

DUPLEX

CODE	CM	UNITS BOX	TYPE	UNIT PRICE
ATPA02090 - 0009	30	10	WITHOUT FIXING SYSTEM	€ 11,70
ATPA02089 - 0009	30	10	WITH FIXING SYSTEM	€ 12,50
ATPA02080 - 0009	40	10	WITHOUT FIXING SYSTEM	€ 15,15
ATPA02084 - 0009	40	10	WITH FIXING SYSTEM	€ 16,05

TYPE OF REPLACEMENT:

Mops with hook and loop fasteners

CLEANING PROCESS:

Washing & Disinfection



CODE	CM	UNITS BOX	TYPE	UNIT PRICE
ATPA00090 - 0015	30	10	WITHOUT FIXING SYSTEM	€ 11,70
ATPA00089 - 0015	30	10	WITH FIXING SYSTEM	€ 12,50
ATPA00080 - 0015	40	10	WITHOUT FIXING SYSTEM	€ 15,15
ATPA00084 - 0015	40	10	WITH FIXING SYSTEM	€ 16,05



OLYMPIC/ONE

CODE
ATPA02066

DIMENSION
40 cm

UNITS/BOX
10

UNIT PRICE
€ 16,45

- IP15
- IP09



COMPONENTS:

HOOK AND LOOP FASTENERS REPLACEMENT STRIPES

CODE
KTRI99673

DIMENSION
6,8 cm

UNITS
4

UNIT PRICE
€ 1,12



ACCESSORIES:

FOAM REPLACEMENT

CODE
SPUG00013

DIMENSION
42 cm

UNITS
10

UNIT PRICE
€ 6,00



OLYMPIC/ONE



CODE
ATPA00066

DIMENSION
40 cm

UNITS/BOX
10

UNIT PRICE
€ 16,45

- 0615
- 0602
- IP09
- 0604

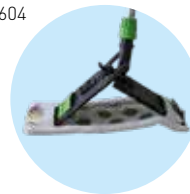

OLYMPIC/ONE PREMIUM
WITHOUT HOOK AND LOOP FASTENERS

CODE
ATPA02146

DIMENSION
40 cm

UNITS/BOX
10

UNIT PRICE
€ 24,00

- IP15
- IP09



OLYMPIC/ONE PREMIUM

CODE
ATPA00146

DIMENSION
40 cm

UNITS/BOX
10

UNIT PRICE
€ 24,00

- 1315
- 1302
- IP09
- 1304



DETAILS

- **HYGENIC:** Dual System opening-closing prevent the operator from touching the dirty mop after use
- **FIVE FRAMES IN ONE:** it can be used with classic flaps, flaps with 2 rings, flaps with 3 rings, pockets & flaps, hook and loop fasteners and disposables
- **INNOVATIVE:** the blocking joint allows also the easy cleaning of vertical surfaces.
- **MULTIFUNCTIONAL:** vertical washing, floor washing, stairs, dusting, ecc.
- **100% RECYCLABLE**
- **RESISTANT:** long lasting materials
- **STRENGTHEN IN THE PREMIUM VERSION** to grant an extra pressure on the mop to obtain uniform cleaning results
- **EXCELLENT RESULTS** in combination with "SPECIAL" FLAPS TYPE MOP

CLEANING PROCESS:
Washing & Disinfection

TYPE OF REPLACEMENT:



The frames with the old color will be available while stocks last.

SPEEDCLEAN / BOOK

CODE
ATPA02012

CODE
ATPA02014

● IP15 ● IP09 ● IP15 ● IP09

DIMENSION
40 cm

DIMENSION
50 cm

UNITS/BOX
10

UNITS/BOX
10

UNIT PRICE
€ 31,80

UNIT PRICE
€ 33,90

TYPE OF REPLACEMENT:

Mops with pockets,
flaps, pockets & flaps

CLEANING PROCESS:

Washing & Disinfection

CODE
ATPA00012

CODICE
ATPA00014

DIMENSION: 40 cm

DIMENSION: 50 cm

UNITS/BOX: 10

UNITS/BOXF: 10

UNIT PRICE: € 31,80

UNIT PRICE: € 33,90

● IP15 ● 0002
● IP09 ● 0004

● IP15 ● 0002
● IP09 ● 0004



DETAILS

• **PRACTICAL AND EFFECTIVE:**
innovative mechanism with stainless
steel springs that allow a fast and
innovative use of the frame on the
floor through a simple pressure

• **HIGH PERFORMANCE
CLEANING**
on all types of surfaces



ECOMIX

CODE	CM	UNITS/BOX	UNIT PRICE
ATPA02059 - 0009	42 x 9	50	6,30€



SANI SIMPLE

CODE	CM	UNITS/BOX	UNIT PRICE
ATPA02069 - 0009	40 x 11	10	€ 24,20
ATPA02055 - 0009	50 x 13	10	€ 26,30

TYPE OF REPLACEMENT: mops with pockets
CLEANING PROCESS: washing & disinfection

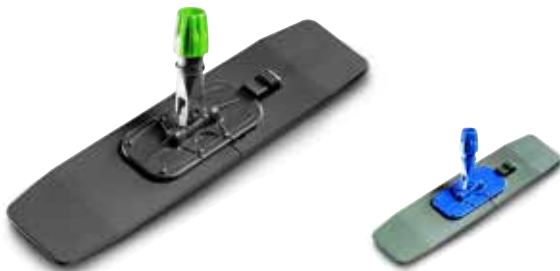

CODE	CM	UNITS/BOX	UNIT PRICE
ATPA00069 - 1506	40 x 11	10	€ 24,20
ATPA00055 - 1506	50 x 13	10	€ 26,30

AUTOMATIK/NO TOUCH

CODE	CM	UNITS/BOX	UNIT PRICE
ATPA02063 - 0009	42 x 9	40	€ 13,10

TYPE OF REPLACEMENT: mops with pockets, mops with flaps.
CLEANING PROCESS: washing & disinfection



CODE	CM	UNITS/BOX	UNIT PRICE
ATPA00063	42 x 9	40	€ 13,10

● 0506 ● 0206 ● 0906 ● 0406

NEW SANI

CODE	CM	UNITS/BOX	UNIT PRICE
ATPA02064 - 0009	40 x 11	20	€ 15,75



TYPE OF REPLACEMENT: mops with pockets, mops with flaps.
CLEANING PROCESS: washing & disinfection

CODE	CM	UNITS/BOX	UNIT PRICE
ATPA00064	40 x 11	20	€ 15,75

● 1506 ● 0206 ● 0906 ● 0406





NEW

SAFE T

The SAFE T frame is the innovative, practical, hygienic and fast cleaning system suitable to the use of spare parts with pockets. Thanks to the new "no-touch" release system, the operator never comes into contact with the used spare part and releases it directly in the waste container by operating the special plastic handle.

SAFE T

CODE	DIGIT	CM	UNITS BOX	UNIT PRICE
ATPA00214	0027	40	10	€ 28,50

The code ATPA00214 is inclusive of only frame. The handle is separate.

ALUMINIUM HANDLE

CODE	SIZE	UNIT PRICE
MANI00079	2,1 x 100 cm	€ 6,20

● 0009 ● 0015

ALUMINIUM TELESCOPIC HANDLE

CODE	SIZE	UNIT PRICE
MANI00033	2 x 70 cm	€ 10,50

● 0009 ● 0015

AVAILABLE FROM: JUNE 2021



PATENT PENDING



FEATURES

- **NO TOUCH:** no contact with the used part
- **HYGIENIC:** no risk of bacterial contamination
- **ERGONOMIC:** the operator does not bend down to position the clean spare nor to collect the used spare while always maintaining a correct posture
- **INSTANT:** thanks to the release system quick "no-touch" replacement of the used part takes very little time.
- **COMPACT:** thanks to the telescopic handle it can also be transported in most means small as well as making it space-saving the packaging.
- **ECOLOGICAL:** all materials with which it is made are recyclable.

The code ATPA00214 is inclusive of only frame. The handle is separate.



WHAT IS MICROFIBER?

Microfibre is a synthetic material composed of two polymers. When joined together in different quantity percentages, these polymers develop into a single thread which is thin and highly resistant.

Polyester electrostatic features allow the microfibre to catch and retain all types of dust.

Polyamide has great absorbing power and, together with water use, eases dirt removal and the degreasing of surfaces without leaving any marks or stains.

Microfiber specific uniqueness is its **EXTREMELY THIN STRUCTURE** and **HIGH DENSITY**. These characteristics provide the microfibre with its **MECHANICAL STRENGTH** and its **POWERFUL ABSORBING POWER**.

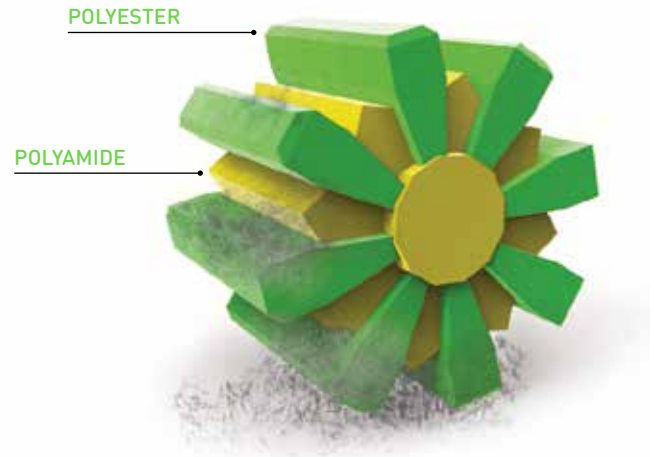

THICKNESS

Microfiber is twice as thin as silk, three times finer than cotton having a density equal to or less than 1 decitex*.

Due to its thinness, **THE MICROFIBER THREAD ENTERS DEEP INTO CRACKS OF THE MOST IRREGULAR SURFACES,**

Able to remove even the smallest particles of dirt and dust.

* the Decitex "dtex" corresponds to 1 g over 10 km and indicates how many meters of a certain quantity are contained in one gram of weight.

THICKNESS OF THE YARNS:

- **POLYPRO MONOFILAMENT** (46 dtex) \varnothing 80 μ m
- **HUMAN HAIR** (51 dtex) \varnothing 70 μ m
- **POLYESTER MONOFILAMENT** (44 dtex) \varnothing 64 μ m
- **WOOL** (26 dtex) \varnothing 50 μ m
- **CLASSIC POLYESTER** (4 dtex) \varnothing 19 μ m
- **COTTON** (3,2 dtex) \varnothing 16,5 μ m
- **SILK** (1,17 dtex) \varnothing 12,9 μ m
- **POLYESTER MICROFIBER** (0,78 dtex) \varnothing 8,5 μ m
- **POLYESTER MICROFIBER** (0,56 dtex) \varnothing 7,2 μ m
- **POLYESTER MICROFIBER** (0,30 dtex) \varnothing 5,3 μ m
- **MICROFIBER 80/20** (0,20 dtex) \varnothing 4,4 μ m
- **MICROFIBER 70/30** (0,15 dtex) \varnothing 3,8 μ m
- **SPIDER SILK** (0,14 dtex) \varnothing 3,6 μ m



If compared with classic fibers, the microfibre has a higher **MECHANICAL CAPACITY** on dirt removal: **ITS HIGH DENSITY ALLOWS IT TO REMOVE ANY TYPE OF DIRT.**

DENSITY

THE HIGHER THE DENSITY, THE HIGHER THE ABSORBING CAPACITY.

The fibers number per square centimeter denotes a microfibre's excellent cleaning performance.

From 100.000 to 250.000 fibers, this high number of fibers reflects high quality and high performances.

The weaving of the microfibre creates a network of free space, **AN EXTENSIVE NETWORK**, whose density allows it to absorb superficial dirt faster.

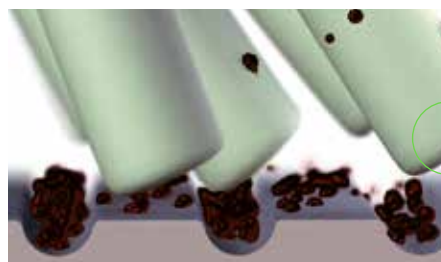

Classic Fiber

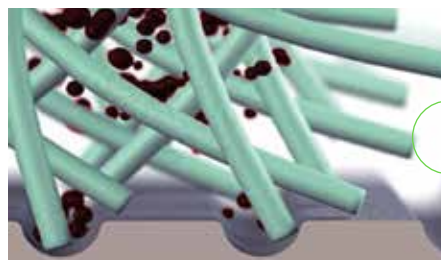

Microfiber

BENEFITS



CLEANING

Very strong cleaning power and highly effective on micro dirt **even without detergents.**



SAVING

Saves time and labor (minimum 30%) thanks to its extreme lightness and cleaning ability. **Excellent quality/price ratio.**



USE

It can be used on all surfaces **even those that are more delicate.**



LONG LASTING

Microfibre can be **regenerated several times** with a simple washing (manual or in the washing machine) keeping its characteristics unaltered.



RESULT

Very absorbent compared to traditional fibers and dries quickly.



ENVIRONMENT

Saving water and quantity of chemical product, **reducing the environmental impact.**

TIPS LAUNDERING INSTRUCTIONS

01 WASH AT HIGH TEMPERATURE

[194° F / 90° C if requested].

02 WASH WITH OTHER MICROFIBER PRODUCTS.

For best results keep them separate from other textiles.

03 DO NOT USE BLEACH

as it may shorten fibers life.

04 DO NOT USE FABRIC SOFTNER

as it tends to take away the positive charge.

05 DO NOT USE CHLORINE

06 TUMBLE DRY IF NECESSARY

But if possible leave it dry naturally.

07 "CONTROLLED" ENVIRONMENTAL IMPACT

Also available microfibre coming from post-consumer PET recycling (Re-Mop).

MAX WASHING TEMPERATURE 90° C

DO NOT USE BLEACH

USE TUMBLE DRYER



PATENT IPC

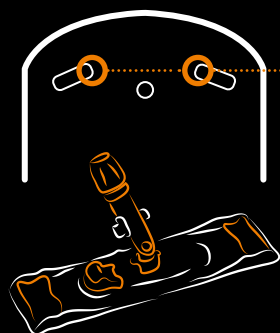

Flap with 2 HOLES

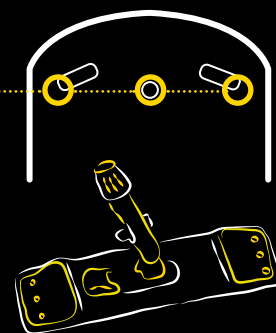

Flap with 3 HOLES

MAXIMUM COMPATIBILTY

SPECIAL FLAPS



SPEEDCLEAN / BOOK

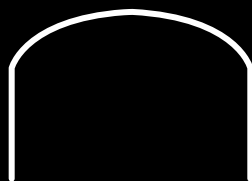

Flap WITHOUT HOLES



OLYMPIC / ONE

Innovations

01



SPECIAL FLAP

Details

02

- **NEW IPC SPECIAL FLAPS:**
3 different flaps types benefits in one.
- **EXTREME COMPATIBILITY**
- **UNIQUE SOLUTION IN THE MARKET**
(IPC patented)
- **SUITABLE FOR FRAMES**
that require flaps without holes,
with 2 holes or 3 holes.

Microfibres

03

- RE-MOP
- SUPACLE
- DUAL PERFORMANCE
- SHARK
- CORAL
- DEEP SNOW
- ONLY SCRUB
- SNOW
- HYGIENE
- SPOT
- PREMIUM HYGIENE
- LOOP
- PATH



LOOP ECL

EcolabelUE is the European Union ecological quality label that, based on a system of scientific selective criteria, certifies the low environmental impact of the product throughout the entire life cycle.

BY CHOOSING ECOLABEL YOU ARE HELPING MINIMISE THE USE OF HARMFUL SUBSTANCES.



LOOP ECL



100% Polyester

White closed loop micro-fibre captures and traps more dirt in the fabric thereby preventing the particulate from being released. The capillarity and density of the fibres give the product high absorbency. It can be used to clean floors, both damp and wet, and it is recommended for washing and disinfection with pre-soaked systems. Supports in H&L tear present with six different colors to differentiate the areas of use.

SURFACES

- Studded
- Cement
- Terracotta
- Rubber
- Granite
- Porcelain Stone
- Linoleum
- Marble
- Single-fired tilers
- Tile
- Stone
- Pvc



APPLICATION AREAS



SPECIFICATIONS



DEGREE OF DIRT

CODE	DIMENSION	UNIT	SUPPORT TYPE	UNIT PRICE
FRAN02000 - FRAN02001 - FRAN02002 FRAN02003 - FRAN02004 - FRAN02005	40 x 11 cm	50	H&L Strappo	€ 6,30
FRAN02020 - FRAN02021 - FRAN02022 FRAN02023 - FRAN02024 - FRAN02025	60 x 11 cm	50	H&L Strappo	€ 8,00
FRAN02030 - FRAN02031 - FRAN02032 FRAN02033 - FRAN02034 - FRAN02035	80 x 11 cm	50	H&L Strappo	€ 11,20
FRAN02040 - FRAN02041 - FRAN02042 FRAN02043 - FRAN02044 - FRAN02045	100 x 11 cm	50	H&L Strappo	€ 14,10



RECOMMENDED FRAMES



RAIL / SLIDE



ALUVEL



DUPLEX



OLYMPIC



CURVY

RE-MOP



100% Post-consumer recycled polyester

The world's first recycled polyester mop with yarn certified Global Recycled Standard (GRS). 100% recycled polyester yarn produced from post-consumer combined with a hook and loop fasteners support. Its closed end yarn allows to capture and hold more dirt inside its structure thus avoiding its dispersion.



APPLICATION AREAS



SPECIFICATIONS



DEGREE OF DIRT

SURFACES

- | | |
|----------|--------------|
| Bolted | Pvc |
| Cement | Rubber |
| Cotto | Sandstone |
| Granite | Single-fired |
| Linoleum | Stone |
| Marble | Tiles |

COMPATIBLE WITH

CODE	CM	UNITS/BOX	TYPE	COMPATIBLE WITH		UNIT PRICE
				FRAME	CODE	
FRAN01659	40 x 11	50	HOOK AND LOOP FASTENERS	RAIL / SLIDE	ATAPA00034	€ 6,00
				DUPLIX	ATPA00080 - 0015	
				ALUVEL	ATPA00125	

SUPACLE

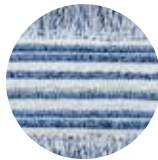
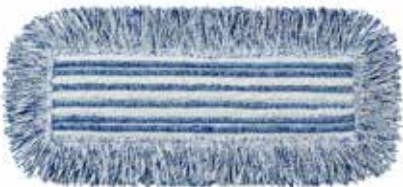

75% Polyester
25% Polypropylene

Microfibre with a high mechanical component due to the particular conformation of the warp weft. Extraordinary collection of coarse dirt thanks to its perimeter fringes.



APPLICATION AREAS



SPECIFICATIONS



DEGREE OF DIRT

SURFACES

- | | |
|------------------|--------------|
| Cotto | Pvc |
| Granite | Resin |
| Linoleum | Sandstone |
| Marble | Single-fired |
| Natural Wood | Tiles |
| Prefinished Wood | |

COMPATIBLE WITH

CODE	CM	UNITS/BOX	TYPE	COMPATIBLE WITH		UNIT PRICE
				FRAME	CODE	
FRAN01634	42 x 11	50	HOOK AND LOOP FASTENERS	RAIL / SLIDE	ATAPA00034	€ 8,75
				DUPLIX	ATPA00080 - 0015	
				ALUVEL	ATPA00125	

DUAL PERFORMANCE

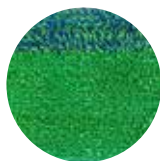

50% Microfiber
30% Polyester
20% Polypropylene



APPLICATION AREAS



SPECIFICATIONS

Innovative microfiber able to perform two operations in one: sweeping and washing.

Dirt gets quickly removed with the special blue and green front strip and retained inside the fiber, without dirtying the cusps - at the same time, the rear part allows a perfect surface wash.



DEGREE OF DIRT

SURFACES

- Bolted
- Cotto
- Linoleum
- Pvc
- Resin
- Sandstone
- Single-fired
- Tiles

COMPATIBLE WITH

CODE	CM	UNITS/BOX	TYPE	FRAME	CODE	UNIT PRICE
FRAN01639	42 x 11	50	HOOK AND LOOP FASTENERS	RAIL / SLIDE	ATAPA00034	€ 7,55
				DUPLIX	ATPA00080 - 0015	
				ALUVEL	ATPA00125	

SHARK

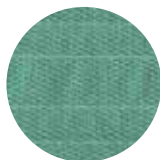

70% Microfiber (of which 70% PES 30% PA)
30% Polyurethane



APPLICATION AREAS



SPECIFICATIONS

Its special microfibre textile weave in relief - combined with polyurethane, make this multi-purpose mop a valuable tool.

Made with latest generation special fibers. It flows, cleans deeply and dries quickly.



DEGREE OF DIRT

SURFACES

- Granite
- Linoleum
- Marble
- Pvc
- Resin
- Sandstone
- Single-fired
- Steel
- Tiles

COMPATIBLE WITH

CODE	CM	UNITS/BOX	TYPE	FRAME	CODE	UNIT PRICE
FRAN01644	40 x 11	50	HOOK AND LOOP FASTENERS	RAIL / SLIDE	ATAPA00034	€ 6,80
				DUPLIX	ATPA00080 - 0015	
				ALUVEL	ATPA00125	

CORAL



100% Polyester



APPLICATION AREAS



SPECIFICATIONS

The exclusive texture of this microfibre ensures extraordinarily deep cleaning together with an high degree of residue removal.

The particular micro loop that characterizes this flat mop makes it a best seller.



DEGREE OF DIRT

SURFACES

- Bolted
- Cotto
- Linoleum
- Pvc
- Resin
- Sandstone
- Single-fired
- Tiles

COMPATIBLE WITH

CODE	CM	UNITS/BOX	TYPE	FRAME	CODE	UNIT PRICE
FRAN01642	40 x 11	50	HOOK AND LOOP FASTENERS	RAIL / SLIDE	ATAPA00034	€ 7,00
				DUPLIX	ATPA00080 - 0015	
				ALUVEL	ATPA00125	

DEEP SNOW

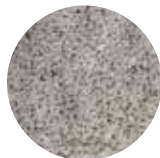

100% Polyester

Microfiber mixed with medium pile, suitable for washing. The excellent degree of smoothness and high absorbency power grant an effective cleaning result in the retention and removal of dirt due to its unique design.

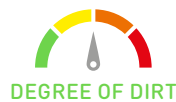

SURFACES

- Bolted
- Cotto
- Linoleum
- Natural Wood
- Prefinished Wood
- Pvc
- Resin
- Sandstone
- Single-fired
- Tiles

CODE	DIGIT FLAP COLOR	CM	UNITS/BOX	TYPE	COMPATIBLE WITH		UNIT PRICE
					FRAME	CODE	
FRAN01474		40 x 13	50	POCKETS	SANI SIMPLE	ATPA00069 - 1506	€ 8,35
FRAN01475		50 x 17	50		SANI SIMPLE	ATPA00055 - 1506	€ 9,95
FRAN01476	● 0005	42 x 11	50	POCKETS & "SPECIAL FLAP"	AUTOMATIK / NO TOUCH	ATPA00063	€ 8,45
FRAN01477	● 0002 ● 0009 ● 0004	40 x 13	50		NEW SANI	ATPA00064	€ 8,65
FRAN01478	● 0005 ● 0002	40 x 13	50	POCKETS & "SPECIAL FLAPS"	OLYMPIC / ONE / SPEEDCLEAN / BOOK	ATPA00066 ATPA00012	€ 8,85
FRAN01480	● 0009 ● 0004 ○ 0001	50 x 17	50		SPEEDCLEAN / BOOK	ATPA00014	€ 10,05
FRAN01481	● 0005 ● 0002 ● 0009	40 x 13	50	ONLY "SPECIAL FLAPS"	OLYMPIC / ONE / SPEEDCLEAN / BOOK	ATPA00066 ATPA00012	€ 8,35
FRAN01483	● 0004 ○ 0001	50 x 17	50		SPEEDCLEAN / BOOK	ATPA00014	€ 9,95
FRAN01484	● 0005 ● 0002 ● 0009	40 x 13	50	POCKETS & "SPECIAL FLAPS". MOP VERSION "DELUXE"	OLYMPIC / ONE / SPEEDCLEAN / BOOK	ATPA00066 ATPA00012	€ 9,85
FRAN01486	● 0004 ○ 0001	50 x 17	50		SPEEDCLEAN / BOOK	ATPA00014	€ 11,10
FRAN01487		40 x 11	50	HOOK AND LOOP FASTENERS	RAIL / SLIDE	ATPA00034	
					DUPLEX	ATPA00080 - 0015	€ 7,65
					ALUVEL	ATPA00125	
FRAN01488		60 x 11	50		RAIL / SLIDE	ATPA00037	€ 11,10
FRAN01489		80 x 11	50		RAIL / SLIDE	ATPA00038	€ 14,65
FRAN01490		100 x 11	50		RAIL / SLIDE	ATPA00033	€ 17,70

*Deluxe version is equipped with internal special sponge layer for extra absorbency and long lasting.

Color Coding refers to the color of the "SPECIAL FLAPS".

ONLY SCRUB

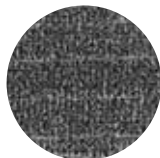

20% Polyester
80% Polyamide

Black abrasive microfibre suitable for removing encrusted dirt with a double passage action: abrasive and absorbent with the other fringe.
Recommended for non-slip surfaces and structured floors both for spot and deep cleaning.
Excellent smoothness on all types of floor and easy to rinse.

APPLICATION AREAS

DEGREE OF DIRT

SURFACES
Sandstone
Tiles

SPECIFICATIONS

CODE	DIGIT FLAP COLOR	CM	UNITS/BOX	TYPE	COMPATIBLE WITH		UNIT PRICE
					FRAME	CODE	
FRAN01508		40 x 13	50	POCKETS	SANI SIMPLE	ATPA00069 - 1506	€ 10,50
FRAN01509		50 x 17	50		SANI SIMPLE	ATPA00055 - 1506	€ 12,10
FRAN01510	● 0005	42 x 11	50	POCKETS & "SPECIAL FLAPS"	AUTOMATIK / NO TOUCH	ATPA00063	€ 10,60
FRAN01511	● 0002 ● 0009 ● 0004	40 x 13	50		NEW SANI	ATPA00064	€ 10,80
FRAN01512	● 0005 ● 0002 ● 0009	40 x 13	50	POCKETS & "SPECIAL FLAPS"	OLYMPIC / ONE / SPEEDCLEAN / BOOK	ATPA00066 ATPA00012	€ 11,10
FRAN01514	● 0004 ○ 0001	50 x 17	50		SPEEDCLEAN / BOOK	ATPA00014	€ 12,30
FRAN01515	● 0005 ● 0002 ● 0009	40 x 13	50	ONLY "SPECIAL FLAPS"	OLYMPIC / ONE / SPEEDCLEAN / BOOK	ATPA00066 ATPA00012	€ 10,50
FRAN01517	● 0004 ○ 0001	50 x 17	50		SPEEDCLEAN / BOOK	ATPA00014	€ 12,10
FRAN01518	● 0005 ● 0002 ● 0009	40 x 13	50	POCKETS & "SPECIAL FLAPS". MOP VERSION "DELUXE"	OLYMPIC / ONE / SPEEDCLEAN / BOOK	ATPA00066 ATPA00012	€ 12,10
FRAN01520	● 0004 ○ 0001	50 x 17	50		SPEEDCLEAN / BOOK	ATPA00014	€ 13,40
FRAN01521		40 x 11	50	HOOK AND LOOP FASTENERS	RAIL / SLIDE	ATPA00034	€ 8,85
					DUPLEX	ATPA00080 - 0015	
FRAN01522		60 x 11	50		ALUVEL	ATPA00125	
FRAN01523		80 x 11	50		RAIL / SLIDE	ATPA00037	€ 12,20
FRAN01524		100 x 11	50		RAIL / SLIDE	ATPA00038	€ 15,75
					RAIL / SLIDE	ATPA00033	€ 19,00

*Deluxe version is equipped with internal special sponge layer for extra absorbency and long lasting.
Color Coding refers to the color of the "SPECIAL FLAPS".

SNOW



100% Polyester

White short pile microfiber with good sliding effect, suitable for wet/dump (washing) and dry (dusting) cleaning. The excellent fluidity ensures effective cleaning results in removing dirt on almost all types of floors.



SURFACES

- Cotto
- Granite
- Linoleum
- Marble
- Natural Wood
- Prefinished Wood
- Pvc
- Resin
- Sandstone
- Steel
- Tiles

CODE	DIGIT FLAP COLOR	CM	UNITS/BOX	TYPE	COMPATIBLE WITH		UNIT PRICE
					FRAME	CODE	
FRAN01258		40 x 13	50	POCKETS	SANI SIMPLE	ATPA00069 - 1506	€ 6,30
FRAN01259		50 x 17	50		SANI SIMPLE	ATPA00055 - 1506	€ 7,85
FRAN01361	● 0005 ● 0002	42 x 11	50	POCKETS & "SPECIAL FLAP"	AUTOMATIK / NO TOUCH	ATPA00063	€ 6,20
FRAN01362	● 0009 ● 0004	40 x 13	50		NEW SANI	ATPA00064	€ 6,60
FRAN01202	● 0005 ● 0002	40 x 13	50	POCKETS & "SPECIAL FLAPS"	OLYMPIC / ONE / SPEEDCLEAN / BOOK	ATPA00066 ATPA00012	€ 6,80
FRAN01204	● 0009 ● 0004 ○ 0001	50 x 17	50		SPEEDCLEAN / BOOK	ATPA00014	€ 8,85
FRAN01205	● 0005 ● 0002	40 x 13	50	ONLY "SPECIAL FLAPS"	OLYMPIC / ONE / SPEEDCLEAN / BOOK	ATPA00066 ATPA00012	€ 6,10
FRAN01207	● 0009 ● 0004 ○ 0001	50 x 17	50		SPEEDCLEAN / BOOK	ATPA00014	€ 8,25
FRAN01208	● 0005 ● 0002	40 x 13	50	POCKETS & "SPECIAL FLAPS". MOP VERSION "DELUXE"	OLYMPIC / ONE / SPEEDCLEAN / BOOK	ATPA00066 ATPA00012	€ 7,75
FRAN01210	● 0009 ● 0004 ○ 0001	50 x 17	50		SPEEDCLEAN / BOOK	ATPA00014	€ 10,05
FRAN00974		40 x 11	50	HOOK AND LOOP FASTENERS	RAIL / SLIDE	ATPA00034	
					DUPLEX	ATPA00080 - 0015	€ 5,60
					ALUVEL	ATPA00125	
FRAN01035		60 x 11	50		RAIL / SLIDE	ATPA00037	€ 6,70
FRAN01262		80 x 11	50		RAIL / SLIDE	ATPA00038	€ 9,75
FRAN01263		100 x 11	50	RAIL / SLIDE	ATPA00033	€ 12,00	

*Deluxe version is equipped with internal special sponge layer for extra absorbency and long lasting.

Color Coding refers to the color of the "SPECIAL FLAPS".

HYGIENE



100% Polyester

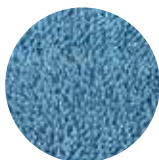

Blue microfiber with cusp twisting with a high removal power on porous floors and with grouts, bleach and aggressive detergent resistant.

Particularly suitable for washing and disinfection of environments in where the risk of contamination is medium-high.



APPLICATION AREAS



SPECIFICATIONS



SURFACES

Cotto	Pvc
Granite	Resin
Linoleum	Sandstone
Marble	Steel
Natural Wood	Tiles
Prefinished Wood	

CODE	DIGIT FLAP COLOR	CM	UNITS/BOX	TYPE	COMPATIBLE WITH		UNIT PRICE
					FRAME	CODE	
FRAN01264		40 x 13	50	POCKETS	SANI SIMPLE	ATPA00069 - 1506	€ 6,60
FRAN01265		50 x 17	50		SANI SIMPLE	ATPA00055 - 1506	€ 8,55
FRAN01363	● 0005 ● 0002	42 x 11	50	POCKETS & "SPECIAL FLAP"	AUTOMATIK / NO TOUCH	ATPA00063	€ 6,70
FRAN01364	● 0009 ● 0004	40 x 13	50		NEW SANI	ATPA00064	€ 6,90
FRAN01211	● 0005 ● 0002 ● 0009	40 x 13	50	POCKETS & "SPECIAL FLAPS"	OLYMPIC / ONE / SPEEDCLEAN / BOOK	ATPA00066 ATPA00012	€ 7,15
FRAN01213	● 0004 ○ 0001	50 x 17	50		SPEEDCLEAN / BOOK	ATPA00014	€ 9,25
FRAN01217	● 0005 ● 0002 ● 0009	40 x 13	50	POCKETS & "SPECIAL FLAPS". MOP VERSION "DELUXE"	OLYMPIC / ONE / SPEEDCLEAN / BOOK	ATPA00066 ATPA00012	€ 7,85
FRAN01219	● 0004 ○ 0001	50 x 17	50		SPEEDCLEAN / BOOK	ATPA00014	€ 10,05
FRAN00981		40 x 11	50	HOOK AND LOOP FASTENERS	RAIL / SLIDE	ATPA00034	€ 6,20
					DUPLEX	ATPA00080 - 0015	
					ALUVEL	ATPA00125	
FRAN01046		60 x 11	50		RAIL / SLIDE	ATPA00037	€ 7,85
FRAN01268		80 x 11	50		RAIL / SLIDE	ATPA00038	€ 10,60
FRAN01269		100 x 11	50		RAIL / SLIDE	ATPA00033	€ 13,30

*Deluxe version is equipped with internal special sponge layer for extra absorbency and long lasting.

Color Coding refers to the color of the "SPECIAL FLAPS".

SPOT

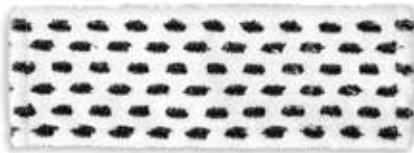

85% Polyester
15% Polyamide

The combination of white short pile microfiber (suitable for any type of surface) and the black abrasive spots (to rub the stubborn stains) ensures an excellent result in removing even the most difficult soil.



APPLICATION AREAS



SURFACES

Bolted
Cotto
Rubber

Steel
Stone
Tiles



SPECIFICATIONS

CODE	DIGIT FLAP COLOR	CM	UNITS/BOX	TYPE	COMPATIBLE WITH		UNIT PRICE
					FRAME	CODE	
FRAN01270		40 x 13	50	POCKETS	SANI SIMPLE	ATPA00069 - 1506	€ 7,00
FRAN01271		50 x 17	50		SANI SIMPLE	ATPA00055 - 1506	€ 9,25
FRAN01365	● 0005	42 x 11	50	POCKETS & "SPECIAL FLAP"	AUTOMATIK / NO TOUCH	ATPA00063	€ 7,35
FRAN01366	● 0002 ● 0009 ● 0004	40 x 13	50		NEW SANI	ATPA00064	€ 7,55
FRAN01220	● 0005 ● 0002	40 x 13	50	POCKETS & "SPECIAL FLAPS"	OLYMPIC / ONE / SPEEDCLEAN / BOOK	ATPA00066 ATPA00012	€ 7,65
FRAN01222	● 0009 ● 0004 ○ 0001	50 x 17	50		SPEEDCLEAN / BOOK	ATPA00014	€ 10,30
FRAN01223	● 0005 ● 0002 ● 0009	40 x 13	50	ONLY "SPECIAL FLAPS"	OLYMPIC / ONE / SPEEDCLEAN / BOOK	ATPA00066 ATPA00012	€ 6,90
FRAN01225	● 0004 ○ 0001	50 x 17	50		SPEEDCLEAN / BOOK	ATPA00014	€ 9,25
FRAN01226	● 0005 ● 0002 ● 0009	40 x 13	50	POCKETS & "SPECIAL FLAPS" - MOP VERSION "DELUXE"	OLYMPIC / ONE / SPEEDCLEAN / BOOK	ATPA00066 ATPA00012	€ 8,45
FRAN01228	● 0004 ○ 0001	50 x 17	50		SPEEDCLEAN / BOOK	ATPA00014	€ 11,00
FRAN00982		40 x 11	50		RAIL / SLIDE	ATPA00034	€ 6,50
					DUPLEX	ATPA00080 - 0015	
FRAN00866		60 x 11	50	HOOK AND LOOP FASTENERS	ALUVEL	ATPA00125	
FRAN01274		80 x 11	50		RAIL / SLIDE	ATPA00037	€ 8,25
FRAN01275		100 x 11	50		RAIL / SLIDE	ATPA00038	€ 11,00
					RAIL / SLIDE	ATPA00033	€ 13,80

*Deluxe version is equipped with internal special sponge layer for extra absorbency and long lasting.

Color Coding refers to the color of the "SPECIAL FLAPS".

PREMIUM HYGIENE



100% Polyester with nylon inserts



Blue microfiber short pile with slightly abrasive inserts for a thorough and deep cleaning, bleach and aggressive detergents resistant.

This particular fabric structure makes it ideal for environments where the risk of bacterial contamination is high.



APPLICATION AREAS



SPECIFICATIONS



DEGREE OF DIRT

SURFACES

Bolted
Linoleum
Pvc

Rubber
Sandstone
Stone

CODE	DIGIT FLAP COLOR	CM	UNITS/BOX	TYPE	COMPATIBLE WITH		UNIT PRICE
					FRAME	CODE	
FRAN01276		40 x 13	50	POCKETS	SANI SIMPLE	ATPA00069 - 1506	€ 8,25
FRAN01277		50 x 17	50		SANI SIMPLE	ATPA00055 - 1506	€ 10,60
FRAN01367	● 0005	42 x 11	50	POCKETS & "SPECIAL FLAP"	AUTOMATIK / NO TOUCH	ATPA00063	€ 8,35
FRAN01368	● 0002 ● 0009 ● 0004	40 x 13	50		NEW SANI	ATPA00064	€ 8,55
FRAN01229	● 0005 ● 0002 ● 0009	40 x 13	50	POCKETS & "SPECIAL FLAPS"	OLYMPIC / ONE / SPEEDCLEAN / BOOK	ATPA00066 ATPA00012	€ 8,65
FRAN01231	● 0004 ○ 0001	50 x 17	50		SPEEDCLEAN / BOOK	ATPA00014	€ 11,40
FRAN01235	● 0005 ● 0002 ● 0009	40 x 13	50	POCKETS & "SPECIAL FLAPS" MOP VERSION "DELUXE"	OLYMPIC / ONE / SPEEDCLEAN / BOOK	ATPA00066 ATPA00012	€ 9,35
FRAN01237	● 0004 ○ 0001	50 x 17	50		SPEEDCLEAN / BOOK	ATPA00014	€ 12,30
FRAN00983		40 x 11	50		RAIL / SLIDE	ATPA00034	€ 6,10
					DUPLEX	ATPA00080 - 0015	
FRAN01061		60 x 11	50	HOOK AND LOOP FASTENERS	ALUVEL	ATPA00125	€ 7,65
					RAIL / SLIDE	ATPA00037	
FRAN01280		80 x 11	50		RAIL / SLIDE	ATPA00038	€ 10,60
FRAN01281		100 x 11	50		RAIL / SLIDE	ATPA00033	€ 13,30

*Deluxe version is equipped with internal special sponge layer for extra absorbency and long lasting.

Color Coding refers to the color of the "SPECIAL FLAPS".

LOOP



100% Polyester

The looped end yarn white microfiber allows to capture and holds more dirt inside its structure thus avoiding particulates dispersion. It can be used on all surfaces, wet and damp, and specifically in the pre-impregnated system.



APPLICATION AREAS



SPECIFICATIONS



SURFACES

- | | |
|----------|--------------|
| Bolted | Pvc |
| Cement | Rubber |
| Cotto | Sandstone |
| Granite | Single-fired |
| Linoleum | Stone |
| Marble | Tiles |

CODE	DIGIT FLAP COLOR	CM	UNITS/BOX	TYPE	COMPATIBLE WITH		UNIT PRICE
					FRAME	CODE	
FRAN01282		40 x 13	50	POCKETS	SANI SIMPLE	ATPA00069 - 1506	€ 7,65
FRAN01283		50 x 17	50		SANI SIMPLE	ATPA00055 - 1506	€ 10,05
FRAN01369	● 0005	42 x 11	50	POCKETS & "SPECIAL FLAP"	AUTOMATIK / NO TOUCH	ATPA00063	€ 8,35
FRAN01370	● 0002 ● 0009 ● 0004	40 x 13	50		NEW SANI	ATPA00064	€ 8,55
FRAN01238	● 0005 ● 0002 ● 0009	40 x 13	50		OLYMPIC / ONE / SPEEDCLEAN / BOOK	ATPA00066 ATPA00012	€ 8,65
FRAN01240	● 0004 ○ 0001	50 x 17	50	POCKETS & "SPECIAL FLAPS"	SPEEDCLEAN / BOOK	ATPA00014	€ 11,40
FRAN01241	● 0005 ● 0002 ● 0009	40 x 13	50		OLYMPIC / ONE / SPEEDCLEAN / BOOK	ATPA00066 ATPA00012	€ 7,45
FRAN01248	● 0004 ○ 0001	50 x 17	50	ONLY "SPECIAL FLAPS"	SPEEDCLEAN / BOOK	ATPA00014	€ 10,05

Color Coding refers to the color of the "SPECIAL FLAPS".

PATH



The short pile microfiber grants efficient dirt removal and the central band allows an effective collection of dust and dirt. Simultaneously, the outer side bands allow an easy and fast washing operations.

100% Polyester



APPLICATION AREAS



SPECIFICATIONS



SURFACES

- Cotto
- Granite
- Linoleum
- Marble
- Natural Wood
- Prefinished Wood
- Pvc
- Resin
- Sandstone
- Steel
- Tiles

CODE	DIGIT FLAP COLOR	CM	UNITS/BOX	TYPE	COMPATIBLE WITH		UNIT PRICE
					FRAME	CODE	
FRAN01249	● 0005	40 x 13	50	POCKETS & "SPECIAL FLAPS"	OLYMPIC / ONE / SPEEDCLEAN / BOOK	ATPA00066	€ 5,80
	● 0002					ATPA00012	
FRAN01251	● 0009	50 x 17	50		SPEEDCLEAN / BOOK	ATPA00014	€ 7,20
	● 0004						
FRAN01089	○ 0001	40 x 11	50	HOOK AND LOOP FASTENERS	RAIL / SLIDE	ATPA00034	€ 5,20
					DUPLEX	ATPA00080 - 0015	
					ALUVEL	ATPA00125	
FRAN01091		60 x 11	50		RAIL / SLIDE	ATPA00037	€ 6,20
FRAN01292		80 x 11	50	HOOK AND LOOP FASTENERS	RAIL / SLIDE	ATPA00038	€ 10,40
FRAN01293		100 x 11	50		RAIL / SLIDE	ATPA00033	€ 12,80

Color Coding refers to the color of the "SPECIAL FLAPS".

COPO

MOP REPLACEMENTS



SPECIFICATIONS

- Central baking: polyester
- Pockets: polyester
- Flaps: polypropylene
- Yarn: polyester, cotton

APPLICATION AREAS



CODE	DIGIT FLAP COLOR	CM	UNITS/BOX	TYPE	COMPATIBLE WITH		UNIT PRICE
					FRAME	CODE	
FRAN00469		40 x 13	50	POCKETS	SANI SIMPLE	ATPA00069 - 1506	€ 4,50
FRAN01301		50 x 17	50		SANI SIMPLE	ATPA00055 - 1506	€ 5,70
FRAN01373	● 0005 ● 0002	42 x 11	50	POCKETS & "SPECIAL FLAP"	AUTOMATIK / NO TOUCH	ATPA00063	€ 4,60
FRAN01374	● 0009 ● 0004	40 x 13	50		NEW SANI	ATPA00064	€ 4,90
FRAN01304	● 0005 ● 0002 ● 0009	40 x 13	50	POCKETS & "SPECIAL FLAP"	OLYMPIC / ONE / SPEEDCLEAN / BOOK	ATPA00066 ATPA00012	€ 5,10
FRAN01306	● 0004 ○ 0001	50 x 17	50		SPEEDCLEAN / BOOK	ATPA00014	€ 6,60
FRAN01307	● 0005 ● 0002 ● 0009	40 x 13	50	ONLY "SPECIAL FLAP"	OLYMPIC / ONE / SPEEDCLEAN / BOOK	ATPA00066 ATPA00012	€ 4,30
FRAN01309	● 0004 ○ 0001	50 x 17	50		SPEEDCLEAN / BOOK	ATPA00014	€ 5,70
FRAN00472		40 x 11	50	HOOK AND LOOP FASTENERS	RAIL / SLIDE	ATPA00034	
					DUPLEX	ATPA00080 - 0015	€ 4,00
					ALUVEL	ATPA00125	
FRAN00474		60 x 11	50		RAIL / SLIDE	ATPA00037	€ 5,80
FRAN00476		80 x 11	50		RAIL / SLIDE	ATPA00038	€ 8,55
FRAN00471		100 x 11	50		RAIL / SLIDE	ATPA00033	€ 9,95

RING

MOP REPLACEMENTS



SPECIFICATIONS

- Central baking: polyester
- Pockets: polyester
- Flaps: polypropylene
- Yarn: polyester, cotton

APPLICATION AREAS



CODE	DIGIT FLAP COLOR	CM	UNITS/BOX	TYPE	COMPATIBLE WITH		UNIT PRICE
					FRAME	CODE	
FRAN00134		40 x 13	50	POCKETS	SANI SIMPLE	ATPA00069 - 1506	€ 8,35
FRAN00401		50 x 17	50		SANI SIMPLE	ATPA00055 - 1506	€ 8,85
FRAN01313	● 0005 ● 0002	40 x 13	50	POCKETS & "SPECIAL FLAP"	OLYMPIC / ONE / SPEEDCLEAN / BOOK	ATPA00066 ATPA00012	€ 8,75
FRAN01315	● 0009 ● 0004 ○ 0001	50 x 17	50		SPEEDCLEAN / BOOK	ATPA00014	€ 11,40
FRAN01316	● 0005 ● 0002 ● 0009	40 x 13	50	ONLY "SPECIAL FLAP"	OLYMPIC / ONE / SPEEDCLEAN / BOOK	ATPA00066 ATPA00012	€ 8,15
FRAN01318	● 0004 ○ 0001	50 x 17	50		SPEEDCLEAN / BOOK	ATPA00014	€ 10,80

Color Coding refers to the color of the "SPECIAL FLAPS".

GREY

MOP REPLACEMENTS



SPECIFICATIONS

- Central baking: polyester
- Pockets: polyester
- Flaps: polypropylene
- Yarn: polyester, cotton, LOOP microfiber

APPLICATION AREAS



CODE	DIGIT FLAP COLOR	CM	UNITS/BOX	TYPE	COMPATIBLE WITH		UNIT PRICE
					FRAME	CODE	
FRAN00515		40 x 13	50	POCKETS	SANI SIMPLE	ATPA00069 - 1506	€ 5,50
FRAN01319		50 x 17	50		SANI SIMPLE	ATPA00055 - 1506	€ 7,15
FRAN01375	● 0005 ● 0002	42 x 11	50	POCKETS & "SPECIAL FLAP"	AUTOMATIK / NO TOUCH	ATPA00063	€ 5,70
FRAN01376	● 0009 ● 0004	40 x 13	50		NEW SANI	ATPA00064	€ 5,90
FRAN01322	● 0005 ● 0002 ● 0009	40 x 13	50	POCKETS & "SPECIAL FLAPS"	OLYMPIC / ONE / SPEEDCLEAN / BOOK	ATPA00066 ATPA00012	€ 6,00
FRAN01324	● 0004 ○ 0001	50 x 17	50		SPEEDCLEAN / BOOK	ATPA00014	€ 8,05
FRAN01325	● 0005 ● 0002 ● 0009	40 x 13	50	ONLY "SPECIAL FLAPS"	OLYMPIC / ONE / SPEEDCLEAN / BOOK	ATPA00066 ATPA00012	€ 5,50
FRAN01327	● 0004 ○ 0001	50 x 17	50		SPEEDCLEAN / BOOK	ATPA00014	€ 7,15
FRAN00519		40 x 11	50	HOOK AND LOOP FASTENERS	RAIL / SLIDE	ATPA00034	€ 4,80
					DUPLEX	ATPA00080 - 0015	
					ALUVEL	ATPA00125	
FRAN00522		60 x 11	50		RAIL / SLIDE	ATPA00037	€ 6,60
FRAN00524		80 x 11	50		RAIL / SLIDE	ATPA00038	€ 8,85
FRAN00518		100 x 11	50		RAIL / SLIDE	ATPA00033	€ 11,00

TUFTING EXPORT

MOP REPLACEMENTS



SPECIFICATIONS

- Central baking: polyester
- Pockets: polyester
- Lateral ribbon: polyester
- Yarn: polyester, cotton

APPLICATION AREAS



CODE	DIGIT FLAP COLOR	CM	UNITS/BOX	TYPE	COMPATIBLE WITH		UNIT PRICE
					FRAME	CODE	
FRAN00753		40 x 13	50	POCKETS	SANI SIMPLE	ATPA00069 - 1506	€ 6,80
FRAN01331		50 x 17	50		SANI SIMPLE	ATPA00055 - 1506	€ 7,45
FRAN01332	● 0005 ● 0002	40 x 13	50	POCKETS & "SPECIAL FLAPS"	OLYMPIC / ONE / SPEEDCLEAN / BOOK	ATPA00066 ATPA00012	€ 7,25
FRAN01334	● 0009 ● 0004 ○ 0001	50 x 17	50		SPEEDCLEAN / BOOK	ATPA00014	€ 9,85
FRAN01335	● 0005 ● 0002 ● 0009	40 x 13	50	ONLY "SPECIAL FLAPS"	OLYMPIC / ONE / SPEEDCLEAN / BOOK	ATPA00066 ATPA00012	€ 6,60
FRAN01337	● 0004 ○ 0001	50 x 17	50		SPEEDCLEAN / BOOK	ATPA00014	€ 7,45

Color Coding refers to the color of the "SPECIAL FLAPS".

COMBIMOP
MOP REPLACEMENTS



SPECIFICATIONS

- Central baking: polyester
- Flaps: polypropylene
- Yarn: Tufting Export, SNOW microfiber

APPLICATION AREAS



CODE	DIGIT FLAP COLOR	CM	UNITS/BOX	TYPE	COMPATIBLE WITH		UNIT PRICE
					FRAME	CODE	
FRAN00465		40 x 13	50	POCKETS	SANI SIMPLE	ATPA00069 - 1506	€ 9,35
FRAN00467		50 x 17	50		SANI SIMPLE	ATPA00055 - 1506	€ 10,50
FRAN01338	● 0005 ● 0002 ● 0009	40 x 13	50	POCKETS & "SPECIAL FLAPS"	OLYMPIC / ONE / SPEEDCLEAN / BOOK	ATPA00066 ATPA00012	€ 9,85
FRAN01340	● 0004 ○ 0001	50 x 17	50		SPEEDCLEAN / BOOK	ATPA00014	€ 12,80
FRAN01341	● 0005 ● 0002 ● 0009	40 x 13	50	ONLY "SPECIAL FLAPS"	OLYMPIC / ONE / SPEEDCLEAN / BOOK	ATPA00066 ATPA00012	€ 9,15
FRAN01343	● 0004 ○ 0001	50 x 17	50		SPEEDCLEAN / BOOK	ATPA00014	€ 14,00

TUFTING LIGHT
MOP REPLACEMENTS



SPECIFICATIONS

- Central baking: polyester
- Pockets: polyester
- Lateral ribbon: polyester
- Yarn: polyester, cotton

APPLICATION AREAS



CODE	DIGIT FLAP COLOR	CM	UNITS/BOX	TYPE	COMPATIBLE WITH		UNIT PRICE
					FRAME	CODE	
FRAN00348		40 x 13	50	POCKETS	SANI SIMPLE	ATPA00069 - 1506	€ 6,10
FRAN00352		50 x 17	50		SANI SIMPLE	ATPA00055 - 1506	€ 6,90
FRAN01344	● 0005 ● 0002 ● 0009	40 x 13	50	POCKETS & "SPECIAL FLAPS"	OLYMPIC / ONE / SPEEDCLEAN / BOOK	ATPA00066 ATPA00012	€ 6,60
FRAN01346	● 0004 ○ 0001	50 x 17	50		SPEEDCLEAN / BOOK	ATPA00014	€ 8,85
FRAN01347	● 0005 ● 0002 ● 0009	40 x 13	50	ONLY "SPECIAL FLAPS"	OLYMPIC / ONE / SPEEDCLEAN / BOOK	ATPA00066 ATPA00012	€ 5,90
FRAN01349	● 0004 ○ 0001	50 x 17	50		SPEEDCLEAN / BOOK	ATPA00014	€ 8,15

Color Coding refers to the color of the "SPECIAL FLAPS".

WHAT IS TRIOMOP?

IPC designs and produces cleaning solutions based on the consumers real needs, solutions granting extraordinary results.

TRIOMOP, THE NEW PATENT MOP REPLACEMENT

allows the user to perform three operations using just one mop which is divided into three sections.

Extremely easy and economic, Triomop is made of 3 sides of different materials (microfibers or cotton) to meet different requirements and result levels.

By varying the materials of the mop replacement, i.e. microfiber and cottonpolyester (open-end or looped), the mop washes and dries "simultaneously".

**BY USING ONLY ONE MOP
YOU CAN COVER THREE TIMES
THE SURFACE,
INCREASING ITS VERSATILITY.**



ADVANTAGES

- **EXCELLENT CLEANING RESULTS**
in removing both loose and attached dirt
- **VERY HIGH COVERAGE**
in terms of surface area (more than 40 m²)
- **UNIFORM DISTRIBUTION**
of detergents and reduced drying time
- **ERGONOMIC**
lightweight for a smooth operation
- **UNIVERSAL**
adaptable to all mop frames currently on the market
- **ENVIRONMENTALLY FRIENDLY**
an efficient mop reduces detergent use with better results
- **EXCELLENT PRICE-QUALITY RATIO**
essentially, 3 mops for the price of 2

TYPES and MEASUREMENTS

- **WITH POCKETS (40X13 - 50X17 CM)**
- **WITH HOOK AND LOOP FASTENERS (40X13 CM)**

(Mops of any personalized size or measurements are available upon request)



TESTED BY:

FIGR Istituto di Ricerca e di Controllo per Facility Management GmbH

HOW TO USE TRIOMOP?

SIDE C



SIDE B

SIDE A

METHOD OF USE 1

(for normal cleaning operations)

PHASE 1

During the cleaning process, side A of the mop ensures a greater degree of contact between the mop and the surface to be cleaned, allowing a more effective collection of dirt. At the same time, part B (microfiber cloth) collects dirt residue while absorbing both the cleaning product and the excess of moisture.

PHASE 2

After folding back side B, the cleaning procedure continues by refinishing the surface using side C, leaving the floor perfectly dry and streak-free.

METHOD OF USE 2

(cleaning particularly dirty surfaces)

PHASE 1

Start with the mop in a folded position so that only side C is used. Proceed with cleaning until the entire surface to be cleaned has been covered.

PHASE 2

Reposition the mop replacement by moving the handle upward, lift the frame and then push the mop to the floor so that both sides A and B are being used.

In addition to the cleaning performed by section A, part B (microfiber cloth) collects dirt residue while absorbing both the cleaning product and excess moisture.

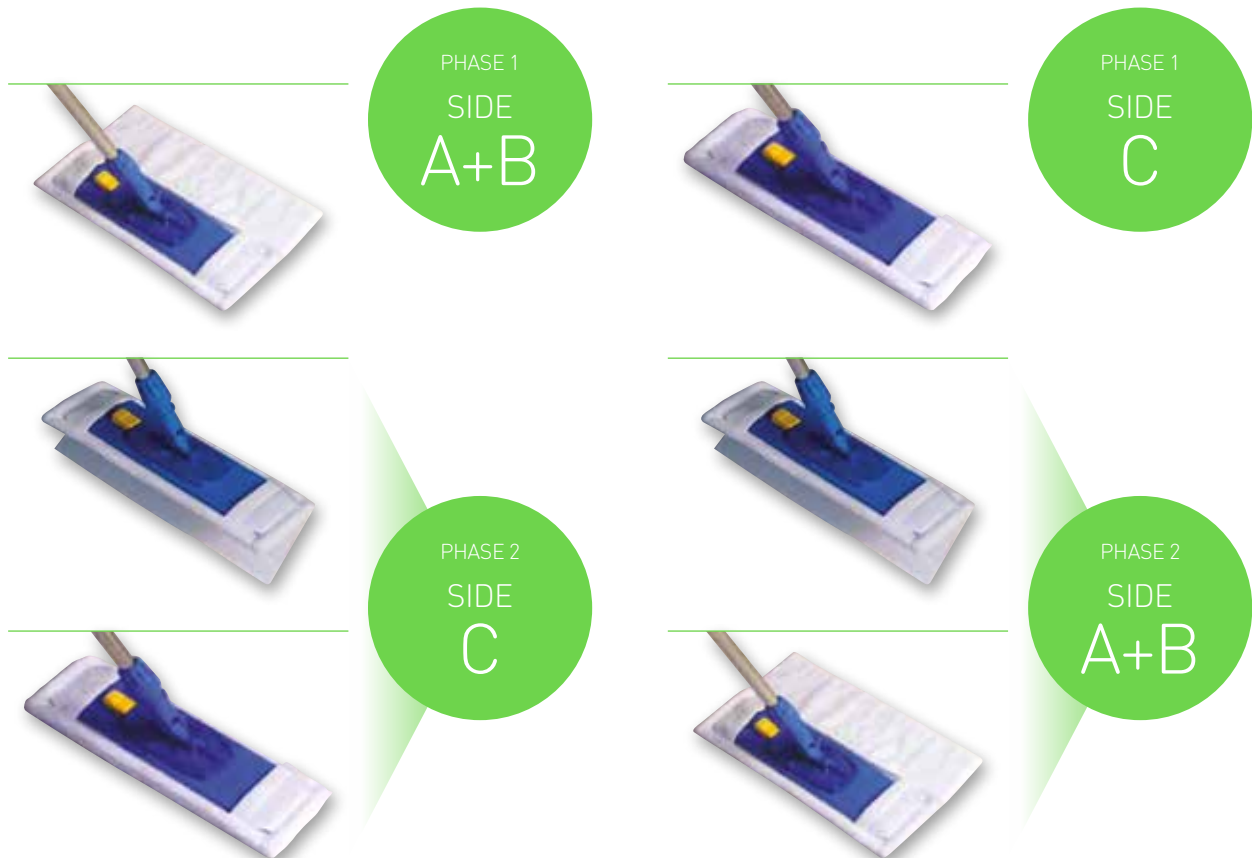

TRIOMOP ZEBRY
MOP REPLACEMENTS



SPECIFICATIONS

- SIDE A: Zebry microfiber
- SIDE B: Microfiber cloth
- SIDE C: Zebry microfiber

CODE	CM	UNITS/BOX	TYPE	COMPATIBLE WITH		UNIT PRICE
				FRAME	CODE	
FRAN00902	40 x 13	25	POCKETS	SANI SIMPLE	ATPA00069 - 1506	€ 14,95
				OLYMPIC / ONE	ATPA00066 ATPA00012	
FRAN01297	50 x 17	25	POCKETS	SANI SIMPLE	ATPA00055 - 1506	€ 18,60
FRAN01409	40 x 13	25	HOOK AND LOOP FASTENERS	RAIL / SLIDE	ATPA00034	€ 10,80
				DUPLEX	ATPA00080 - 0015	
				ALUVEL	ATPA00125	

TRIOMOP HYGIENE
MOP REPLACEMENTS



CODE	CM	UNITS/BOX	TYPE	COMPATIBLE WITH		UNIT PRICE
				FRAME	CODE	
FRAN01123	40 x 13	25	POCKETS	SANI SIMPLE	ATPA00069 - 1506	€ 12,20
				OLYMPIC / ONE	ATPA00066 ATPA00012	
FRAN01124	50 x 17	25	POCKETS	SANI SIMPLE	ATPA00055 - 1506	€ 16,25
FRAN01156	40 x 13	25	HOOK AND LOOP FASTENERS	RAIL / SLIDE	ATPA00034	€ 11,20
				DUPLEX	ATPA00080 - 0015	
				ALUVEL	ATPA00125	

COTTON STANDARD MOP



CODE	SIZE	UNITS	BAND	UNIT PRICE
MOPP00010 - 0001	350 g	60	-	€ 3,70
MOPP00013 - 0001	400 g	50	-	€ 4,00
MOPP00016 - 0001	450 g	50	-	€ 4,40
MOPP00020 - 0001	500 g	50	-	€ 4,80
MOPP00037 - 0001	350 g	60	✓	€ 4,30
MOPP00040 - 0001	400 g	50	✓	€ 4,50
MOPP00042 - 0001	450 g	50	✓	€ 5,00
MOPP00044 - 0001	500 g	50	✓	€ 5,40

COTTON STANDARD MOP
WITH LOOPED-ENDS



CODE	SIZE	UNITS	BAND	UNIT PRICE
MOPP00077 - 0001	350 g	60	✓	€ 4,40
MOPP00078 - 0001	400 g	50	✓	€ 4,70

EXPORT COTTON MOP



CODE	SIZE	UNITS	BAND	UNIT PRICE
MOPP00048 - 0001	350 g	60	-	€ 5,00
MOPP00049 - 0001	400 g	50	-	€ 5,70
MOPP00050 - 0001	450 g	50	-	€ 6,30
MOPP00051 - 0001	500 g	50	-	€ 7,00
MOPP00059 - 0001	350 g	60	✓	€ 5,50
MOPP00061 - 0001	400 g	50	✓	€ 6,10
MOPP00062 - 0001	450 g	50	✓	€ 6,80
MOPP00063 - 0001	500 g	50	✓	€ 7,45

ECOMOP NON WOVEN



CODE	SIZE	UNITS	BAND	UNIT PRICE
MOPP00144 - 0001	220 g	50	-	€ 3,70
MOPP00145 - 0001	250 g	40	-	€ 3,90
MOPP00146 - 0001	280 g	40	-	€ 4,20

ECOMOP NON WOVEN

TWISTED STRIPES



CODE	SIZE	UNITS	BAND	UNIT PRICE
MOPP00151 - 0001	220 g	50	-	€ 3,90
MOPP00154 - 0001	250 g	50	-	€ 4,00
MOPP00156 - 0001	280 g	50	-	€ 4,20

MICRO-KEN



CODE	SIZE	UNITS	BAND	UNIT PRICE
MOPP00102 - 0005	350 g	25	-	€ 13,10

PLASTIC MOP HOLDER



CODE
MPVR12982

● IP15 ● IP09

UNITS
200

UNIT PRICE
€ 3,25

CODE
MPVR94539

● IP15 ● IP06
● 0009 ● 0004 ● 0002

CONF
200

UNIT PRICE
€ 3,25



PLASTIC MOP HOLDER

STAINLESS STEEL HOOK

CODE
MPVR12983

● IP15 ● IP09

UNITS
200

UNIT PRICE
€ 8,85



CODE
MPVR94354

● IP15

UNITS
200

UNIT PRICE
€ 8,85



WASHING MOP BAG



70 LT.

CODE
SACC00001

○ 0001

UNIT PRICE
€ 8,35

CODE
SACC00009

● 1501 ● 0201
● 0301 ● 0401

UNIT PRICE
€ 8,35

90 LT.

CODE
SACC00027

○ 0001

UNIT PRICE
€ 11,80

CODE
SACC00002

● 0501 ● 0201

UNIT PRICE
€ 11,80

STANDARD THIN COTTON MOP

UNIVERSAL CONNECTOR



CODE	SIZE	UNITS	CONNECTOR TYPE	UNIT PRICE
MOPP00165	220 g	50	UNIVERSAL	€ 2,75
MOPP00167	250 g	50	UNIVERSAL	€ 3,05
MOPP00168	300 g	50	UNIVERSAL	€ 3,35

● 0015 ● 0002 ● 0009 ● 0004 ○ 0001

STANDARD THICK COTTON MOP

UNIVERSAL CONNECTOR



CODE	SIZE	UNITS	CONNECTOR TYPE	UNIT PRICE
MOPP00170	220 g	50	UNIVERSAL	€ 2,75
MOPP00173	250 g	50	UNIVERSAL	€ 3,05

● 0015 ● 0002 ● 0009 ● 0004 ○ 0001

STANDARD THIN COTTON MOP

ITALIAN THREAD CONNECTOR



CODE	SIZE	UNITS	CONNECTOR TYPE	UNIT PRICE
MOPP00003	200 g	50	THREAD	€ 2,25
MOPP00004	240 g	50	THREAD	€ 2,75
MOPP00005	280 g	50	THREAD	€ 3,15
MOPP00030	330 g	50	THREAD	€ 3,60

● 0015 ● 0002 ● 0009 ● 0004 ○ 0001

STANDARD THICK COTTON MOP

ITALIAN THREAD CONNECTOR



CODE	SIZE	UNITS	CONNECTOR TYPE	UNIT PRICE
MOPP00026	200 g	50	THREAD	€ 2,35
MOPP00028	240 g	50	THREAD	€ 3,05
MOPP00029	280 g	50	THREAD	€ 3,25
MOPP00099	330 g	50	THREAD	€ 3,80

● 0015 ● 0002 ● 0009 ● 0004 ○ 0001

ECOMOP NON WOVEN

ITALIAN THREAD CONNECTOR



CODE	SIZE	UNITS	CONNECTOR TYPE	UNIT PRICE
MOPP00143	160 g	50	THREAD	€ 2,45

○ 0001 ● 0015 ● 0002 ● 0009 ● 0004

ECOMOP NON WOVEN TWISTED

ITALIAN THREAD CONNECTOR



CODE	SIZE	UNITS	CONNECTOR TYPE	UNIT PRICE
MOPP00148	140 g	50	THREAD	€ 2,45
MOPP00149	160 g	50	THREAD	€ 2,85
MOPP00150	200 g	50	THREAD	€ 3,15

○ 0001 ● 0015 ● 0002 ● 0009 ● 0004

MICRO-SOCKET

ITALIAN THREAD CONNECTOR



CODE	SIZE	UNITS	CONNECTOR TYPE	UNIT PRICE
MOPP00101 - 0005	200 g	20	THREAD	€ 8,25

ELLISSE MOP BUCKET WITH SIEVE

- **PORTABLE AND LIGHTWEIGHT:**
with extra-strong handle
- **EASY:** with integrated sieve

ELLISSE MOP BUCKET 12 LITRES

CODE
SECC00017

● 0015 ● 0002
● 0009 ● 0004

UNITS/BOX
10

UNIT PRICE
€ 10,30



ELLISSE MOP BUCKET BLACK IS GREEN™ 12 LITRES

CODE
SECC00017 - 0099

UNITS/BOX
10

UNIT PRICE
€ 9,05



ELLISSE MOP BUCKET 15 LITRES

CODE
SECC00020

● 0015 ● 0002
● 0009 ● 0004

UNITS/BOX
10

UNIT PRICE
€ 16,45



ELLISSE MOP BUCKET BLACK IS GREEN™ 15 LITRES

CODE
SECC00020 - 0099

UNITS/BOX
10

UNIT PRICE
€ 14,45



SIEVE FOR ELLISSE MOP BUCKET

CODE
STRI00002

● 0015 ● 0002
● 0009 ● 0004

UNIT PRICE
€ 2,45



SIEVE FOR ELLISSE MOP BUCKET

CODE
STRI00002 - 0099

UNIT PRICE
€ 2,05



TRIGGY vs TRIGGY DETACHABLE

TRIGGY

CODE
ATPA00111

● 0015 ● 0002
● 0009 ● 0004

DIMENSION
44x12x150 cm

UNIT
1

UNIT PRICE
€ 54,10



TRIGGY DETACHABLE

CODE
ATPA00147

● 0015 ● 0002
● 0009 ● 0004

DIMENSION
44x12x150 cm

UNIT
1

UNIT PRICE
€ 64,70

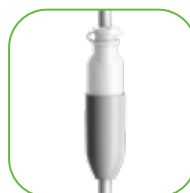

DETAILS

- **PROFESSIONAL CLEANING SYSTEM**
ready to use
- **EASY AND PRACTICAL:** ideal for offices, healthcare (operating rooms), hotels, restaurants, bus and trains
- **DISPENSES THE SOLUTION DIRECTLY ON THE SOIL**
through its push button
- **LONG USE** 1,25 lt. refillable solution tank with soft cap
- **ERGONOMIC HANDLE** that speeds operations and reduces efforts
- **INTERCHARGABLE FRAME**

DETAILS

- **FAST FILLING:** of the removable 500 ml tank
- **ERGONOMIC HANDLE**
- **ECO-FRIENDLY:**
use only the needed cleaning solution
- **INTERCHARGABLE FRAME**
- **PRACTICAL AND ECONOMIC**

ACCESSORIES:

TANK FOR TRIGGY DETACHABLE

CODE
PMVR06334-0001

CAPACITY
500 ml

UNITS
1

UNIT PRICE
€ 11,30



KNOB FOR TRIGGY DETACHABLE

CODE
MPVR12006

● 0015 ● 0002
● 0009 ● 0004

CAPACITY
500 ml

UNITS
1

UNIT PRICE
€ 3,25



NEW

CURVY

cleaning without efforts

CURVY

Curvy is the innovative ultra-fast floor cleaning system that makes cleaning faster, more ergonomic and more efficient.

The speed, ergonomics, lightness and sturdiness that feature Curvy, make it an essential tool for each operator.

Ergonomic

With the intuitive natural **S-shaped motion** of Curvy, the rotation of the wrist and arm is no more required and this allows to drastically reduce the strain placed upon the operator's shoulders, arms and wrists, otherwise present in traditional equipment, limiting the **Repetitive Strain Injuries (R.S.I.)**.

Curvy ensures the operator to adopt a correct posture and contributes to his well-being.

Available in two models:

- 01. Telescopic handle version
- 02. Three-pieces handle version

CODE	MEASURES	HANDLE TYPE	PESO	UNIT PRICE
KTRI06019	40 CM	3 pieces	0,618 KG	€ 20,40
KTRI06020	60 CM	3 pieces	0,711 KG	€ 22,60
KTRI06021	40 CM	Telescopic	0,690 KG	€ 22,40
KTRI06022	60 CM	Telescopic	0,783 KG	€ 24,60

01. TELESCOPIC HANDLE

02. THREE-PIECES HANDLE

WOODEN HANDLE
WITH HOLE

CODE MANI00006 CODE MANI00007
 DIMENSION mm Ø23 x 130 cm DIMENSION mm Ø23 x 150 cm
 UNITS 30 UNITS 30
 UNIT PRICE € 3,80 UNIT PRICE € 4,10



WOODEN HANDLE
WITH ITALIAN THREAD

CODE MANI00008 CODE MANI00009
 DIMENSION mm Ø23 x 130 cm DIMENSION mm Ø23 x 150 cm
 UNITS 30 UNITS 30
 UNIT PRICE € 3,80 UNIT PRICE € 4,10



PAINTED HANDLE
WITH ITALIAN THREAD

CODE MANI00005
 ● 0002
 DIMENSION mm Ø22 x 130 cm
 UNITS 50
 UNIT PRICE € 2,85



ALUMINUM HANDLE
WITH HOLE

CODE MANI00029
 ● 0015 ● 0002
 ● 0009 ● 0004
 DIMENSION mm Ø23 x 145 cm
 UNITS 60
 UNIT PRICE € 6,20



ALUMINUM HANDLE
WITH ITALIAN THREAD

CODE MANI00030
 ● 0015 ● 0002
 ● 0009 ● 0004
 DIMENSION mm Ø23 x 145 cm
 UNITS 60
 UNIT PRICE € 6,90



GLASS FIBER HANDLE
WITH HOLE

CODE MANI00035
 ● 0009
 DIMENSION mm Ø23,5 x 145 cm
 UNITS 60
 UNIT PRICE € 11,50



ALUMINUM TELESCOPIC HANDLE
WITH HOLE

CODE MANI00033 CODE MANI00032
 ● 0005 ● 0005
 ● 0009 ● 0009
 ● 0002 ● 0002
 ● 0004 ● 0004
 DIMENSION 2 x 70 cm DIMENSION 2 x 100 cm
 UNITS 20 UNITS 20
 UNIT PRICE € 10,50 UNIT PRICE € 11,20



2 PCS. CHROMED HANDLE
WITH HOLE

CODE MANI00001 CODE MANI00002
 ● 0009 ● 0009
 DIMENSION Ø22 x 130 cm DIMENSION Ø22 x 145 cm
 UNITS 50 UNITS 50
 UNIT PRICE € 7,65 UNIT PRICE € 8,45



COMPONENTS:

COLOURED GRIP

CODE MAN000003
 ● 0015 ● 0002
 ● 0009 ● 0004
 UNIT PRICE € 0,82



* For all handles except for Aluminum Telescopic Handle and Ergonomic Telescopic Handle

HANDLES HOLDER

CODE MPVR94925-IP06
 DIMENSION 50 x 7 x 4,5 h cm UNIT PRICE € 19,10
 UNITS 1



POLYPROPYLENE FLOOR SQUEEGEE
BLACK IS GREEN™



CODE	DIGIT	CM	UNITS	UNIT PRICE
ATPA00023	9999	45	10	€ 6,00
ATPA00024	9999	55	10	€ 6,80
ATPA00025	9999	75	10	€ 9,25



Recommended for general applications

POLYPROPYLENE FLOOR SQUEEGEE



CODE	DIGIT	CM	UNITS	UNIT PRICE
ATPA00026	● 1515	35	10	€ 5,60
ATPA00023	● 1515	45	10	€ 6,40
ATPA00024	● 1515	55	10	€ 7,15
ATPA00025	● 1515	75	10	€ 9,55



Recommended for general applications

METAL FLOOR SQUEEGEE



CODE	CM	UNITS	UNIT PRICE
ATPA00020	45	10	€ 7,25
ATPA00021	55	10	€ 8,75
ATPA00022	75	10	€ 12,10



Suitable for industry applications

NYLON FLOOR SQUEEGEE
(WITH BLACK RUBBER)



CODE	DIGIT	CM	UNITS	UNIT PRICE
ATPA00101	● 1506 ● 0206	35	10	€ 7,65
ATPA00098	● 1506 ● 0206	45	10	€ 8,55
ATPA00099	● 1506 ● 0206	55	10	€ 9,65
ATPA00100	● 1506 ● 0206	75	10	€ 12,10



Recommended for general applications

NYLON FLOOR SQUEEGEE
(WITH WHITE RUBBER)



CODE	DIGIT	CM	UNITS	UNIT PRICE
ATPA00043	○ 0101	45	10	€ 11,40
ATPA00044	○ 0101	55	10	€ 12,80
ATPA00045	○ 0101	75	10	€ 16,05



Suitable for food sector

NYLON FLOOR SQUEEGEE
(WITH RED RUBBER)



CODE	DIGIT	CM	UNITS	UNIT PRICE
ATPA00039	● 0206	45	10	€ 14,75
ATPA00040	● 0206	55	10	€ 16,15
ATPA00041	● 0206	75	10	€ 19,80



Suitable for oils and oily substances

For the combinations with the handles see TAB D - page 14

TELESCOPIC MUSTIK FLOOR SQUEEGEE
WITH TELESCOPIC HANDLE

CODE
ATPA00178 - IP06

DIMENSION
35 cm

UNITS
1

UNIT PRICE
€ 17,60



SWIVEL HANDLE PAD HOLDER

CODE
ATPA00076

● IP15

DIMENSION
23 cm

UNITS/BOX
10

UNIT PRICE
€ 14,35



HAND PAD HOLDER

CODE
ATPA00078

● IP15

DIMENSION
23,5 cm

UNITS/BOX
10

UNIT PRICE
€ 15,35



ABRASIVE PAD

CODE
SPUG00022

○ 0001

DIMENSION
25 cm

UNITS/BOX
10

UNIT PRICE
€ 2,85

CODE
SPUG00001

● 0013 ● 0003 ● 0029



GLASS MOP PAD

CODE
FRAN01001 - 0003

DIMENSION
24 cm

UNITS/BOX
50

UNIT PRICE
€ 4,80



SURFACES

- Glass
- Mirrors

SNOW PAD

CODE
TESS00276

DIMENSION
24 cm

UNITS/BOX
50

UNIT PRICE
€ 4,30



SURFACES

- Marble
- White Boards

SPOT PAD

CODE
TESS00290

DIMENSION
24 cm

UNITS/BOX
50

UNIT PRICE
€ 4,50



SURFACES

- Tiles
- Wood
- Ceramic
- Mosaic

ZEBRY PAD

CODE
TESS00316

DIMENSION
24 cm

UNITS/BOX
50

UNIT PRICE
€ 4,70



SURFACES

- Multipurpose
- Aluminum
- Steel
- Marble
- Mosaic

COLOURED SNOW PAD

CODE
FRAN00609

● 0005 ● 0002
● 0003 ● 0004

DIMENSION
24 cm

UNITS/BOX
100

UNIT PRICE
€ 4,80



SNOW is the most appreciated microfiber type among our customers. Very soft, it could be used on all surfaces, damp and wet but even dry.

SURFACES:

- Marble
- White Boards

SNOW MITTS

CODE
FRAN00503

● 0005 ● 0002
● 0003 ● 0004
○ 0001

UNITS/BOX
25

UNIT PRICE
€ 7,00



A WIDE RANGE MICROFIBRE ROUND PADS

Used with a scrubber dryer or with a single disc machine, the microfibre round pads are effective in the cleaning and sanitation of surfaces, such as wood, carpet, marble and steel.

ZEBRY

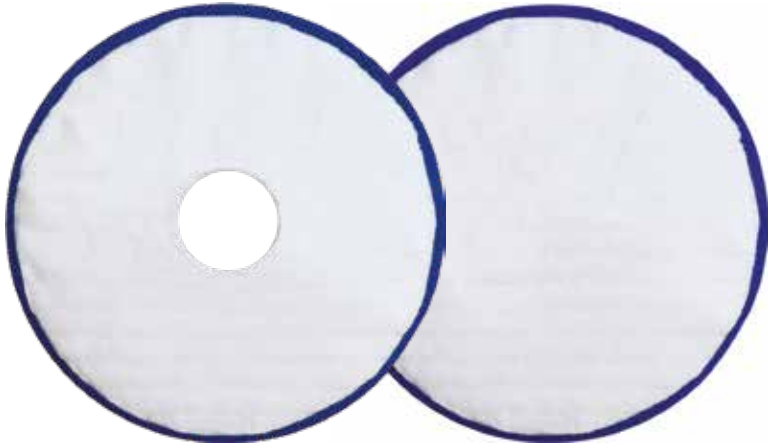

100% Polyester

Provided with short pile, alternate with stripes, this microfiber soft white round pad is suitable to collect large amount of dirt during the daily floorcare activities. Its softness makes it perfect for a constant cleaning of delicate floors, ensuring high performances at the same time.

SURFACES

Cotto
Granite
Linoleum
Marble
Natural Wood
Prefinished Wood

Pvc
Resin
Sandstone
Single-fired
Steel
Tiles

WASHING INSTRUCTIONS



WASHING PROGRAM:
Mop 60° C Standard



WASHING TEMPERATURE:
60°C



WASHING CYCLES:
500



CENTRIFUGAL TURNS:
Max 1100 turns/min



WASHING TIPS:
Do not use fabric softeners,
bleach and chlorine



DRYING:
Normal drying (max 50° C).
Do not tumble dry

CODE	CM	UNITS	UNIT PRICE
WITHOUT HOLE			
MOPP00257	Ø 33 cm / 13"	10	€ 10,80
MOPP00229	Ø 43 cm / 17"	10	€ 14,00
MOPP00332	Ø 51 cm / 20"	10	€ 16,85
WITH HOLE			
MOPP00228	Ø 33 cm / 13"	10	€ 10,80
MOPP00330	Ø 43 cm / 17"	10	€ 14,00
MOPP00331	Ø 51 cm / 20"	10	€ 16,85

DEEP SNOW

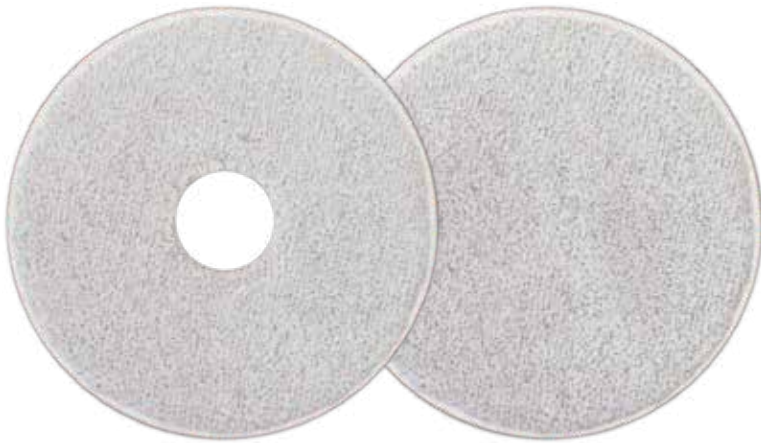

100% Polyester

This mixed medium-cut microfibre round pad is high performant and long-lasting. Its special texture ensures effective surfaces maintenance and dirt removal.

SURFACES

Cotto
Granite
Linoleum
Marble
Natural Wood
Prefinished Wood

Pvc
Resin
Sandstone
Single-fired
Steel
Tiles

WASHING INSTRUCTIONS



WASHING PROGRAM:
Mop 60° C Standard



WASHING TEMPERATURE:
60°C



WASHING CYCLES:
500



CENTRIFUGAL TURNS:
Max 1100 turns/min



WASHING TIPS:
Do not use fabric softeners,
bleach and chlorine



DRYING:
Normal drying (max 50° C).
Do not tumble dry

CODE	CM	UNITS	UNIT PRICE
WITHOUT HOLE			
MOPP00311	Ø 33 cm / 13"	10	€ 9,85
MOPP00312	Ø 43 cm / 17"	10	€ 12,60
MOPP00313	Ø 51 cm / 20"	10	€ 14,35
WITH HOLE			
MOPP00314	Ø 33 cm / 13"	10	€ 9,85
MOPP00315	Ø 43 cm / 17"	10	€ 12,60
MOPP00316	Ø 51 cm / 20"	10	€ 14,35

ONLY SCRUB

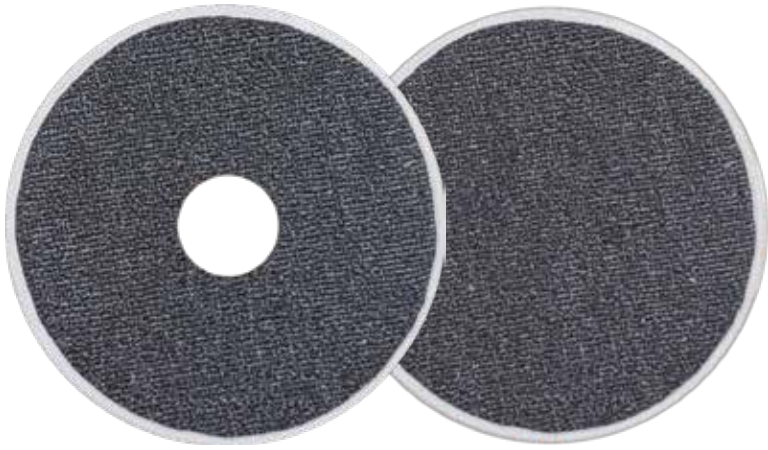

80% Polyamide, 20% Polyester

Ideal for the removal of persistent dirt, this abrasive black microfiber round pad is very resistant and aggressive in the application. Only Scrub is suitable for all anti-slip surfaces in the food industry.

SURFACES

Sandstone
Single-fired
Tiles

WASHING INSTRUCTIONS



WASHING PROGRAM:
Mop 60° C Standard



WASHING TEMPERATURE:
60°C



WASHING CYCLES:
500



CENTRIFUGAL TURNS:
Max 1100 turns/min



WASHING TIPS:
Do not use fabric softeners,
bleach and chlorine



DRYING:
Do not tumble dry

CODE	CM	UNITS	UNIT PRICE
WITHOUT HOLE			
MOPP00305	Ø 33 cm / 13"	10	€ 14,35
MOPP00306	Ø 43 cm / 17"	10	€ 19,10
MOPP00307	Ø 51 cm / 20"	10	€ 26,90
WITH HOLE			
MOPP00308	Ø 33 cm / 13"	10	€ 14,35
MOPP00309	Ø 43 cm / 17"	10	€ 19,10
MOPP00310	Ø 51 cm / 20"	10	€ 26,90

MOQUETTE



85% Polyester, 15% Polypropylene

Equipped with special abrasive strips and closed looped-end yarn, Moquette is suitable for textile surfaces. Easy to use, this is perfect on medium-large carpets and moquette. It quickly dries the surfaces, allowing to walk immediately on them.

SURFACES

Moquette

WASHING INSTRUCTIONS



WASHING PROGRAM:
Pads 40° C Standard



WASHING TEMPERATURE:
40°C



WASHING CYCLES:
500



CENTRIFUGAL TURNS:
Max 1100 turns/min



WASHING TIPS:
Do not use fabric softeners,
bleach and chlorine



DRYING:
Normal drying (max 50° C).
Do not tumble dry

CODE	CM	UNITS	UNIT PRICE
MOPP00320	Ø 33 cm / 13"	10	€ 15,85
MOPP00343	Ø 38 cm / 15"	10	€ 23,15
MOPP00319	Ø 43 cm / 17"	10	€ 28,55
MOPP00321	Ø 51 cm / 20"	10	€ 34,90

SHINE

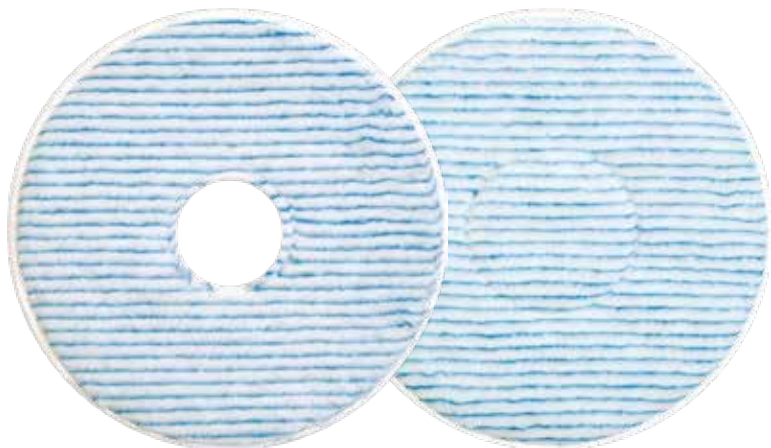

66% Polyester, 34% Polyamide

Through its fibers particularly suitable for polishing, this high quality soft microfiber round pad is indicated for the cleaning and maintenance of all delicate and waxed floors.

SURFACES

Cotto	Pvc
Granite	Resin
Linoleum	Sandstone
Marble	Single-fired
Natural Wood	Steel
Prefinished Wood	Tiles

WASHING INSTRUCTIONS



WASHING PROGRAM:
Pads 40° C Standard



WASHING TEMPERATURE:
40°C



WASHING CYCLES:
500



CENTRIFUGAL TURNS:
Max 1100 turns/min



WASHING TIPS:
Do not use fabric softeners,
bleach and chlorine



DRYING:
Normal drying (max 50° C).
Do not tumble dry

CODE	CM	UNITS	UNIT PRICE
WITHOUT HOLE			
MOPP00246	Ø 33 cm / 13"	10	€ 10,60
MOPP00202	Ø 43 cm / 17"	10	€ 15,15
MOPP00206	Ø 51 cm / 20"	10	€ 19,60
WITH HOLE			
MOPP00200	Ø 33 cm / 13"	10	€ 10,60
MOPP00203	Ø 43 cm / 17"	10	€ 15,15
MOPP00207	Ø 51 cm / 20"	10	€ 19,60

TREE

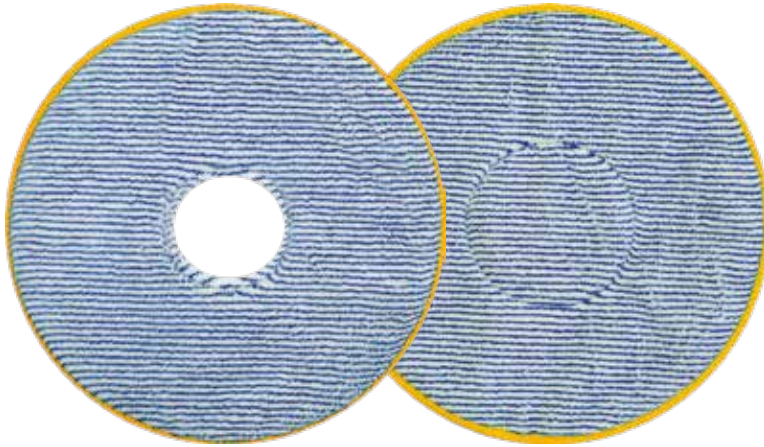

80% Polyamide, 20% Acetate

This microfiber white – light blue round pad with short pile is the ideal solution for daily surfaces cleaning when a specific treatment is not required. It is particularly suitable for microporous surfaces.

SURFACES

Cotto
Granite
Linoleum
Marble
Pvc

Resin
Sandstone
Single-fired
Tiles

WASHING INSTRUCTIONS



WASHING PROGRAM:
Mop 60° C Standard



WASHING TEMPERATURE:
60°C



WASHING CYCLES:
300



CENTRIFUGAL TURNS:
Max 1100 turns/min



WASHING TIPS:
Do not use fabric softeners,
bleach and chlorine



DRYING:
Normal drying (max 50° C).
Do not tumble dry

CODE	CM	UNITS	UNIT PRICE
WITHOUT HOLE			
MOPP00302	Ø 33 cm / 13"	10	€ 14,20
MOPP00303	Ø 43 cm / 17"	10	€ 21,45
MOPP00221	Ø 51 cm / 20"	10	€ 28,55
WITH HOLE			
MOPP00213	Ø 33 cm / 13"	10	€ 14,20
MOPP00217	Ø 43 cm / 17"	10	€ 21,45
MOPP00222	Ø 51 cm / 20"	10	€ 28,55

BEE



55% Polyamide, 45% Polyester

Bee is a microfiber long hair round pad, equipped with abrasive inserts of several hardness. It is indicated for the removal of the most stubborn dirt, trapped inside the white soft microfiber with excellent cleaning results.

SURFACES

Granite
Marble
Resin

Sandstone
Single-fired
Tiles

WASHING INSTRUCTIONS



WASHING PROGRAM:
Mop 60° C Standard



WASHING TEMPERATURE:
60°C



WASHING CYCLES:
300



CENTRIFUGAL TURNS:
Max 1100 turns/min



WASHING TIPS:
Do not use fabric softeners,
bleach and chlorine



DRYING:
Normal drying (max 50° C).
Do not tumble dry

CODE	CM	UNITS	UNIT PRICE
WITHOUT HOLE			
MOPP00188	Ø 33 cm / 13"	10	€ 13,10
MOPP00191	Ø 43 cm / 17"	10	€ 19,60
MOPP00195	Ø 51 cm / 20"	10	€ 26,70
WITH HOLE			
MOPP00189	Ø 33 cm / 13"	10	€ 13,10
MOPP00192	Ø 43 cm / 17"	10	€ 19,60
MOPP00196	Ø 51 cm / 20"	10	€ 26,70



COTTON-POLYESTER BONNET MOP

CODE	DIGIT	CM	UNITS	UNIT PRICE
MOPP00069	○0001	Ø 43 cm / 17"	10	€ 18,00
DOUBLE LOOPED END				
MOPP00070	○0001	Ø 43 cm / 17"	10	€ 28,55

CLOTHS & SPONGES

Created for the “cleaning professional team” and not only, the “cloths & sponges line” consists in a wide range of high quality and professional products, satisfying many and different customers’ needs.

CLOTHS

BENEFITS

- **IDEAL FOR EVERY TYPE OF SURFACES SUCH AS FOR EXAMPLE REFLECTING OR ROUGH ONES.**

RANGE

The line of products has been split into 5 categories:

- **MICROFIBER**
- **MULTI - PURPOSE**
- **FLOORS**
- **WINDOWS**
- **COMPOSTABLE**
- **SPONGES**

METHOD OF USE

PHASE 1

Choose the color of the cloth according to the cleaning operation and area.

Folding the cloth in 4 sections obtaining 8 damp surfaces in order to use the most of it.

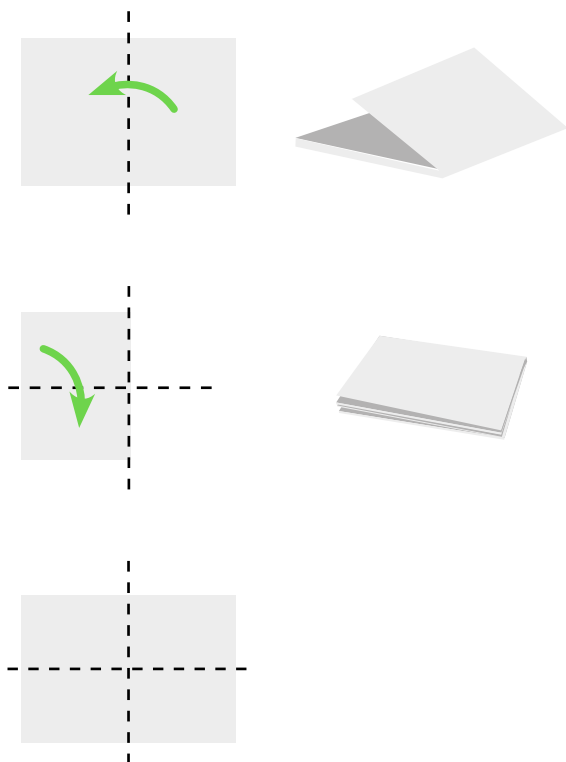

PHASE 2

Spray the solution on the cloth.

Humidify the entire surface of the cloth, both sides.

IT IS PREFERABLY spraying the solution directly on the cloth and not on the surface (unless there are special stains).

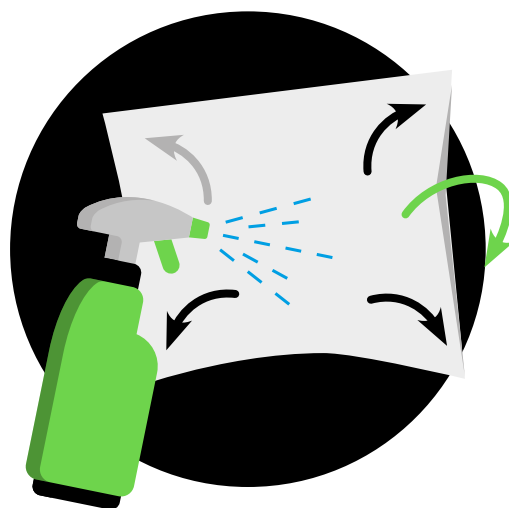

At the end, wash the clothes and put them to dry.

MICROFIBRE CLOTHS SHOULD BE WASHED IN THE WASHING MACHINE AT HIGH TEMPERATURE WITH THE APPROPRIATE CLEANER.

MICRO SILVER

Various preventative measures based primarily on cleaning and disinfection operations are put into effect in order to limit the risk of bacteria cross-contamination and the spreading of infection.

While these methods are effective in reducing risk, their effect is only temporary and the formation of colonies of bacteria remains a real threat. In this context, antimicrobial materials have recently been introduced - a real innovation in both the prevention and management of risk situations in areas with bacteria contamination risk.

WHAT IT IS

MICRO SILVER is a microfiber cloth treated with an antimicrobial material based upon silver ion nanotechnology, a method new to the cleaning sector, but with amazing potential.

HOW IT WORKS

The silver ions have a strong oxidizing power: they destroy bacteria and fungi by oxidizing the cellular membrane and inhibiting the development of pathogens, thus limiting the transfer of bacteria from one area to another.

RESULTS

This method guarantees the nearly complete destruction of all bacteria trapped within the cloth after 10 minutes. Its antibacterial qualities remain effective, even after 500 washes.

CHARACTERISTICS

COMPOSITION:

80% polyester,
20% polyamide

WEIGHT:

308 gr/sqm

COLORS:

blue
red
yellow
green

PACKAGING:

individually wrapped,
50 pieces per carton

BENEFITS

- **ECOLOGICAL**
eliminates 95% of germs/ bacteria, with great saving of chemical products
- **SAFE**
presents no danger to the user thanks to the harmlessness of silver; no risk of irritation or allergy upon contact with skin
- **EFFECTIVE IN 10 MINUTES KILLS GERMS/ BACTERIA**
thereby drastically reducing bacterial cross-contamination
- **PRICE EXCELLENT PRICE-QUALITY RATIO**
- **PRODUCT LIFE**
Bacterial treatment lasts up to 500 washes (at high temperature)
- **LONG LIFE OF CLOTH**

TEST

Effectiveness tests were conducted for the following pathogens:

BACTERIA:

Test report 1: **STAPHYLOCOCCUS AUREUS**
Test report 2: **PSEUDOMONAS AERUGINOSA**
Test report 3: **KLEBSIELLA PNEUMONIA**
Test report 4: **ESCHERICHIA COLI**
Test report 5: **SALMONELLA**

FUNGI:

Test report 6: **ASPERGILLUS FUMIGATUS**
Test report 7: **PENICILLIUM NIDULANS**

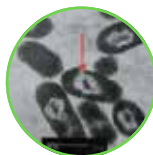

Organism's cell

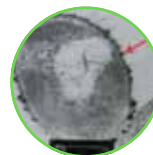

Nano silver on cell wall

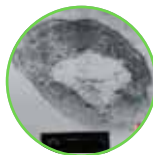

Organism's cell



Nano silver on cell wall

MULTI UTILITY

MICROFIBRE AND MULTI PURPOSE CLOTH

CODE
PANN00026

● 0005 ● 0011
● 0003 ● 0004

DIMENSION
35x38 cm

PACK
1 pc

UNIT PRICE
€ 3,60



FEATURES:

- Microfiber and multi-purpose cloth, ideal for glass and steel
- Degreaser, absorbent
- Antibacterial
- Detergent proof
- Streak free cleaning

MICRO PLUS

MICROFIBRE CLOTH
(80% POLYESTER - 20% POLYAMIDE)

CODE
PANN00023

● 0005 ● 0002
● 0003 ● 0004

DIMENSION
40x40 cm

PACK
1 pc

UNIT PRICE
€ 2,65



FEATURES:

- High absorbency
- Detergent proof
- Streak free cleaning
- To be used damp or dry
- Long lasting

MICRO KOMBI

MICROFIBRE CLOTH

CODE
PANN00045

● 0015 ● 0040

DIMENSION
37x35 cm

PACK
10 pcs

UNIT PRICE
€ 4,10



FEATURES:

- Good removal of grease and stubborn fingerprints
- Good absorbent and resisting
- Very fast on the surface
- Ideal for steel and glass surfaces
- Washable in dishwasher

MICRO SILVER

ANTIBACTERIAL MICROFIBRE CLOTH
(80% POLYESTER - 20% POLYAMIDE)

CODE
PANN00025

● 0055 ● 0052
● 0053 ● 0054

DIMENSION
40x40 cm

PACK
10 pcs

UNIT PRICE
€ 3,55



FEATURES:

- Antibacterial microfiber cloth
- High absorbency
- Detergent proof
- To be used damp or dry

MICRO PLUS EXPORT

MICROFIBRE CLOTH
(70% POLYESTER - 30% POLYAMIDE)

CODE
PANN00118

● 0005 ● 0002
● 0003 ● 0004

DIMENSION
40x40 cm

PACK
5 pcs

UNIT PRICE
€ 3,35



FEATURES:

- High absorbency
- Detergent proof
- Non lascia aloni
- Ideale per l'utilizzo a secco o a umido
- Resistente nel tempo

MICRO UP

MULTI-PURPOSE CLOTH
(70% POLYESTER - 30% POLYAMIDE)

CODE
PANN00070

● 0005 ● 0002
● 0003 ● 0004

DIMENSION
37x37 cm

PACK
20 pcs

UNIT PRICE
€ 2,15



MICRO LIGHT

NON WOVEN MICROFIBRE CLOTH
(50% POLYESTER - 50% POLYAMIDE)

CODE
PANN00022

● 0005 ● 0002
● 0003 ● 0004

DIMENSION
36x40 cm

PACK
10 pcs

UNIT PRICE
€ 1,32



FEATURES:

- Non woven microfiber cloth ideal for daily cleaning
- Quick and easy handling
- Ideal for delicate surfaces
- Ideal for drying kitchenware

MICRO PLUS MAXI

MICROFIBER FLOOR CLOTH
(80% POLYESTER - 20% POLYAMIDE)

CODE
PANN00019

● 0003

DIMENSION
60x40 cm

PACK
10 pcs

UNIT PRICE
€ 4,60



FEATURES:

- High absorbency
- Streak free cleaning
- Ideal for all type of floors
- To be used damp or dry
- Soft and easy handling

CLOTHS & SPONGES / CLOTHS

BLUE DREAM

MICROFIBRE AND MULTI PURPOSE CLOTH
(70% POLYESTER - 30% POLYAMIDE)

CODE
PANN00044

● 0005 ● 0011
● 0003 ● 0004

DIMENSION
40x40 cm

PACK
5 pcs

UNIT PRICE
€ 2,45



FEATURES:

- Wash and dry without leaving traces
- Very fast on the surface
- Ideal for glossy surfaces such as glasses mirrors or any other lacquered surfaces

CLOTHS & SPONGES / FLOORS CLEANING

ECO FLOOR

FLOOR CLOTH
(80% VISCOSE, 20% POLYPROPYLENE)

CODE
PANN00057

DIMENSION
50x70 cm

PACK
100 pcs

UNIT PRICE
€ 1,22



FEATURES:

- Highly absorbent
- Quick to rinse
- To be used damp on all type of floors

CLOTHS & SPONGES / COMPOSTABLE

COMPOSTABLE CLOTH

CODE
PANN00075

DIMENSION
35x40 cm

PACK
20 pcs

UNIT PRICE
€ 0,61



Highly absorbent for daily use on any surface. Ideal for a slightly damp or dry use and biodegradable. It can be used also in the food sector.

RAINBOW

MULTI PURPOSE CLOTH
(80% VISCOSE - 20% MIXED FIBRES)

CODE
PANN00042

● 0005 ● 0002
● 0003 ● 0004

DIMENSION
35x40 cm

PACK
10 pcs

UNIT PRICE
€ 0,66



FEATURES:

- Scratch free
- High absorbency
- Ideal for all type of surfaces
- More volume for a better dirt removal

CLOTHS & SPONGES / WINDOW CLEANING

MICRO GLASS

MICROFIBRE GLASS CLOTH
(80% POLYESTER- 20% POLYAMIDE)

CODE
PANN00047

● 0015

DIMENSION
40x40 cm

PACK
5 pcs

UNIT PRICE
€ 2,95



FEATURES:

- Removes and retains dirt
- Streak free
- Ideal for mirror and windows
- Light and soft
- Long lasting

ECO RAINBOW

MULTI PURPOSE CLOTH
(85% VISCOSE - 15% POLYPROPYLENE)

CODE
PANN00039

● 0005 ● 0011
● 0003 ● 0004

DIMENSION
38x40 cm

PACK
10 pcs

UNIT PRICE
€ 0,31



FEATURES:

- Ideal for all type of surfaces
- Streak free cleaning
- Good absorbency
- Ideal for restroom cleaning

VETRIX

PERFORATED WINDOW CLOTH
(65% VISCOSE - 25% POLYESTER - 10% LATEX)

CODE
PANN00012

● 0004

DIMENSION
38x40 cm

PACK
10 pcs

UNIT PRICE
€ 2,15



FEATURES:

- Perforated window cloth
- Ideal for reflecting surfaces
- To be used with any chemicals
- Clean with no streaks
- Soft and supple for easy handling

SPECIFICATIONS

- **EXTREME ABSORBENCY**
- **BIODEGRADABLE**
- **100% NATURAL COTTON**

APPLICATION AREAS



SPONCOLOR

SPONGE WITH WHITE ABRASIVE SCOURER
(ANTI SCRATCH FIBRE: 100% POLYESTER –
SPONGE: 100% POLYURETHANE)

CODE
SPUG00016

- 0005 ● 0002
- 0003 ● 0004

DIMENSION
15x7x4,5 cm

PACK
10 pcs

UNIT PRICE
€ 0,82



FEATURES:

- Excellent dirt remove, no scratch
- Ideal for delicate surfaces
- Long lasting

MAGIC NANO SPONGE

SPONGE FOR DIRT, GRIME, STAINS, PENCIL
REMOVAL (HIGH DENSITY MELAMINE WITH
A POLYURETHANE INTERNAL LAYER)

CODE
PANN00055

- 0005 ● 0002
- 0003 ● 0004

DIMENSION
10x6,3x3 cm

PACK
1 pc

UNIT PRICE
€ 2,15

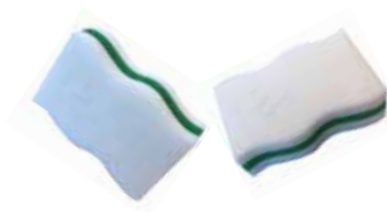

FEATURES:

- Long lasting
- Effective: remove stubborn stains instantly
- Suitable for: glass, leather, plastic, chromium plated, stainless steel
- Soft & flexible: thanks to polyurethane layer
- Hygienic

SPONBROWN

SPONGE WITH GREEN ABRASIVE SCOURER
(ANTI SCRATCH: 100% POLYESTER –
SPONGE: 100% POLYURETHANE)

CODE
SPUG00010

DIMENSION
14x9,5x3,5 cm

PACK
10 pcs

UNIT PRICE
€ 0,72



FEATURES:

- Perfect cleaning
- Good for all surfaces except delicate ones
- Long lasting

GISELLA

WET SPONGE CLOTH
(99% CELLULOSE – 1% NYLON)

CODE
SPUG00017

- 0005 ● 0011
- 0004

DIMENSION
18x20 cm

PACK
10 pcs

UNIT PRICE
€ 0,72

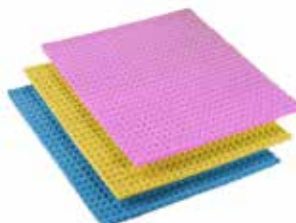

FEATURES:

- Good absorbency
- Easy to rinse, it dries quickly
- To be used with any chemicals

WASTE COLLECTION RANGE

LINEN

LINEN is a line of trolleys designed and built specifically for the collection of dirty linen which can be also used for waste collection.

LINEN is ideally suited in healthcare sector thanks to the Rilsan treated metal frame or in the hospitality industry and community.

The main characteristic is the modularity: each trolley, mounted on 4 rubber wheels Ø 80 mm. (nylon fork) and bumpers, is complete with a foot operated mechanism to open the lid for maximum hygiene and can be easily coupled to another equal with 2 screws, to form combinations suited to meet any collection need.

The cover, as the bag (capacity 70 lt., in plastic canvas or polyester for washing) resting on polypropylene plate for maximum stability, is available in different colors.



DETAILS

SUPPORT BAG 70 LT.
WITH FOOT OPERATOR LID



POLYPROPYLENE LID
AVAILABLE IN 4 COLORS



POLYPROPYLENE BASE
FOR BAG



FIBREGLASS AXIS
FOR LID OPENING



RUBBER WHEELS
(NYLON FORK) Ø 80 MM WITH BUMPERS



FIBREGLASS PEDAL
FOR LID



LINEN 21

SUPPORT BAG TROLLEY 1X70 LT.
1 BLUE LID
1 PEDAL

CODE
CARR00966

UNIT PRICE
€ 135,40



LINEN 22

SUPPORT BAG TROLLEY 2X70 LT.
2 BLUE, RED LIDS
2 PEDALS

CODE
CARR00971

UNIT PRICE
€ 274,70



LINEN 23

SUPPORT BAG TROLLEY 3X70 LT.
3 BLUE, RED, YELLOW LIDS
3 PEDALS

CODE
CARR00973

UNIT PRICE
€ 412,10



LINEN 24

SUPPORT BAG TROLLEY 4X70 LT.
4 BLUE, RED, YELLOW, GREEN LIDS
4 PEDALS

CODE
CARR00974

UNIT PRICE
€ 549,30



ACCESSORIES:

LINEN LID 70 LT

CODE
MPVR94555

- 0015
- 0002
- 0009
- 0004



UNIT PRICE
€ 18,00



Optional

70 LT. PLASTICIZED BAG WITH DRAWSTRING

CODE
SACC00021

- 0005
- 0002
- 0003
- 0004



UNIT PRICE
€ 38,40



COMPONENTS:

RILSAN FRAME WITHOUT WHEELS

CODE
COME00296

UNIT PRICE
€ 87,90



ELASTIC FOR WASTE BAG

CODE
MPVR94367

UNIT PRICE
€ 5,50



Optional

LINEN ASSEMBLY KIT

CODE
KTRI99670

UNIT PRICE
€ 1,20



POLYPROPYLENE BASE FOR BAG

CODE
MPVR94557 - 0006

UNIT PRICE
€ 7,15



NYLON PROTECTIVE BUMPER Ø 90 MM HOLE Ø 30 MM BLUE

CODE
MPVR94569 - 0015

UNIT PRICE
€ 1,22



RUBBER WHEEL (NYLON FORK) Ø 80 MM

CODE
RTRT00564 - 0606

UNIT PRICE
€ 6,50



FIBREGLASS BAR FOR PEDAL

CODE
MPVR94677 - 0006

UNIT PRICE
€ 5,50



FIBREGLASS PEDAL

CODE
MPVR94676 - 0006

UNIT PRICE
€ 5,80



RILSAN SUPPORT FOR PEDAL

CODE
LAFN99643

UNIT PRICE
€ 5,50



ETA / BETA







ETA/BETA is the waste collection line entirely made of polypropylene with aluminum center support for maximum strength and durability, practical even for outdoor use or in areas with high humidity.

With a 120 lt. polypropylene bag support completed with fixing bag, pushing/towing fiberglass handle, 45 mm. aluminum support, Ø 175 mm. rubber wheels (polypropylene fork) and feet, ETA is used as a fixed container for collection; BETA is completed with Ø 80 mm. wheels to be used as a traditional trolley.

They are available in gray, blue or white (FOOD line) for food industry related companies. Even the lid is available in different colors (blue, red, yellow, green, gray and white) for differentiated garbage collection.

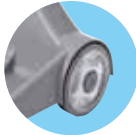
ETA/BETA is made with non-toxic, non-hazardous and **100% RECYCLABLE PLASTICS (POLYPROPYLENE, ALUMINUM, FIBERGLASS, NYLON)**. With this products, IPC is showing once again its commitment to the sustainability requirements and its commitment to follow the HACCP plans.

DETAILS

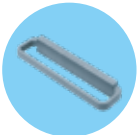
<p>120 LT. SUPPORT FOR BAG WITH FIXING BAG AND LID</p> 	<p>ALUMINUM CENTRAL SUPPORT</p> 	<p>Ø 175 MM WHEELS</p> 	<p>FOOT (ONLY FOR ETA 1)</p> 	<p>FOOT OPERATOR LID OPENING MECHANISM</p> 
<p>Ø 80 MM WHEELS (ONLY FOR BETA 1)</p> 	<p>FIBREGLASS PUSHING HANDLE</p> 			

ETA

DIMENSIONS
l x L x h
cm 50x50x94 h

WEIGH
8 kg

VOLUME
0,186 m³

ETA 1

POLYPROPYLENE WASTE TROLLEY
(WITH LID AND PEDAL)

CODE	DIGIT	UNIT PRICE
CARR00929	● 0606	€ 103,40
CARR00498	● 1515	€ 103,40
CARR00498	○ 0101	€ 103,40



BETA

DIMENSIONS
l x L x h
cm 51x50x94 h

WEIGH
7,8 kg

VOLUME
0,186 m³

BETA 1

POLYPROPYLENE WASTE TROLLEY
(WITH LID AND PEDAL)

CODE	DIGIT	UNIT PRICE
CARR00864	● 0606	€ 105,60
CARR00497	● 1515	€ 105,60
CARR00497	○ 0101	€ 105,60



COMPONENTS AND ACCESSORIES:

ETA/BETA LID 120 LT.

CODE
MPVR94671

- 0006 ○ 0001
● 0015



UNIT PRICE
€ 18,80

**120 LT. PLASTICIZED BAG
WITH FRONTAL OPENING**

CODE
SACC00034

- 0006

UNIT PRICE
€ 47,40



POLYPROPYLENE TRAY

CODE
MPVR94603

- 0006 ○ 0001
● 0015



UNIT PRICE
€ 7,35

**POLYPROPYLENE BASE
WITH 2 RUBBER WHEELS Ø 175 MM (POLYPROPYLENE
FORK) AND 2 POLYPROPYLENE FEETS**

CODE
PMVR95624

- 0006 ○ 0001
● 0015



UNIT PRICE
€ 40,70

**POLYPROPYLENE BASE
WITH 2 RUBBER WHEELS Ø 175 MM (POLYPROPYLENE
FORK) AND 2 RUBBER WHEELS Ø 80 MM**

CODE
PMVR95623

- 0006 ○ 0001
● 0015

UNIT PRICE
€ 42,75



**FIBREGLASS SUPPORT
FOR 120 LT BAG COMPLETE WITH CLIPS
HOLDING BAG**

CODE
PMVR95622

- 0006 ○ 0001
● 0015

UNIT PRICE
€ 21,95



**FIBREGLASS PUSHING
HANDLE**

CODE
MPVR94594

- 0006 ○ 0001
● 0015

UNIT PRICE
€ 7,45



45 CM ALUMINUM SUPPORT

CODE
PRAL00076

- 0006 ○ 0001
● 0015

UNIT PRICE
€ 11,60



**45 CM ALUMINUM SUPPORT
WITH CONNECTION FOR TRAY**

CODE
PRAL00033

- 0006 ○ 0001
● 0015

UNIT PRICE
€ 17,50



FIBREGLASS PEDAL

CODE
MPVR94676

- 0006 ○ 0001
● 0015

UNIT PRICE
€ 5,80



FIBREGLASS BAR FOR PEDAL

CODE
MPVR94677

- 0006 ○ 0001
● 0015

UNIT PRICE
€ 5,50



POLYPROPYLENE FOOT

CODE
MPVR94675

- 0006 ○ 0001
● 0015

UNIT PRICE
€ 2,45



**RUBBER WHEEL Ø 175 MM
(POLYPROPYLENE HUB)**

CODE
RTRT00563 - 0606

UNIT PRICE
€ 8,05



**RUBBER WHEEL Ø 80 MM
(NYLON FORK)**

CODE
RTRT00566

- 0006 ○ 0001
● 0015

UNIT PRICE
€ 6,50



"X" FRAMED PAINTED WASTE TROLLEY

(Ø 22 MM FRAME) - ROUND

CODE

CARR01098

DIMENSIONS

l x L x h

cm 56x62x103 h

WEIGHT

6,3 kg

VOLUME

0,252 m³

UNIT PRICE

€ 86,50



COMPOSITION	CODE	DIGIT	UNIT PRICE
Painted round bag support 120 lt.	PMLA96036		€ 19,90
Elastic bag holder	MPVR94367		€ 5,50
Ø 80 mm. wheel	RTRT00564	●0606	€ 6,50
Protective bumper	MPVR94571	●0015	€ 1,02

"X" FRAMED CHROMED WASTE TROLLEY

(Ø 22 MM FRAME) - ROUND

CODE

CARR01096

DIMENSIONS

l x L x h

cm 56x62x105 h

WEIGHT

6,3 kg

VOLUME

0,252 m³

UNIT PRICE

€ 101,30



COMPOSITION	CODE	DIGIT	UNIT PRICE
Chromed round bag support 120 lt.	PMLA96034		€ 20,90
Elastic bag holder	MPVR94367		€ 5,50
Ø 80 mm. wheel	RTRT00564	●0606	€ 6,50
Protective bumper	MPVR94571	●0015	€ 1,02

"X" FRAMED CHROMED WASTE TROLLEY

(Ø 22 MM FRAME) - SQUARE

CODE

CARR01095

DIMENSIONS

l x L x h

cm 56x62x103 h

WEIGHT

7,2 kg

VOLUME

0,252 m³

UNIT PRICE

€ 115,30



COMPOSITION	CODE	DIGIT	UNIT PRICE
Chromed square bag support 120 lt.	PMLA96035		€ 25,50
Clip for bag	MPVR94575	●0001	€ 0,72
Ø 80 mm. wheel	RTRT00564	●0606	€ 6,50
Protective bumper	MPVR94571	●0015	€ 1,02

ACCESSORIES:

POLYPROPYLENE ROUND LID

CODE

MPVR94556

●0015 ●0002 ●0009 ●0004

UNIT PRICE

€ 19,30



POLYPROPYLENE SQUARE LID

CODE

MPVR94551

●0015 ●0002

UNIT PRICE

€ 19,30



CHROMED SQUARE BAG SUPPORT

CODE
PMLA96035



UNIT PRICE
€ 25,10

EXPORT CLIP WITH SPRING FOR BAG

CODE
MPVR94368



UNIT PRICE
€ 1,32

PAINTED BASKET CM 41X23X19

CODE
PMLA95978



UNIT PRICE
€ 21,95

PAPER HOLDER FOR CHROMED X TROLLEY

CODE
POCA00001



UNIT PRICE
€ 47,20

HANDLE SUPPORT Ø 20 MM

CODE
PMVR95633 - 0015



UNIT PRICE
€ 5,00

CHROMED GRATE FOR DUST MOP

CODE
LAFN99688



UNIT PRICE
€ 8,85

RUBBER BAND HOLDING BAG

CODE
MPVR94367



UNIT PRICE
€ 5,40

BUMPER Ø 90 MM WITH HOLE Ø 22 MM

CODE
MPVR94571 - 0015



UNIT PRICE
€ 1,00

PVC 120 LT BLUE SQUARE BAG FOR X TROLLEY

CODE
SACC00046 - 0005



UNIT PRICE
€ 42,85

PAPER HOLDER FOR PAINTED X TROLLEY

CODE
POCA00004



UNIT PRICE
€ 45,20

HANDLE SUPPORT Ø 22 MM

CODE
MPVR99799 - 0005



UNIT PRICE
€ 5,00

CLIP FOR BAG

CODE
MPVR94575 - 0001

PACK
3



UNIT PRICE
€ 0,70

NYLON WHEEL Ø 80 MM 10X15 MM

CODE
RTRT00564 - 0606



UNIT PRICE
€ 6,40

PVC BAG FOR CLEANING TOOLS

CODE
PORT00002

● 0005



UNIT PRICE
€ 48,30

PLASTIC HANDLE HOLDER Ø 22 MM

CODE
PMVR95631 - 0015



UNIT PRICE
€ 5,00

FRAME WITH 4 HANDLE SUPPORT

CODE
COME00300



UNIT PRICE
€ 19,80

WASTE BAG CHROMED TROLLEY

WITH PEDAL

CODE
CARR00050

DIMENSIONS
l x L x h
cm 41x45x102,5 h

WEIGHT
7,5 Kg

UNIT PRICE
€ 167,00



COMPONENTS:

Ø 175 MM WHEEL

CODE
RTRT00563 - 0606



UNIT PRICE
€ 8,05

CHROMED SUPPORT WASTE BAG 120 LT. WITH 3 CLIPS FOR WASTE BAG

CODE
PMLA96014



UNIT PRICE
€ 23,65

SUPPORT FOR WASTE BAG HOLDER

CODE
PMLA96039



UNIT PRICE
€ 9,35

PEDAL KIT (2 POLES + PEDAL)

CODE
PMLA96030



UNIT PRICE
€ 31,00

ACCESSORIES:

POLYPROPYLENE SQUARE LID

CODE
MPVR94551

● 0015 ● 0002

UNIT PRICE
€ 19,30



BINNY
WITH PEDAL



STD
standard plastic



BLACK IS GREEN™
recycled plastic

CODE	DIGIT	VERSION	CAP.	UNITS	DIMENSIONS (l x L x h)	UNIT PRICE
CONT00021	0001	STD	25 l	4	320x250x495 mm	€ 22,95
	0015					
	0002					
	0009					
	0004					
CONT00022	0199	BLACK	50 l	4	400x310x630 mm	€ 31,90
	1599					
	0299					
	0999					
	0499					

BINNY
WITH SWING LID



STD
standard plastic



BLACK IS GREEN™
recycled plastic

CODE	DIGIT	VERSION	CAP.	UNITS	DIMENSIONS (l x L x h)	UNIT PRICE
CONT00011	0001	STD	15 l	4	290x225x460 mm	€ 16,45
	0015					
	0002					
	0009					
	0004					
CONT00012	0199	BLACK	25 l	4	320x250x505 mm	€ 18,70
	1599					
	0299					
	0999					
	0499					
CONT00013	0001	STD	50 l	4	400x310x640 mm	€ 29,15
	0015					
	0002					
	0009					
	0004					
CONT00014	0199	BLACK	50 l	4	400x310x640 mm	€ 27,90
	1599					
	0299					
	0999					
	0499					

ACCESSORIES:

HOOKING

FOR BINNY 25 LT.

FOR BINNY 50 LT.

CODE
MPVR94518

CODE
MPVR94519

DIGIT
0001

DIGIT
0001

UNIT PRICE
€ 4,10

UNIT PRICE
€ 4,70



POLYPROPYLENE DEODORANT HOLDER

CODE
MPVR94629 - 0006

UNIT PRICE
€ 1,12



BINNY 17



STD
standard plastic

CODE
CONT00020

DIGIT
● 0015

VERSION
STD

CAPACITY
17 l

UNITS
2

DIMENSIONS
(l x L x h)
mm 235x440x485 h

UNIT PRICE
€ 25,30

BINNY 17P



STD
standard plastic

CODE
CONT00024

DIGIT
● 0002

VERSION
STD

CAPACITY
17 l

UNITS
2

DIMENSIONS
(l x L x h)
mm 235x440x495 h

UNIT PRICE
€ 25,90

BINNY INOX WITH PEDAL



CODE	CAP	UNITS	DIMENSIONS (Ø x h)	UNIT PRICE
ACBA00050	3 l	1	Ø 170x265 h	€ 18,80
ACBA00051	5 l	1	Ø 205x285 h	€ 25,40
ACBA00052	12 l	1	Ø 250x400 h	€ 42,85

95 LT. DUSTBIN

CODE
CONT00023

○ 0001

CAPACITY
95 l

UNITS
2

DIMENSIONS
l x L x h
mm 555x410x880 h

UNIT PRICE
€ 93,40



120 LT. DUSTBIN

CODE WITH PEDAL
CONT00015

○ 0001 ● 0003

CAPACITY
120 l

UNITS
1

DIMENSIONS
l x L x h
mm 550x480x930 h

UNIT PRICE
€ 173,20



SMOKY

COLUMN, WITH KEY LOCK

CODE
CONT00004

MATERIAL
Stainless Steel

DIMENSIONS
Ø X h
mm 90x1010 h

COLOR
Satin

UNIT PRICE
€ 259,50



ROUND SMOKY

SEMICIRCULAR WALL-MOUNTED

CODE
CONT00005

MATERIAL
Stainless Steel

DIMENSIONS
Ø X h
mm 200x140 h

COLOR
Polished

UNIT PRICE
€ 50,65



SMOKY PLUS

BIN AND SELF EXTINGUISHING ASHTRAY

CODE
CONT00006

MATERIAL
Stainless Steel

DIMENSIONS
Ø X h
mm 250x800 h

COLOR
Polished/Satin

UNIT PRICE
€ 197,10



CLEANING TROLLEYS RANGE

MODULARITY SOLUTIONS FOR ALL NEEDS

Brix trolleys range is the ideal solution for all cleaning applications.

Black is Green trolleys combine the advantages of Brix modularity with the environmental benefits of recycled plastic.



KINETIC WRINGER

Kinetic is the wringer of the future, where technology meets design for an improved operator experience. In fact, with this single tool, Kinetic delivers the best performance and maximum well-being for the operator.



MCS
MULTIFUNCTION
CONTROL
SYSTEM

NEW MULTIFUNCTION CONTROL SYSTEM.

The innovative patent pending Multifunction Control System allows the operator to select the right level of mop wringing, according to the surface and type of washing required, maximising the water used.



HIGH



MEDIUM



LOW



EDT
ERGONOMIC
DESIGN
TOOL

DESIGNED AROUND THE USER.

The ergonomic handle with its 360° free rotation system and working angle, allows the operator to keep their correct posture and work with less effort.

For the version with Kinetic Plus wringer of all the trolleys in the catalogue (except Brix trolleys) it will be to put the number "5" as a fifth position in the code (after CARR or SECC). Example: CARR00038 with Kinetic Plus wringer will become CARR50038

CLEANING TROLLEYS RANGE /

**MINI
WASHING
TROLLEYS
RANGE**

TROLLEYS WITH WRINGER

PUSHING HANDLE

WRINGER

(vertical with jaws, side press or roller type) inserted into the red bucket

GREY BUCKET

for the cleaning solution

RED BUCKET

for the dirty recovery water

FRAME

with wheels and bumpers



USING THE DOUBLE BUCKET FEATURES

avoids the dirty mop/fringe to be wringed into the clean solution bucket.

A variant of this trolley is the **SINGLE BUCKET** on wheels trolley. As the word, the single bucket on wheels is simply a bucket (of consistent thickness) on which the wheels are screwed directly on and where to put the wringer, without chassis.

Recently, the single bucket on wheels trolley has **EVOLVED INTO A DOUBLE SECTION** for an effective separation of dirty water from clean one and often well equipped with a drain plug in order to easily empty the dirty water.

THE FREQUENCY OF THE CHANGE DEPENDS ON THE FLOOR SOILING.

METHOD OF USE

PHASE 1

Fill the grey bucket with water up to 2/3, fill the red bucket with water up to 1/3; pour into the blue bucket the correct dose as recommended on the chemical label.

PHASE 2

Soak the mop into the blue bucket to absorb the solution.

PHASE 3

Introduce mop in the wringer and slightly wring it.

PHASE 4

Proceed with the cleaning operation on the floor with the mop, making sure it adheres well to the surface, walking backwards with "S" shape movements.

PHASE 5

Soak the mop into the red bucket, to dilute the accumulated dirt.

PHASE 6

Wring the mop to eliminate as much as possible water and dirt, which will be deposited in the red bucket.

PHASE 7

Dip the mop into the blue bucket to absorb a sufficient amount of solution and repeat cleaning operations, starting from **STEP 4**.

SINGLE BUCKET 18 LT. SPEED/BOOK

CODE
SECC00033

● 0015 ● 0002
● 0009 ● 0004

SIZE:
mm 350x600x750 h

WEIGHT:
Kg 4,3

VOLUME:
0,063 m³

PACKAGING DIMENSIONS:
mm 450x355x395 h

UNIT PRICE
€ 95,50



COMPOSITION	CODE	DIGIT	UNIT PRICE
18 LT. BUCKET ON WHEELS WITH 4 CASTORS Ø 80 MM (RTRT00566)	SECC00061	● 0015	€ 47,40
		● 0002	
		● 0009	
		● 0004	
SPEED/BOOK WRINGER	STRI00003	● 0015	€ 49,50
		● 0002	
		● 0009	
		● 0004	

SINGLE BUCKET 18 LT. NEW LINE/STRONG

CODE
SECC00034

● IP15 ● IP02
● IP09 ● IP04

SIZE:
mm 350x500x760 h

WEIGHT:
Kg 4,7

VOLUME:
0,093 m³

PACKAGING DIMENSIONS:
mm 475x440x445 h

UNIT PRICE
€ 100,80



COMPOSITION	CODE	DIGIT	UNIT PRICE
18 LT. BUCKET ON WHEELS WITH 4 CASTORS Ø 80 MM (RTRT00566)	SECC00061	● 0015	€ 47,40
		● 0002	
		● 0009	
		● 0004	
NEW LINE/STRONG WRINGER	STRI00030	● IP15	€ 54,90
		● IP02	
		● IP09	
		● IP04	

SINGLE BUCKET 25 LT. NEW LINE/STRONG

CODE
SECC00027

● IP15 ● IP02
● IP09 ● IP04

SIZE:
mm 430x500x780 h

WEIGHT:
Kg 5,75

VOLUME:
0,093 m³

PACKAGING DIMENSIONS:
mm 475x440x445 h

UNIT PRICE
€ 110,40



COMPOSITION	CODE	DIGIT	UNIT PRICE
25 LT. BUCKET ON WHEELS WITH 4 CASTORS Ø 80 MM (RTRT00566) WITH BUMPER	SECC00032	● 0015	€ 58,20
		● 0002	
		● 0009	
		● 0004	
NEW LINE/STRONG WRINGER	STRI00030	● IP15	€ 54,90
		● IP02	
		● IP09	
		● IP04	

OPTIONAL	CODE	DIGIT	UNIT PRICE
RILSAN PUSHING HANDLE	PMLA96026		€ 21,95
RILSAN BASKET	PMLA96003		€ 26,40
DIRT SCREEN FOR 25 LT. BUCKET ON WHEELS	MPVR94361	0006	€ 7,25

ERGONOMIC BUCKET ON WHEELS 25 LT.

CODE
SECC00035

- IP15 ● IP02
- IP09 ● IP04

SIZE:
mm 380x520x960 h

WEIGHT:
Kg 5,35

VOLUME:
0,093 m³

PACKAGING DIMENSIONS:
mm 475x440x445 h

UNIT PRICE
€ 112,10



COMPOSITION	CODE	DIGIT	UNIT PRICE
25 LT. BUCKET WITH 4 WHEELS Ø 80 MM (RTRT00566), 4 BUMPERS Ø 90 MM WITH HOLE Ø 30 MM AND 2 FEET SUPPORT CASTORS	SECC00001	<ul style="list-style-type: none"> ● 0015 ● 0002 ● 0009 ● 0004 	€ 57,15
NEW LINE/STRONG WRINGER	STRI00030	<ul style="list-style-type: none"> ● IP15 ● IP02 ● IP09 ● IP04 	€ 54,90
OPTIONAL			
DIRT SCREEN FOR 25 LT. ERGONOMIC BUCKET ON WHEELS	MPVR94360		€ 5,50

DOUBLE BUCKET ON WHEELS 12+18 LT.

CODE
SECC00037

- IP15 ● IP02
- IP09 ● IP04

SIZE:
mm 360x600x820 h

WEIGHT:
Kg 5,35

VOLUME:
0,115 m³

PACKAGING DIMENSIONS:
mm 485x430x550 h

UNIT PRICE
€ 104,40



COMPOSITION	CODE	DIGIT	UNIT PRICE
12+18 LT. BUCKET WITH 4 WHEELS Ø 80 MM (RTRT00566), 4 BUMPERS Ø 90 MM WITH HOLE Ø 30 MM	SECC00003	<ul style="list-style-type: none"> ● 0015 ● 0002 ● 0009 ● 0004 	€ 49,60
SUPPORT FOR MOP WRINGER	MPVR94664	● 0006	€ 6,80
NEW LINE/STRONG WRINGER	STRI00030	<ul style="list-style-type: none"> ● IP15 ● IP02 ● IP09 ● IP04 	€ 54,90

ECOMIX BUCKET ON WHEELS 25 LT.

CODE
SECC00142

- IP15 ● IP02
- IP09 ● IP04

SIZE:
mm 540x370x810 h

WEIGHT:
Kg 4,5

VOLUME:
0,085 m³

PACKAGING DIMENSIONS:
mm 420x385x525 h

UNIT PRICE
€ 95,00



ECOMIX BUCKET ON WHEELS 25 LT. WITH DRAIN PLUG

CODE
CARR01307 ● IP15 ● IP02 ● IP09 ● IP04

UNIT PRICE
€ 106,20

COMPOSITION	CODE	DIGIT	UNIT PRICE
25 LT. BUCKET WITH 4 WHEELS Ø 80MM (RTRT00566), 4 BUMPERS AND DRAIN PLUG	CARR00984	<ul style="list-style-type: none"> ● 0015 ● 0002 ● 0009 ● 0004 	€ 51,30
25 LT. BUCKET WITH 4 WHEELS Ø 80MM (RTRT00566) AND 4 BUMPERS	SECC00008	<ul style="list-style-type: none"> ● 0015 ● 0002 ● 0009 ● 0004 	€ 40,20
NEW LINE/STRONG WRINGER	STRI00030	<ul style="list-style-type: none"> ● IP15 ● IP02 ● IP09 ● IP04 	€ 54,90

DOUBLE BUCKET ON WHEELS 12+18 LT. WITH DRAIN PLUG

CODE
SECC00040

- IP15 ● IP02
- IP09 ● IP04

SIZE:
mm 360x600x820 h

WEIGHT:
Kg 5,35

VOLUME:
0,115 m³

PACKAGING DIMENSIONS:
mm 485x430x550 h

UNIT PRICE
€ 114,00



COMPOSITION	CODE	DIGIT	UNIT PRICE
12+18 LT. BUCKET WITH 4 WHEELS Ø 80 MM (RTRT00566), 4 BUMPERS Ø 90 MM WITH HOLE Ø 30 MM AND WRINGER SUPPORT	SECC00007	<ul style="list-style-type: none"> ● 0015 ● 0002 ● 0009 ● 0004 	€ 59,10
SUPPORT FOR MOP WRINGER	MPVR94664	● 0006	€ 6,80
NEW LINE/STRONG WRINGER	STRI00030	<ul style="list-style-type: none"> ● IP15 ● IP02 ● IP09 ● IP04 	€ 54,90



Equipped with **DRAIN PLUG** for a quick emptying

DOLLY-CLEVVY BUCKET

WITH WRINGER
SPEED / BOOK

CODE
SECC00044

● 0015 ● 0002
● 0009 ● 0004

SIZE:
mm 540x280x420 h

WEIGHT:
Kg 3,5

VOLUME:
0,081 m³

PACKAGING DIMENSIONS:
mm 560x330x440 h

UNIT PRICE
€ 78,70



BUCKET WITH DOUBLE SECTIONS,
incorporated mop wringer Speed/Book,
4 castors ø 50 mm, double carrying handle,
drain plug and shim

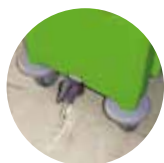

Equipped with
DRAIN PLUG
for a quick emptying

DOLLY-CLEVVY KIT PACK

CODE
SECC00046

● 0015 ● 0002
● 0009 ● 0004

SIZE:
mm 540x290x700 h

WIGHT:
Kg 4,8

VOLUME:
0,073 m³

PACKAGING DIMENSIONS:
mm 557x297x445 h

UNIT PRICE
€ 99,10



BUCKET WITH DOUBLE SECTIONS,
mop wringer new line / strong,
4 castors ø 50 mm,
double carrying handle and shim

ECO-SPEED FRAME
CHROMED HANDLE
MICROFIBRE REPLACEMENT



Equipped with
DRAIN PLUG
for a quick emptying

DOLLY-CLEVVY ACCESSORIES

BOTTOM GRID
FOR DOLLY/CLEVVY WRINGER

CODE
MPVR94359 - 0006



UNIT PRICE
€ 3,60

MOUSSE SHIM
FOR DOLLY/CLEVVY WRINGER

CODE
LAMU00003



UNIT PRICE
€ 9,75

DOLLY-CLEVVY BUCKET

WITH WRINGER
NEW LINE / STRONG

CODE
SECC00009

● IP15 ● IP02
● IP09 ● IP04

SIZE:
mm 540x280x640 h

WEIGHT:
Kg 5

VOLUME:
0,101 m³

PACKAGING DIMENSIONS:
mm 560x300x600 h

UNIT PRICE
€ 84,55



BUCKET WITH DOUBLE SECTIONS,
incorporated mop wringer newline / strong,
4 castors ø 50 mm and double carrying handle

CLEANING TROLLEYS RANGE /

CHROMED

&

SMALL

TROLLEYS

RANGE

CHROMED TROLLEY - 50 LT.
WITH Ø 80 MM PLASTIC WHEELS

CODE
CARR00006

UNIT PRICE
€ 149,70

SIZE:
mm 780 x 410 x 780 h

WEIGHT:
Kg 9

VOLUME:
0,190 m³

PACKAGING DIMENSIONS:
mm 790 x 440 x 540 h

CHROMED TROLLEY - 30 LT.
WITH Ø 80 MM PLASTIC WHEELS

CODE
CARR00015

UNIT PRICE
€ 149,70

SIZE:
mm 750 x 410 x 830 h

WEIGHT:
Kg 9,10

VOLUME:
0,184 m³

PACKAGING DIMENSIONS:
mm 790 x 440 x 540 h

CHROMED TROLLEY - 50 LT.
WITH Ø 80 MM PLASTIC WHEELS AND MOUSSE SHIM

CODE
CARR02177

UNIT PRICE
€ 154,30

SIZE:
mm 780 x 410 x 890 h

PESO:
Kg 9,10

WEIGHT:
0,184 m³

PACKAGING DIMENSIONS:
mm 790 x 440 x 530 h

CHROMED TROLLEY - 30 LT.
WITH Ø 80 MM PLASTIC WHEELS AND MOUSSE SHIM

CODE
CARR01353

UNIT PRICE
€ 154,30

SIZE:
mm 750 x 410 x 830 h

PESO:
Kg 9,10

WEIGHT:
0,190 m³

PACKAGING DIMENSIONS:
mm 790 x 445 x 540 h

CHROMED TROLLEY - 50 LT.
WITH Ø 80 MM METAL WHEELS

CODE
CARR01725

UNIT PRICE
€ 146,50

SIZE:
mm 780 x 410 x 890 h

WEIGHT:
Kg 9,30

VOLUME:
0,184 m³

PACKAGING DIMENSIONS:
mm 790 x 440 x 530 h

CHROMED TROLLEY - 30 LT.
WITH Ø 80 MM METAL WHEELS

CODE
CARR01802

UNIT PRICE
€ 146,50

SIZE:
mm 750 x 410 x 830 h

WEIGHT:
Kg 9,30

VOLUME:
0,190 m³

PACKAGING DIMENSIONS:
mm 790 x 445 x 540 h



CHROMED TROLLEY - 25 LT.
WITH Ø 80 MM PLASTIC WHEELS

CODE
CARR00021

UNIT PRICE
€ 129,20

SIZE:
mm 480 x 410 x 880 h

WEIGHT:
Kg 6,35

VOLUME:
0,115 m³

PACKAGING DIMENSIONS:
mm 485 x 430 x 550 h



CHROMED TROLLEY - 15 LT.
WITH Ø 80 MM PLASTIC WHEELS

CODE
CARR00024

UNIT PRICE
€ 129,20

SIZE:
mm 470 x 410 x 820 h

WEIGHT:
Kg 6,35

VOLUME:
0,115 m³

PACKAGING DIMENSIONS:
mm 485 x 430 x 550 h



CHROMED TROLLEY - 25 LT.
WITH Ø 80 MM METAL WHEELS

CODE
CARR01816

UNIT PRICE
€ 133,20

SIZE:
mm 480 x 410 x 880 h

WEIGHT:
Kg 6,35

VOLUME:
0,115 m³

PACKAGING DIMENSIONS:
mm 485 x 430 x 550 h



CHROMED TROLLEY - 15 LT.
WITH Ø 80 MM METAL WHEELS

CODE
CARR01817

UNIT PRICE
€ 133,20

SIZE:
mm 470 x 410 x 820 h

WEIGHT:
Kg 6,35

VOLUME:
0,115 m³

PACKAGING DIMENSIONS:
mm 485 x 430 x 550 h



**CHROMED TROLLEY
ESAL - 50 LT.
WITH REVERSIBLE WRINGER**

CODE
CARR00013

UNIT PRICE
€ 213,30

SIZE:
mm 910 x 410 x 960 h

WEIGHT:
Kg 10,40

VOLUME:
0,181 m³

PACKAGING DIMENSIONS:
mm 790 x 445 x 540 h

**CHROMED TROLLEY
ESAL - 30 LT.
WITH REVERSIBLE WRINGER**

CODE
CARR00016

UNIT PRICE
€ 213,30

SIZE:
mm 870 x 410 x 930 h

WEIGHT:
Kg 10,30

VOLUME:
0,190 m³

PACKAGING DIMENSIONS:
mm 790 x 445 x 540 h



**CHROMED TROLLEY
EXPORT - 25 LT.
WITH BASKET**

CODE
CARR00020

UNIT PRICE
€ 161,60

SIZE:
mm 690 x 380 x 930 h

WEIGHT:
Kg 8

VOLUME:
0,152 m³

PACKAGING DIMENSIONS:
mm 715 x 395 x 540 h

**CHROMED TROLLEY
EXPORT - 15 LT.
WITH BASKET**

CODE
CARR00023

UNIT PRICE
€ 161,60

SIZE:
mm 600 x 380 x 930 h

WEIGHT:
Kg 8,10

VOLUME:
0,152 m³

PACKAGING DIMENSIONS:
mm 715 x 395 x 540 h



CHROMED TROLLEY UNIVERSAL MINI 1004-991 - 30 LT.

CODE
CARR00052

UNIT PRICE
€ 339,30

SIZE:
mm 810 x 675 x 1190 h

WEIGHT:
Kg 17,80

VOLUME:
0,302 m³

PACKAGING DIMENSIONS:
mm 860 x 670 x 525 h



Lid and bag are optional

CHROMED TROLLEY UNIVERSAL MAXI 991 - 30 LT.

CODE
CARR00058

UNIT PRICE
€ 484,80

SIZE:
mm 1110 x 675 x 1120 h

WEIGHT:
Kg 26,30

VOLUME:
0,302 m³

PACKAGING DIMENSIONS:
mm 860 x 670 x 525 h



Lid and bag are optional

CHROMED TROLLEY UNIVERSAL MAXI 1007-991 - 120 LT.

CODE
CARR00056

UNIT PRICE
€ 441,60

SIZE:
mm 1210 x 700 x 1070 h

WEIGHT:
Kg 22,60

VOLUME:
0,302 m³

PACKAGING DIMENSIONS:
mm 860 x 670 x 525 h



Lid and bag are optional

ACCESSORIES:

UNIVERSAL LID SQUARE 120 LT.

CODE
MPVR94552

DIGIT
● 0002 ● 0015 ● 0003 ● 0004

UNIT PRICE
€ 22,95

ERGONOMIC CHROMED TROLLEY TOGO 1 - 30 LT.

CODE
CARR00045

UNIT PRICE
€ 312,30

SIZE:
mm 770 x 655 x 1020 h

WEIGHT:
Kg 16,80

VOLUME:
0,190 m³

PACKAGING DIMENSIONS:
mm 790 x 445 x 540 h



Lid and bag are optionals

ACCESSORIES:

120 LT. LID

CODE
MPVR94552

DIGIT
● 0006

UNIT PRICE
€ 22,95

CHROMED TROLLEY TOGO - 15 LT.

CODE
CARR00038

UNIT PRICE
€ 301,60

SIZE:
mm 850 x 490 x 1070 h

WEIGHT:
Kg 16,30

VOLUME:
0,190 m³

PACKAGING DIMENSIONS:
mm 790 x 445 x 540 h



Lid and bag are optionals

120 LT. BAG

CODE
SACC00034

DIGIT
● 0006

UNIT PRICE
€ 47,40

CHROMED TROLLEY TOGO 2 FULL - 30 LT.

CODE
CARR00041

UNIT PRICE
€ 361,30

SIZE:
mm 950 x 670 x 1220 h

WEIGHT:
Kg 19,20

VOLUME:
0,302 m³

PACKAGING DIMENSIONS:
mm 860 x 670 x 525 h



Lid and bag are optionals

ACCESSORIES:

70 LT. LID

CODE
MPVR94554

DIGIT
● 0002 ● 0005

UNIT PRICE
€ 18,00

70 LT. BAG

CODE
SACC00021

DIGIT
● 0002 ● 0005 ● 0003 ● 0004

UNIT PRICE
€ 38,40

**CHROMED TROLLEY
MILLEUSI - E1001**
COMPLETE WITH BASKETS & BUCKETS

CODE
CARR00036

UNIT PRICE
€ 215,50

SIZE:
mm 810 x 500 x 1120 h

WEIGHT:
Kg 10,20

VOLUME:
0,178 m³

PACKAGING DIMENSIONS:
mm 940 x 620 x 305 h



Lid, frame and bag are optional

ACCESSORIES:

120 LT. LID

CODE
MPVR94551

DIGIT
● 0002 ● 0005

UNIT PRICE
€ 19,30

**120 LT. LID
WITH FRONT OPENING**

CODE
SACC00034

DIGIT
● 0006

UNIT PRICE
€ 47,40

**CHROMED TROLLEY
MILLEUSI - E1006**
COMPLETE WITH BASKETS & BUCKETS

CODE
CARR00048

UNIT PRICE
€ 269,30

SIZE:
mm 670 x 590 x 1050 h

WEIGHT:
Kg 13,30

VOLUME:
0,178 m³

PACKAGING DIMENSIONS:
mm 940 x 620 x 305 h



Lid, frame and bag are optional

ACCESSORIES:

120 LT. LID

CODE
MPVR94552

DIGIT
● 0002 ● 0003 ● 0004 ● 0015

UNIT PRICE
€ 22,95

**TRIS2P - 2X25 LT.
WITH LATERAL PUSHING HANDLE**

With **NEW LINE** wringer
CODE Assembled
CARR00511

UNIT PRICE
€ 126,30

CODICE Disassemblato
CARR00509

UNIT PRICE
€ 125,30

With **KINETIC** wringer
CODE Assembled
CARR50511

UNIT PRICE
€ 141,40

CODE Disassembled
CARR50509

UNIT PRICE
€ 140,40

SIZE:
mm 750x435x930 h

WEIGHT:
Kg 8,55

VOLUME:
0,175 m³

PACKAGING DIMENSIONS:
mm 740x450x525 h



**TRIS2P - 2X15 LT.
WITH LATERAL PUSHING HANDLE**

With **NEW LINE** wringer
CODE Assembled
CARR00510

PREZZO UNITARIO
€ 126,30

CODE Disassembled
CARR00508

UNIT PRICE
€ 125,30

With **KINETIC** wringer
CODE Assembled
CARR50510

UNIT PRICE
€ 141,40

CODE Disassembled
CARR50508

UNIT PRICE
€ 140,40

- IP15 ● IP10
- IP09 ● IP04

SIZE:
mm 750x435x930 h

WEIGHT:
Kg 8,75

VOLUME:
0,175 m³

PACKAGING DIMENSIONS:
mm 740x450x525 h



COMPOSITION	CODE	DIGIT	UNIT PRICE
BASE WITH 4 WHEELS Ø 80 MM, 4 BUMPERS Ø 90 MM AND 1 TOP FOR DOVETAIL JOINT	PMVR95608	● 0015	€ 41,80
		● 0010	
		● 0009	
		● 0004	
25 LT. PLASTIC BUCKET	SECC00057	● 0620 ● 0618	€ 13,90
VARNISHED LATERAL PUSHING HANDLE "PLUS" WITH 2 LINKING PINS, GREY	PMLA96087	-	€ 13,80
NEW LINE/ STRONG WRINGER	STRI00030	● IP15	€ 54,90
		● IP02	
		● IP09	
		● IP04	
KINETIC WRINGER	STRI00072	● IP09	€ 70,00

OPTIONAL	CODE	DIGIT	UNIT PRICE
POLYPROPYLENE TRAY FOR LATERAL PUSHING HANDLE	MPVR94619	● 0006	€ 7,45

COMPOSITION	CODE	DIGIT	UNIT PRICE
BASE WITH 4 WHEELS Ø 80 MM, 4 BUMPERS Ø 90 MM AND 1 TOP FOR DOVETAIL JOINT	PMVR95608	● 0015	€ 41,80
		● 0010	
		● 0009	
		● 0004	
15 LT. PLASTIC BUCKET	SECC00055	● 0620 ● 0618	€ 13,90
VARNISHED LATERAL PUSHING HANDLE "PLUS" WITH 2 LINKING PINS, GREY	PMLA96087	-	€ 13,80
NEW LINE/ STRONG WRINGER	STRI00030	● IP15	€ 54,90
		● IP02	
		● IP09	
		● IP04	
KINETIC WRINGER	STRI00072	● IP09	€ 70,00

OPTIONAL	CODE	DIGIT	UNIT PRICE
POLYPROPYLENE TRAY FOR LATERAL PUSHING HANDLE	MPVR94619	● 0006	€ 7,45

All trolleys are available also with **ROLLER / RULLY** and **SPEED / BOOK** wringers (see page 194).
For trolleys without wringer deduct € 25,00 from the price list

TRIS3P - 25 LT. WITH LATERAL PUSHING HANDLE

With **NEW LINE** wringer
CODE
CARR00507

UNIT PRICE
€ 121,40

With **KINETIC** wringer
CODE
CARR50507

UNIT PRICE
€ 136,50

- IP15
- IP10
- IP09
- IP04

SIZE:
mm 535x435x930 h

WEIGHT:
Kg 7,5

VOLUME:
0,175 m³

PACKAGING DIMENSIONS:
mm 740x450x525 h



TRIS3P - 15 LT. WITH LATERAL PUSHING HANDLE

With **NEW LINE** wringer
CODE
CARR00506

UNIT PRICE
€ 121,40

With **KINETIC** wringer
CODE
CARR50506

UNIT PRICE
€ 136,50

- IP15
- IP10
- IP09
- IP04

SIZE:
mm 510x435x930 h

WEIGHT:
Kg 7,6

VOLUME:
0,175 m³

PACKAGING DIMENSIONS:
mm 740x450x525 h



COMPOSITION	CODE	DIGIT	UNIT PRICE
BASE WITH 4 WHEELS Ø 80 MM, 4 BUMPERS Ø 90 MM WITH HOLE Ø 30 MM AND 1 TOP FOR DOVETAIL JOINT	PMVR95607	<ul style="list-style-type: none"> ● 0015 ● 0010 ● 0009 ● 0004 	€ 38,40
TRAY MM 365X90X180 H	MPVR94646	<ul style="list-style-type: none"> ● 0015 ● 0010 ● 0009 ● 0004 	€ 4,70
25 LT. PLASTIC BUCKET	SECC00057	● 0618	€ 13,90
VARNISHED LATERAL PUSHING HANDLE "PLUS" WITH 2 LINKING PINS, GREY	PMLA96087	-	€ 13,80
NEW LINE/STRONG WRINGER	STRI00030	<ul style="list-style-type: none"> ● IP15 ● IP02 ● IP09 ● IP04 	€ 54,90
KINETIC WRINGER	STRI00072	● IP09	€ 70,00

OPTIONAL	CODE	DIGIT	UNIT PRICE
POLYPROPYLENE TRAY FOR LATERAL PUSHING HANDLE	MPVR94619	● 0006	€ 7,45

COMPOSITION	CODE	DIGIT	UNIT PRICE
BASE WITH 4 WHEELS Ø 80 MM, 4 BUMPERS Ø 90 MM WITH HOLE Ø 30 MM AND 1 TOP FOR DOVETAIL JOINT	PMVR95607	<ul style="list-style-type: none"> ● 0015 ● 0010 ● 0009 ● 0004 	€ 38,40
TRAY MM 365X90X180 H	MPVR94646	<ul style="list-style-type: none"> ● 0015 ● 0010 ● 0009 ● 0004 	€ 4,70
15 LT. PLASTIC BUCKET	SECC00055	● 0618	€ 13,90
VARNISHED LATERAL PUSHING HANDLE "PLUS" WITH 2 LINKING PINS, GREY	PMLA96087	-	€ 13,80
NEW LINE/STRONG WRINGER	STRI00030	<ul style="list-style-type: none"> ● IP15 ● IP02 ● IP09 ● IP04 	€ 54,90
KINETIC WRINGER	STRI00072	● IP09	€ 70,00

OPTIONAL	CODE	DIGIT	UNIT PRICE
POLYPROPYLENE TRAY FOR LATERAL PUSHING HANDLE	MPVR94619	● 0006	€ 7,45

All trolleys are available also with **ROLLER / RULLY and SPEED / BOOK** wringers (see page 194).

For trolleys without wringer deduct € 25,00 from the price list

TRIS3P - 25 LT.
WITH REVERSIBLE HANDLE AND TRAY

With **NEW LINE** wringer
CODE
CARR01930

With **KINETIC** wringer
CODE
CARR51930

UNIT PRICE
€ 137,90

UNIT PRICE
€ 153,00

- IP15 ● IP10
- IP09 ● IP04

SIZE:
mm 795x845x440 h

WEIGHT:
Kg 9,6

VOLUME:
0,297 m³

PACKAGING DIMENSIONS:
mm 743x453x518 h



TRIS3P - 15 LT.
WITH REVERSIBLE HANDLE AND TRAY

With **NEW LINE** wringer
CODE
CARR01774

With **KINETIC** wringer
CODE
CARR51774

UNIT PRICE
€ 137,90

UNIT PRICE
€ 153,00

- IP15 ● IP10
- IP09 ● IP04

SIZE:
mm 770x845x440 h

WEIGHT:
Kg 9,6

VOLUME:
0,286 m³

PACKAGING DIMENSIONS:
mm 743x453x518 h



COMPOSITION	CODE	DIGIT	UNIT PRICE
BASE WITH 4 WHEELS Ø 80 MM, 4 BUMPERS Ø 90 MM AND 1 TOP FOR DOVETAIL JOINT	PMVR95608	● 0015 ● 0010 ● 0009 ● 0004	€ 41,80
25 LT. PLASTIC BUCKET	SECC00057	● 0618	€ 13,90
VARNISHED REVERSIBLE HANDLE WITH 2 LINKING PINS	PMLA96088	-	€ 15,45
HANDLE TRAY	PMVR95609	● 0015 ● 0010 ● 0009 ● 0004	€ 8,75
HANDLE HOLDER	MPVR94778	● 0006	€ 3,35
NEW LINE/STRONG WRINGER	STRI00030	● IP15 ● IP02 ● IP09 ● IP04	€ 54,90
KINETIC WRINGER	STRI00072	● IP09	€ 70,00

COMPOSITION	CODE	DIGIT	UNIT PRICE
BASE WITH 4 WHEELS Ø 80 MM, 4 BUMPERS Ø 90 MM AND 1 TOP FOR DOVETAIL JOINT	PMVR95608	● 0015 ● 0010 ● 0009 ● 0004	€ 41,80
15 LT. PLASTIC BUCKET	SECC00055	● 0618	€ 13,90
VARNISHED REVERSIBLE HANDLE WITH 2 LINKING PINS	PMLA96088	-	€ 15,45
HANDLE TRAY	PMVR95609	● 0015 ● 0010 ● 0009 ● 0004	€ 8,75
HANDLE HOLDER	MPVR94778	● 0006	€ 3,35
NEW LINE/STRONG WRINGER	STRI00030	● IP15 ● IP02 ● IP09 ● IP04	€ 54,90
KINETIC WRINGER	STRI00072	● IP09	€ 70,00

All trolleys are available also with **ROLLER / RULLY** and **SPEED / BOOK** wringers (see page 194).
For trolleys without wringer deduct € 25,00 from the price list

**TRIS2P - 2X25 LT.
WITH REVERSIBLE HANDLE**

With **NEW LINE** wringer

CODE Assembled
CARR00434

UNIT PRICE
€ 127,50

CODE Disassembled
CARR00426

UNIT PRICE
€ 126,30

With **KINETIC** wringer

CODE Assembled
CARR50434

UNIT PRICE
€ 142,60

CODE Disassembled
CARR50426

UNIT PRICE
€ 141,40

- IP15
- IP10
- IP09
- IP04

SIZE:
mm 810x435x880 h

WEIGHT:
Kg 9,20

VOLUME:
0,175 m³

PACKAGING DIMENSIONS:
mm 740x450x525 h



COMPOSITION	CODE	DIGIT	UNIT PRICE
BASE WITH 4 WHEELS Ø 80 MM, 4 BUMPERS Ø 90 MM AND 1 TOP FOR DOVETAIL JOINT	PMVR95608	<ul style="list-style-type: none"> ● 0015 ● 0010 ● 0009 ● 0004 	€ 41,80
25 LT. PLASTIC BUCKET	SECC00057	<ul style="list-style-type: none"> ● 0620 ● 0618 	€ 13,90
VARNISHED REVERSIBLE HANDLE WITH 2 LINKING PINS	PMLA96088	-	€ 15,45
NEW LINE/STRONG WRINGER	STRI00030	<ul style="list-style-type: none"> ● IP15 ● IP02 ● IP09 ● IP04 	€ 54,90
KINETIC WRINGER	STRI00072	● IP09	€ 70,00

OPTIONAL	CODE	DIGIT	UNIT PRICE
VASCHETTA IN POLIPROPILENE PER MANIGLIA REVERSIBILE	PMVR95609	<ul style="list-style-type: none"> ● 0015 ● 0010 ● 0009 ● 0004 	€ 8,75

**TRIS2P - 2X15 LT.
WITH REVERSIBLE HANDLE**

With **NEW LINE** wringer

CODE Assembled
CARR00430

UNIT PRICE
€ 127,50

CODE Disassembled
CARR00425

UNIT PRICE
€ 126,30

With **KINETIC** wringer

CODE Assembled
CARR50430

UNIT PRICE
€ 142,60

CODE Disassembled
CARR50425

UNIT PRICE
€ 141,40

- IP15
- IP10
- IP09
- IP04

SIZE:
mm 780x435x880 h

WEIGHT:
Kg 9,40

VOLUME:
0,175 m³

PACKAGING DIMENSIONS:
mm 740x450x525 h



COMPOSITION	CODE	DIGIT	UNIT PRICE
BASE WITH 4 WHEELS Ø 80 MM, 4 BUMPERS Ø 90 MM AND 1 TOP FOR DOVETAIL JOINT	PMVR95608	<ul style="list-style-type: none"> ● 0015 ● 0010 ● 0009 ● 0004 	€ 41,80
15 LT. PLASTIC BUCKET	SECC00055	<ul style="list-style-type: none"> ● 0620 ● 0618 	€ 13,90
VARNISHED REVERSIBLE HANDLE WITH 2 LINKING PINS	PMLA96088	-	€ 15,45
NEW LINE/STRONG WRINGER	STRI00030	<ul style="list-style-type: none"> ● IP15 ● IP02 ● IP09 ● IP04 	€ 54,90
KINETIC WRINGER	STRI00072	● IP09	€ 70,00

OPTIONAL	CODE	DIGIT	UNIT PRICE
VASCHETTA IN POLIPROPILENE PER MANIGLIA REVERSIBILE	PMVR95609	<ul style="list-style-type: none"> ● 0015 ● 0010 ● 0009 ● 0004 	€ 8,75

All trolleys are available also with **ROLLER / RULLY and SPEED / BOOK** wringers (see page 194).

For trolleys without wringer deduct € 25,00 from the price list

TRIS3P - 25 LT.

With NEW LINE wringer
CODE
CARR00424

UNIT PRICE
€ 110,90

- IP15 ● IP10
- IP09 ● IP04

SIZE:
mm 530x435x880 h

WEIGHT:
Kg 6,9

VOLUME:
0,175 m³

PACKAGING DIMENSIONS:
mm 740x450x525 h



With KINETIC wringer
CODE
CARR50424

UNIT PRICE
€ 126,00

TRIS3P - 15 LT.

With NEW LINE wringer
CODE
CARR00423

UNIT PRICE
€ 110,90

- IP15 ● IP10
- IP09 ● IP04

SIZE:
mm 510x435x880 h

WEIGHT:
Kg 7

VOLUME:
0,175 m³

PACKAGING DIMENSIONS:
mm 740x450x525 h



With KINETIC wringer
CODE
CARR50423

UNIT PRICE
€ 126,00

COMPOSITION	CODE	DIGIT	UNIT PRICE
BASE WITH 4 WHEELS Ø 80 MM, 4 BUMPERS Ø 90 MM WITH HOLE Ø 30 MM	PMVR95607	● 0015 ● 0010 ● 0009 ● 0004	€ 38,40
TRAY MM 365X90X180 H	MPVR94646	● 0015 ● 0010 ● 0009 ● 0004	€ 4,70
25 LT. PLASTIC BUCKET	SECC00057	● 0618	€ 13,90
NEW LINE/STRONG WRINGER	STRI00030	● IP15 ● IP02 ● IP09 ● IP04	€ 54,90
KINETIC WRINGER	STRI00072	● IP09	€ 70,00

COMPOSITION	CODE	DIGIT	UNIT PRICE
BASE WITH 4 WHEELS Ø 80 MM, 4 BUMPERS Ø 90 MM WITH HOLE Ø 30 MM	PMVR95607	● 0015 ● 0010 ● 0009 ● 0004	€ 38,40
TRAY MM 365X90X180 H	MPVR94646	● 0015 ● 0010 ● 0009 ● 0004	€ 4,70
15 LT. PLASTIC BUCKET	SECC00055	● 0618	€ 13,90
NEW LINE/STRONG WRINGER	STRI00030	● IP15 ● IP02 ● IP09 ● IP04	€ 54,90
KINETIC WRINGER	STRI00072	● IP09	€ 70,00

TRIS3P - 12+18 LT. WITH BAG SUPPORT AND TRAY

With NEW LINE wringer
CODE
CARR01776

UNIT PRICE
€ 158,30

- IP15 ● IP10
- IP09 ● IP04

SIZE:
mm 770x440x845 h

WEIGHT:
Kg 10,7

VOLUME:
0,286 m³

PACKAGING DIMENSIONS:
mm 743x453x518 h



With KINETIC wringer
CODE
CARR51776

UNIT PRICE
€ 173,40

COMPOSITION	CODE	DIGIT	UNIT PRICE
BASE WITH 4 WHEELS Ø 80 MM, 4 BUMPERS Ø 90 MM WITH HOLE Ø 30 MM	PMVR95608	● 0015 ● 0010 ● 0009 ● 0004	€ 41,80
12+18 PLASTIC BUCKET	SECC00065	● 0618	€ 27,40
VARNISHED REVERSIBLE HANDLE WITH 2 LINKING PINS	PMLA96088	-	€ 15,45
HANDLE TRAY	PMVR95609	● 0015 ● 0010 ● 0009 ● 0004	€ 8,75
50 LT. BAG SUPPORT	PMVR95610	● 0006	€ 16,15
SIDE PLASTIC SUPPORT FOR BAG WITH CASTOR Ø 80 MM	PMVR95651	● 0006	€ 12,60
HANDLE HOLDER	MPVR94778	● 0006	€ 3,35
NEW LINE/STRONG WRINGER	STRI00030	● IP15 ● IP02 ● IP09 ● IP04	€ 54,90
KINETIC WRINGER	STRI00072	● IP09	€ 70,00
OPTIONAL			
50 LT. PLASTICIZED PLS BAG WITH HOOK AND LOOP FASTENERS	SACC00012	● 0005 ● 0002 ● 0009 ● 0004	€ 31,80

All trolleys are available also with **ROLLER / RULLY** and **SPEED / BOOK** wringers (see page 194).
For trolleys without wringer deduct € 25,00 from the price list

TRIS3P - 25 LT.
WITH BAG SUPPORT AND TRAY

With **NEW LINE** wringer
CODE
CARR01772

UNIT PRICE
€ 144,90

With **KINETIC** wringer
CODE
CARR51772

UNIT PRICE
€ 160,00

- IP15 ● IP10
- IP09 ● IP04

SIZE:
mm 795x440x845 h

WEIGHT:
Kg 9,5

VOLUME:
0,297 m³

PACKAGING DIMENSIONS:
mm 743x453x518 h



TRIS3P - 15 LT.
WITH BAG SUPPORT AND TRAY

With **NEW LINE** wringer
CODE
CARR01773

UNIT PRICE
€ 144,90

With **KINETIC** wringer
CODE
CARR51773

UNIT PRICE
€ 160,00

- IP15 ● IP10
- IP09 ● IP04

SIZE:
mm 770x440x845 h

WEIGHT:
Kg 9,6

VOLUME:
0,286 m³

PACKAGING DIMENSIONS:
mm 743x453x518 h



COMPOSITION	CODE	DIGIT	UNIT PRICE
BASE WITH 4 CASTORS Ø 80 MM, 4 BUMPERS Ø 90 MM WITH HOLE Ø 30 MM	PMVR95608	<ul style="list-style-type: none"> ● 0015 ● 0010 ● 0009 ● 0004 	€ 41,80
25 LT. PLASTIC BUCKET	SECC00057	● 0618	€ 13,90
VARNISHED REVERSIBLE HANDLE WITH 2 LINKING PINS	PMLA96088	-	€ 15,45
HANDLE TRAY	PMVR95609	<ul style="list-style-type: none"> ● 0015 ● 0010 ● 0009 ● 0004 	€ 8,75
50 LT. BAG SUPPORT	PMVR95610	● 0006	€ 16,15
SIDE PLASTIC SUPPORT FOR BAG WITH CASTOR Ø 80 MM	PMVR95651	● 0006	€ 12,60
HANDLE HOLDER	MPVR94778	● 0006	€ 3,35
NEW LINE/STRONG WRINGER	STRI00030	<ul style="list-style-type: none"> ● IP15 ● IP02 ● IP09 ● IP04 	€ 54,90
KINETIC WRINGER	STRI00072	● IP09	€ 70,00
OPTIONAL	CODICE	DIGIT	PREZZO UNITARIO
50 LT. PLASTICIZED PLS BAG WITH HOOK AND LOOP FASTENERS	SACC00012	<ul style="list-style-type: none"> ● 0005 ● 0002 ● 0009 ● 0004 	€ 31,80

COMPOSITION	CODE	DIGIT	UNIT PRICE
BASE WITH 4 CASTORS Ø 80 MM, 4 BUMPERS Ø 90 MM WITH HOLE Ø 30 MM	PMVR95608	<ul style="list-style-type: none"> ● 0015 ● 0010 ● 0009 ● 0004 	€ 41,80
15 LT. PLASTIC BUCKET	SECC00055	● 0618	€ 13,90
VARNISHED REVERSIBLE HANDLE WITH 2 LINKING PINS	PMLA96088	-	€ 15,45
HANDLE TRAY	PMVR95609	<ul style="list-style-type: none"> ● 0015 ● 0010 ● 0009 ● 0004 	€ 8,75
50 LT. BAG SUPPORT	PMVR95610	● 0006	€ 16,15
SIDE PLASTIC SUPPORT FOR BAG WITH CASTOR Ø 80 MM	PMVR95651	● 0006	€ 12,60
HANDLE HOLDER	MPVR94778	● 0006	€ 3,35
NEW LINE/STRONG WRINGER	STRI00030	<ul style="list-style-type: none"> ● IP15 ● IP02 ● IP09 ● IP04 	€ 54,90
KINETIC WRINGER	STRI00072	● IP09	€ 70,00
OPTIONAL	CODICE	DIGIT	PREZZO UNITARIO
50 LT. PLASTICIZED PLS BAG WITH HOOK AND LOOP FASTENERS	SACC00012	<ul style="list-style-type: none"> ● 0005 ● 0002 ● 0009 ● 0004 	€ 31,80

All trolleys are available also with **ROLLER / RULLY and SPEED / BOOK** wringers (see page 194).

For trolleys without wringer deduct € 25,00 from the price list

TRIS2P - 25 LT. WITH BAG SUPPORT 70 LT.

With **NEW LINE** wringer
CODE
CARR00428

UNIT PRICE
€ 162,60

With **KINETIC** wringer
CODE
CARR50428

UNIT PRICE
€ 177,70

- IP15 ● IP10
- IP09 ● IP04

SIZE:
mm 830x435x900 h

WEIGHT:
Kg 9,15

VOLUME:
0,175 m³

PACKAGING DIMENSIONS:
mm 740x450x525 h



TRIS2P - 15 LT. WITH BAG SUPPORT 70 LT.

With **NEW LINE** wringer
CODE
CARR00427

UNIT PRICE
€ 162,60

With **KINETIC** wringer
CODE
CARR50427

UNIT PRICE
€ 177,70

- IP15 ● IP10
- IP09 ● IP04

SIZE:
mm 800x435x900 h

WEIGHT:
Kg 9,25

VOLUME:
0,175 m³

PACKAGING DIMENSIONS:
mm 740x450x525



COMPOSITION	CODE	DIGIT	UNIT PRICE
BASE WITH 4 CASTORS Ø 80 MM, 4 BUMPERS Ø 90 MM WITH HOLE Ø 30 MM	PMVR95608	<ul style="list-style-type: none"> ● 0015 ● 0010 ● 0009 ● 0004 	€ 41,80
25 LT. PLASTIC BUCKET	SECC00057	● 0618	€ 13,90
VARNISHED REVERSIBLE HANDLE WITH 2 LINKING PINS, 2 DOVETAIL JOINT AND PLASTIC TOP AND 4 CLIPS FOR BAG	PMLA96090	-	€ 52,80
NEW LINE/ STRONG WRINGER	STRI00030	<ul style="list-style-type: none"> ● IP15 ● IP02 ● IP09 ● IP04 	€ 54,90
KINETIC WRINGER	STRI00072	● IP09	€ 70,00
OPTIONAL	CODICE	DIGIT	PREZZO UNITARIO
PLASTIC LID 70 LT.	MPVR94554	● 0002	€ 18,00
TRAY	MPVR94603	<ul style="list-style-type: none"> ● 0015 ● 0010 ● 0009 ● 0004 	€ 7,35
SUPPORT TRAY (2 PCS)	PMLA95998	-	€ 28,55
ROLL HOLDER WITH DOVETAIL JOINT	POCA00006	● 0006	€ 18,00
70 LT. PLASTICIZED PLS BAG WITH HOOK AND LOOP FASTENERS, YELLOW	SACC00013	● 0004	€ 33,50

COMPOSITION	CODE	DIGIT	UNIT PRICE
BASE WITH 4 CASTORS Ø 80 MM, 4 BUMPERS Ø 90 MM WITH HOLE Ø 30 MM	PMVR95608	<ul style="list-style-type: none"> ● 0015 ● 0010 ● 0009 ● 0004 	€ 41,80
15 LT. PLASTIC BUCKET	SECC00055	● 0618	€ 13,90
VARNISHED REVERSIBLE HANDLE WITH 2 LINKING PINS, 2 DOVETAIL JOINT AND PLASTIC TOP AND 4 CLIPS FOR BAG	PMLA96090	-	€ 52,80
NEW LINE/ STRONG WRINGER	STRI00030	<ul style="list-style-type: none"> ● IP15 ● IP02 ● IP09 ● IP04 	€ 54,90
KINETIC WRINGER	STRI00072	● IP09	€ 70,00
OPTIONAL	CODICE	DIGIT	PREZZO UNITARIO
PLASTIC LID 70 LT.	MPVR94554	● 0002	€ 18,00
TRAY	MPVR94603	<ul style="list-style-type: none"> ● 0015 ● 0010 ● 0009 ● 0004 	€ 7,35
SUPPORT TRAY (2 PCS)	PMLA95998	-	€ 28,55
ROLL HOLDER WITH DOVETAIL JOINT	POCA00006	● 0006	€ 18,00
70 LT. PLASTICIZED PLS BAG WITH HOOK AND LOOP FASTENERS, YELLOW	SACC00013	● 0004	€ 33,50

All trolleys are available also with **ROLLER / RULLY and SPEED / BOOK** wringers (see page 194).

For trolleys without wringer deduct € 25,00 from the price list _____

**TRIS3P - 12+18 LT.
CON SUPPORTO SACCO DA 70 LT.**

With **NEW LINE** wringer
CODE
CARR00429

UNIT PRICE
€ 173,50

With **KINETIC** wringer
CODE
CARR50429

UNIT PRICE
€ 188,60

- IP15 ● IP10
- IP09 ● IP04

SIZE:
mm 940x435x900 h

WEIGHT:
Kg 10,3

VOLUME:
0,190 m³

PACKAGING DIMENSIONS:
mm 790x445x540 h



COMPOSITION	CODE	DIGIT	UNIT PRICE
BASE WITH 4 CASTORS Ø 80 MM, 4 BUMPERS Ø 90 MM WITH HOLE Ø 30 MM	PMVR95608	<ul style="list-style-type: none"> ● 0015 ● 0010 ● 0009 ● 0004 	€ 41,80
12+18 PLASTIC BUCKET	SECC00065	● 0618	€ 27,40
VARNISHED REVERSIBLE HANDLE WITH 2 LINKING PINS, 2 DOVETAIL JOINT AND PLASTIC TOP AND 4 CLIPS FOR BAG	PMLA96090	-	€ 52,80
NEW LINE/ STRONG WRINGER	STRI00030	<ul style="list-style-type: none"> ● IP15 ● IP02 ● IP09 ● IP04 	€ 54,90
KINETIC WRINGER	STRI00072	● IP09	€ 70,00

OPTIONAL	CODE	DIGIT	UNIT PRICE
PLASTIC LID 70 LT.	MPVR94554	● 0002	€ 18,00
TRAY	MPVR94603	<ul style="list-style-type: none"> ● 0015 ● 0010 ● 0009 ● 0004 	€ 7,35
SUPPORT TRAY (2 PCS)	PMLA95998	-	€ 28,55
ROLL HOLDER WITH DOVETAIL JOINT	POCA00006	● 0006	€ 18,00
70 LT. PLASTICIZED PLS BAG WITH HOOK AND LOOP FASTENERS, YELLOW	SACC00013	● 0004	€ 33,50

All trolleys are available also with **ROLLER / RULLY and SPEED / BOOK** wringers (see page 194).
For trolleys without wringer deduct € 25,00 from the price list

BRIX 2.0

THE EVOLUTION

**DESIGNED TO BE RESISTANT,
EASY TO USE, STABLE AND DURABLE.**



NEW FEATURES

- 01. Ø 125 MM WHEELS**
 - ▶ EXTRA SMOOTHNESS, MAXIMUM DIRECTIONALITY AND QUIETNESS
- 02. REINFORCED BASE**
 - ▶ HIGH STRENGTH AND LONG LASTING QUALITY
- 03. NEW WHEEL FASTENING SYSTEM**
 - ▶ IMPROVED STRENGTH AND SIMPLIFIED REPLACEMENT OPERATIONS
- 04. REINFORCED AND NON-MARKING BUMPERS**
 - ▶ TO AVOID SCRATCHES AND WALLS DAMAGES
- 05. IMPROVED DOORS**
 - ▶ TO GUARANTEE SAFETY, SOLIDITY AND ROBUSTNESS TO THE ENTIRE TROLLEY, SAFEGUARDING THE CONTENTS
- 06. STRENGTHENED BAG SUPPORT**
 - ▶ FOR BETTER MANEUVERABILITY AND DIRECTIONALITY EVEN WHEN LOADED
- 07. FOLDING BAG SUPPORT**
 - ▶ FOR AN EASIER STORAGE EVEN IN LUMBER ROOMS
- 08. "LID-STOP" SYSTEM**
 - ▶ IS THE NEW IPC SOLUTION TO LIMIT THE LID'S OPENING UP TO 75° (COMPARED TO THE 100° OF THE PREVIOUS VERSION)
- 09. NEW REINFORCED COVERBAG**
 - ▶ FOR A GREATER STRUCTURAL SOLIDITY



CLEANING TROLLEYS RANGE /

BLACK IS GREEN™ RANGE



EXTREME MODULARITY FOR ALL NEEDS

RECYCLED PLASTIC

> 75% OF RECYCLED PLASTIC



IPC
BRIX

MAIN COMPETITOR

< 35%

"The declaration of recycling percentage (Polypropylene 20/25 Black) is a consistent consequence of transparent documentation of supply chain, quality processes, management requirements, quality structure and well organized supporting processes."

TÜV NORD CERT GMBH

INNOVATIONS

- Black is Green products uses **RECYCLED PLASTIC > 75%**
- **THE IPC MATERIALS TECHNOLOGY DOUBLES THE RECYCLABILITY INDEX** than traditional recycled materials in an environmentally responsible manner
- Ideal for public communities, industries and horeca

TROLLEYS

- **DOLLY/CLEVY**
- **ECOMIX**
- **DAM**
- **BIS**
- **REVOLUTION**
- **BRIX LIGHT OFFICE SLIM**
- **BRIX LIGHT PT SLIM**
- **BRIX LIGHT COLLECTION SLIM**
- **BRIX COMPACT BASIC**
- **BRIX COMPACT OFFICE**
- **BRIX COMPACT PT**
- **BRIX COMPACT COLLECTION**
- **CLIMBER**
- **BRIX SCHOOL OUTDOOR**
- **BRIX SCHOOL**
- **BRIX PT**
- **BRIX SDS**



BLACK
IS GREEN™

DOLLY/CLEVY
BLACK IS GREEN™

CODE
SECC00044
0099

UNIT PRICE
€ 76,60

SIZE
mm 540 x 280 x 420 h



#01 DETAIL

**FLEXIBLE WATER
PIPE FOR FILLING
BUCKETS**



Optional

ECOMIX
BLACK IS GREEN™

CODE
SECC00042
1P99

UNIT PRICE
€ 76,90*

SIZE
mm 540 x 370 x 810 h

Rubber wheels
Ø 80 mm



#02 DETAIL

**ECOMIX
MOUSSE SHIM**



#03 DETAIL

**DOLLY/CLEVY
MOUSSE SHIM**



DAM
BLACK IS GREEN™

CODE with trays
CARR02049
IPGX

UNIT PRICE
€ 115,70

CODE without trays
CARR02050
IPGX

UNIT PRICE
€ 86,80

SIZE
mm 770 x 360 x 880 h



DAM

Metal wheels Ø 80 mm with bumpers	Yes
Rubber wheels Ø 80 mm with bumpers	-
Double bucket with wringer and mousse shim	Yes - 12+18 lt.
2 gray trays	-
Reversible handle with tray	-
Handle holder	Yes

TROLLEY
with trays
€ 115,70

CODE
CARR02049.IPIX



CODE
CARR02049.IPBX



CODE
CARR02049.IPRX



CODE
CARR02049.IPYX



TROLLEY
without trays
€ 86,80

CODE
CARR02050.IPIX



CODE
CARR02050.IPBX



CODE
CARR02050.IPRX



CODE
CARR02050.IPYX



#01 DETAIL

FLEXIBLE WATER PIPE FOR FILLING BUCKETS



Optional

#02 DETAIL

NEW LINE/STRONG WRINGER



#03 DETAIL

HANDLE HOLDER

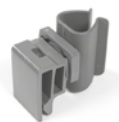

#04 DETAIL

BUMPERS



For trolleys without wringer deduct € 25,00 from the price list

BIS
BLACK IS GREEN™

With NEW LINE wringer
CODE (2X25 lt.)
CARR00239 - IP99

UNIT PRICE
€ 108,80

With KINETIC wringer
CODE (2X25 lt.)
CARR50239 - IP99

UNIT PRICE
€ 123,90

CODE (2X15 lt.)
CARR00234 - IP99

UNIT PRICE
€ 108,80

CODE (2X15 lt.)
CARR50234 - IP99

UNIT PRICE
€ 123,90

BIS
BLACK IS GREEN™
without tray and mousse shim

With NEW LINE wringer
CODE (2X25 lt.)
CARR00434 - IP99

UNIT PRICE
€ 104,40

With KINETIC wringer
CODE (2X25 lt.)
CARR50434 - IP99

UNIT PRICE
€ 119,95

CODE (2X15 lt.)
CARR00430 - IP99

UNIT PRICE
€ 104,40

CODE (2X15 lt.)
CARR50430 - IP99

UNIT PRICE
€ 119,95



SIZE
mm 810 x 435 x 880 h

BIS

Metal wheels Ø 80 mm with bumpers	Yes
Rubber wheels Ø 80 mm with bumpers	-
Single bucket with wringer	-
Double bucket with wringer and mousse shim	Yes - 2x15 lt. or 2x25 lt.
2 gray trays	-
Reversible handle with tray	Yes
Handle holder	Yes

#01 DETAIL

**FLEXIBLE WATER
PIPE FOR FILLING
BUCKETS**



Optional

#03 DETAIL

MOUSSE SHIM



#04 DETAIL

BUMPERS



REVOLUTION
BLACK IS GREEN™

With NEW LINE wringer
CODE
CARR01287

UNIT PRICE
€ 204,70

With KINETIC wringer
CODE
CARR51287

UNIT PRICE
€ 219,80

REVOLUTION
BLACK IS GREEN™ WITHOUT BAG AND LID

With NEW LINE wringer
CODE
CARR01907

UNIT PRICE
€ 175,60

With KINETIC wringer
CODE
CARR51907

UNIT PRICE
€ 190,70

SIZE
mm 890 x 675 x 1060 h



REVOLUTION

Rubber wheels Ø 100 mm	Yes
Black doors with lock	-
Two drawers green and gray	-
Two 15 lt. buckets	Yes
Wringer	Yes
Bag support (120 lt.) with lid	Yes
Two 6 lt. buckets	Yes
Mop support	Yes
Set of handle, tools and safety sign holders	-

#01 DETAIL

6 LT. BUCKET



#02 DETAIL

BAG 120 LT.
WITH FRONTAL ZIPPER



For trolleys without wringer deduct € 25,00 from the price list

NEW

2P MINI

the practical and essential solution



2P MINI BLACK IS GREEN™

2x15 l version

CODE
CARR53039-IP99

SIZE
mm 690 x 495 x 910 h

UNIT PRICE
€ 125,00

2x25 l version

CODE
CARR53040-IP99

SIZE
mm 690 x 495 x 910 h

UNIT PRICE
€ 125,00



2P MINI, is a practical and essential solution.

Its small dimensions make it ideal for all environments.

Designed to be both light and resistant.

The trolley is equipped with two buckets (25l or 15l), one support tray and the new Kinetic wringer, granting higher manoeuvrability with its innovative ergonomic handle.

BRIX LIGHT SLIM

BLACK IS GREEN™

BRIX LIGHT OFFICE SLIM

BLACK IS GREEN™

WITH NEW LINE WRINGER
 CODE not assembled
CARR03016-IP99

UNIT PRICE
€ 269,00

WITH KINETIC WRINGER
 CODE not assembled
CARR53016-IP99

UNIT PRICE
€ 284,10

SIZE
 mm 900x680x1220 h



WEIGHT
 16,8 Kg

BRIX LIGHT PT SLIM

BLACK IS GREEN™

CODE Not assembled
CARR03017-IP99

UNIT PRICE
€ 262,90

SIZE
 mm 890x600x1130 h



WEIGHT
 14,9 Kg

BRIX LIGHT COLLECTION SLIM

BLACK IS GREEN™

CODE Not assembled
CARR03018-IP99

UNIT PRICE
€ 212,10

SIZE
 mm 960x590x1015 h



WEIGHT
 11,45 Kg

COMPOSITION	CODE	DIGIT	OFFICE QUANTITY	PT QUANTITY	COLLECTION QUANTITY
120 l Bag Support With Bumpers	MPVR94816	0099	1	1	2
15 l Bucket Black is Green™ - Blue Handle	SECC00055	0599	1	-	-
15 l Bucket Black is Green™ - Red Handle	SECC00055	0299	1	-	-
22 l Black is Green Bucket with Blue Handle	SECC70027	NNNB	-	1	-
22 l Black is Green Bucket with Red Handle	SECC70027	NNNR	-	1	-
6 l Bucket Black - Blue Handle	SECC00056	0599	1	-	-
6 l Bucket Black - Red Handle	SECC00056	0299	1	-	-
6 l Tray	MPVR10852	0008	1	-	-
Aluminum Cylindrical Support 357 mm for Brix Light	PRAL00115		2	2	2
Aluminum Cylindrical Support 388 mm for Brix Light	PRAL00116		2	2	2
Aluminum Cylindrical Support 803 mm Type 1	PRAL00081	0008	2	2	2
Base Complete With 4 Rubber Wheels Ø 100 mm (Metal Fork)	PMVR06657	0099	1	1	1
Bracing Tube for Brix Light	LAFN11432	0008	2	2	2
Cover for Brix Light Upper Support Black	MPVR10683	0099	2	2	2
Cover for Brix Light Upper Support Grey	MPVR10683	0008	4	4	4
Dovetail Insert Black	MPVR94858	0099	4	4	4
Dovetail Insert Grey	MPVR94858	0008	4	4	2
Hanging Hook For 22 l Bucket	PMLA96095	0008	-	1	-
Insert for Cylindrical Support and Bracing Tube for Brix Light	MPVR10681	0008	4	4	4
Lid for 22 l Bucket Black	SECC70043		-	2	-
Lower Support for Brix Light	MPVR10853	0008	1	1	1
Metal Wringer Support Complete With Plastic Inserts For Base	PMLA96093	0008	1	-	-
Mop Support	MPVR94835	0099	1	1	1
New Line/Strong Wringer - Black	STRI00030	IPGX	1	-	-
Pair of Bag Support Holders Fixed	PMVR06722	0013	1	1	2
Pair of Supports for Bag Support Holders	PMVR06724	0013	1	1	2
Round Cover For Base Ø 25 mm	MPVR94871	0099	2	2	2
Round Cover For Base Ø 30 mm	MPVR94704	0006	-	1	2
Round Cover For Brix Light Bracing Tube	MPVR10849	0008	2	2	2
Rubber Handle Holder Complete - For Brix PT Version	MPVR94817	0013	-	1	-
Set Of 6 Covers For Aluminum Supports And Wrench	MPVR94818	0006	1	1	1
Set Of Handle, Tools And Safety Sign Holders	MPVR94819	0008	1	1	1
Slot Covering Cap Black	MPVR94857	0099	2	2	2
Slot Covering Cap Grey	MPVR94857	0008	1	1	1
Slot Covering Cap With "Made in Italy"	MPVR94856	0099	1	1	1
Support for 6 l tray (single)	MPVR10679	0008	2	-	-
Upper Plate With Brix And IPC Logo	MPVR04776	0099	1	1	1
Upper Support For 22 l Bucket	COME00267	0008	-	1	-
Upper Support for Brix Light	MPVR10680	0008	1	1	1

BRIX COMPACT

BLACK IS GREEN™

STARTING
from the same
BASIC



and
BY ADDING
A PACK
you can obtain till



3 DIFFERENT TROLLEYS,
one for each application.

BRIX COMPACT BASIC

BLACK IS GREEN™

CODE CARR01797

UNIT PRICE
€ 382,00



PACK OFFICE

CODE KTRI04734

**2X15 LT. DOUBLE
BUCKET**
BLACK IS GREEN™

WITH
**NEW LINE / STRONG
WRINGER**

UNIT PRICE
€ 150,80

CODE KTRI54734

**2X15 LT. DOUBLE
BUCKET**
BLACK IS GREEN™

WITH
**KINETIC / STRONG
WRINGER**

UNIT PRICE
€ 165,90

PACK PT

CODE KTRI05222

22 LT. DOUBLE BUCKET
BLACK IS GREEN™

WITH RED AND BLUE HANDLE
FOR WASHING & DISINFECTION

UNIT PRICE
€ 145,40

PACK COLLECTION

CODE KTRI04735

**120 LT.
BAG SUPPORT**
WITH LID

UNIT PRICE
€ 107,70

NEW

3P COMPACT

the compact solution for high performance

3P COMPACT BLACK IS GREEN™

12 + 18 L VERSION

CODE
CARR03081-IP99

DIMENSION
mm 900 x 510 x 1084 h

WEIGHT
12,30 kg

UNIT PRICE
€ 172,00

15 L VERSION

CODE
CARR03080-IP99

DIMENSION
mm 750 x 510 x 1084 h

WEIGHT
11,45 kg

UNIT PRICE
€ 161,00

25 L VERSION

CODE
CARR02958-IP99

DIMENSION
mm 777 x 510 x 1084 h

WEIGHT
11,60 kg

UNIT PRICE
€ 161,00

3P COMPACT PT

CODE
CARR03130-0099

DIMENSION
mm 777 x 510 x 1084 h

WEIGHT
12,00 kg

UNIT PRICE
€ 220,00



3P COMPACT is the new compact multifunction trolley used for waste collection and for washing.

The trolley is equipped with an easy-to-assemble painted metal push handle, two swivel brackets complete with 6 l buckets, New-Line wringer and a storage tray.

BRIX COMPACT BASIC BLACK IS GREEN™

CODE Assembled
CARR01797

UNIT PRICE
€ 387,70

DIMENSION
mm 490 x 575 x 1220 h



COMPOSITION

	CODE	DIGIT	QUANTITY
35 l Bag with string - red	SACC00038	0002	1
4 Covers for side panel	MPVR94820	0013	2
6 l Bucket Black is green™ - blue handle	SECC00056	0599	1
6 l Bucket Black is green™ - red handle	SECC00056	0299	1
Adaptator antirotation compact	MPVR04775	0013	4
Aluminum cylindrical support 803 mm type 1	PRAL00081	0008	4
Black lid for countertop complete with plastic lock	MPVR94841	0613	1
Bottom insert for countertop	MPVR94839	0099	3
Door complete with plastic lock - green	MPVR94847	0999	2
Dovetail hooking	MPVR94680	0006	2
Dovetail insert	MPVR94858	0099	8
Dovetail insert with 4 holes	MPVR04772	0013	2
Dovetail insert with slot	MPVR04771	0013	2
Drawer complete with frontal colored panel without closure - green	PMVR95685	0999	1
Drawer complete with frontal colored panel without closure - grey	PMVR95685	0699	1
Fixing junction for wheels for compact trolleys	MPVR04773	0013	4
Flat insert for countertop	MPVR94851	0099	2
Hinges (double version)	MPVR94821	0008	2
Holder for tools complete	PMVR95638	0006	1
Lateral cover for aluminum cylindrical support black	MPVR04769	0099	6
Lateral panel neutral	MPVR94843	0099	3
Lateral panel with Black is green™ logo	MPVR10664	0099	1
Lever holding bag	MPVR94633	0006	2
Pushing handle	MPVR94594	0099	1
Rubber handle holder complete	PMVR01545	0006	1
Rubber insert for 6 l buckets	LAMU00021		1
Rubber wheel (nylon fork) ø 125 mm	RTRT00572	0006	4
Safety sign holder complete	PMVR95639	0006	1
Screw with cross shape M5x18	VTVR00333		8
Self-locking nut inox M5	VTDD92751		8
Set of 6 covers for aluminum supports and wrench	MPVR94818	0006	1
Slot covering cap with "Made in Italy"	MPVR94856	0099	1
Small countertop	MPVR94850	0099	3
Transparent lid for countertop complete with plastic lock	MPVR94841	0670	1
Upper plate with Brix and IPC logo	MPVR04776	0099	1

BRIX COMPACT OFFICE
BLACK IS GREEN™

CODE Assembled
CARR01847

UNIT PRICE
€ 538,60

DIMENSION
mm 845 x 680 x 1220 h



BRIX COMPACT PT
BLACK IS GREEN™

CODE Assembled
CARR02323

UNIT PRICE
€ 553,70

DIMENSION
mm 845 x 575 x 1220 h



BRIX COMPACT COLLECTION
BLACK IS GREEN™

CODE Assembled
CARR01849

UNIT PRICE
€ 495,50

DIMENSION
mm 905 x 575 x 1220 h



COMPOSITION	CODE	DIGIT	QUANTITY OFFICE	QUANTITY PT	QUANTITY COLLECTION
120 l Bag Support With Bumpers	MPVR94816	0099	-	-	1
120 l Grey Bag With Frontal Zipper	SACC00023	0006	-	-	1
15 l Bucket Black is Green™ - Blue Handle	SECC00055	0599	1	-	-
15 l Bucket Black is Green™ - Red Handle	SECC00055	0299	1	-	-
22 l Black is Green Bucket with Blue Handle	SECC70027	NNNB	-	1	-
22 l Black is Green Bucket with Red Handle	SECC70027	NNNR	-	1	-
35 l Bag With String - Red	SACC00038	0002	1	1	1
4 Covers For Side Panel	MPVR94820	0013	2	2	2
6 l Bucket Black - Blue Handle	SECC00056	0599	1	1	1
6 l Bucket Black - Red Handle	SECC00056	0299	1	1	1
Adaptator Antirotation Compact	MPVR04775	0013	2	2	2
Aluminum Cylindrical Support 803 mm Type 1	PRAL00081	0008	4	4	4
Base With 2 Wheel Supports And 2 Wheels Ø 80 mm	PMVR01539	0099	1	1	1
Black Lid For Countertop Complete With Plastic Lock	MPVR94841	0613	1	1	1
Bottom Insert For Countertop	MPVR94839	0099	3	3	3
Door Complete With Plastic Lock - Green	MPVR94847	0099	2	2	2
Dovetail Hooking	MPVR94680	0006	2	2	-
Dovetail Insert	MPVR94858	0099	6	6	4
Dovetail Insert With 4 Holes	MPVR04772	0013	2	2	-
Dovetail Insert With Slot	MPVR04771	0013	2	-	2
Drawer Complete With Frontal Colored Panel Without Closure - Green	PMVR95685	0099	1	1	1
Drawer Complete With Frontal Colored Panel Without Closure - Grey	PMVR95685	0699	1	1	1
Fixing Junction For Wheels For Compact Trolleys	MPVR04773	0013	4	4	4
Flat Insert For Countertop	MPVR94851	0099	2	2	2
Handle Holder Complete	PMVR95637	0006	-	-	1
Hinges (Double Version)	MPVR94821	0008	2	2	2
Holder For Tools Complete	PMVR95638	0006	1	1	1
Lateral Cover For Aluminum Cylindrical Support Black	MPVR04769	0099	4	6	6
Lateral Cover With Handle Holder For Aluminum Cylindrical Support Black	PMVR01538	0099	2	-	-
Lateral Panel Neutral	MPVR94843	0099	3	3	3
Lateral Panel With Black is Green Logo	MPVR10664	0099	1	1	1
Lever Holding Bag	MPVR94633	0006	2	2	2
Lid for 22 l Bucket Black	SECC70043	-	-	2	-
Lid For Bag Support	MPVR94837	0013	-	-	1
Metal Wringer Support Complete For Base For Bag	COME00310	0008	1	-	-
Mop Support	MPVR94835	0099	1	-	1
New Line/Strong Wringer	STRI00030	IPGX	1	-	-
Pair of Bag Support Holders Fixed	PMVR06722	0013	-	-	1
Pair of Supports for Bag Support Holders	PMVR06724	0013	-	-	1
Pushing Handle	MPVR94594	0099	1	1	-
Rubber Handle Holder Complete	PMVR01545	0006	1	1	1
Rubber Handle Holder Complete - For Brix PT Version	PMVR06633	0013	-	1	-
Rubber Insert For 6 l Buckets	LAMU00021	-	1	1	1
Rubber Wheel (Nylon Fork) Ø 125 mm	RTRT00572	0006	4	4	4
Safety Sign Holder Complete	PMVR95639	0006	1	1	1
Screw With Cross Shape M5X18	VTVR00333	-	4	4	-
Self-Locking Nut Inox M5	VTDD92751	-	4	4	-
Set Of 6 Covers For Aluminum Supports And Wrench	MPVR94818	0006	1	1	1
Shock Absorber for 120 l Lid	MPVR10546	-	-	-	1
Slot Covering Cap With "Made in Italy"	MPVR94856	0099	1	1	1
Small Countertop	MPVR94850	0099	3	3	3
Transparent Lid For Countertop Complete With Plastic Lock	MPVR94841	0670	1	1	1
Upper Plate With Brix And IPC Logo	MPVR04776	0099	1	1	1
Upper Support For 22 l Bucket	COME00267	0008	-	1	-

BRIX CLIMBER

BLACK IS GREEN™

CODE
CARR02410 - IP99

UNIT PRICE
€ 527,00

DIMENSION
mm 660 x 520 x1215 h

WEIGHT
Kg 19,5



COMPOSITION

	CODE	DIGIT	QUANTITY
4 Covers for side panel	MPVR94820	0013	2
Adaptator antirotation compact	MPVR04775	0013	4
Aluminum cylindrical support 803 mm type 1	PRAL00081	0008	2
Black lid for countertop complete with plastic lock	MPVR94841	0613	1
Bottom insert for countertop	MPVR94839	0099	4
Brix adjustable handle short version kit (with 2 cylindrical supports)	PMVR06377	0008	1
Bumper for wheel	MPVR94855	0099	2
Cover nut cap M12	MPVR11537		2
Door complete with metal key lock with key - green	MPVR04779	0999	2
Dovetail insert	MPVR94858	0099	9
Dovetail insert with slot	MPVR04771	0013	3
Drawer complete with frontal colored panel with metal key lock - green	PMVR06628	0999	1
Drawer complete with frontal colored panel with metal key lock - grey	PMVR06628	0699	1
Fixing junction for wheels for compact trolleys	MPVR04773	0013	4
Flat insert for countertop	MPVR94851	0099	2
Hexagon socket head screw M10	VTVR00622		2
Hexagon socket head screw M12	VTVR01017		2
Hinges (double version)	MPVR94821	0008	1
Holder for tools complete	PMVR95638	0006	1
Lateral cover for aluminum cylindrical support black	MPVR04769	0099	6
Lateral panel neutral	MPVR94843	0099	3
Lateral panel with Black is green™ logo	MPVR10664	0099	1
Metal wheel ø 80 mm	RTRT99663		2
Ø 300 mm wheel support	COME00339		1
Plug for ø 300 mm wheel	MPVR11980	0013	2
Rubber handle holder complete	PMVR01545	0006	1
Rubber wheel ø 300 mm	RTRT00671		2
Safety sign holder complete	PMVR95639	0006	1
Self-locking nut M12	VTDD00276		2
Set of 6 covers for aluminum supports and wrench	MPVR94818	0006	1
Slot covering cap with "Made in Italy"	MPVR94856	0099	1
Small countertop	MPVR94850	0099	3
Transparent lid for countertop complete with plastic lock	MPVR94841	0670	1
Upper plate with Brix / IPC logo	MPVR04776	0099	1
Upper plate with Brix logo	MPVR94873	0099	1
Washer	VTRS93806		2

BRIX SCHOOL OUTDOOR

WITH NEW LINE WRINGER
 CODE Assembled
CARR02688 - IP99

UNIT PRICE
€ 670,10

WITH KINETIC WRINGER
 CODE Assembled
CARR52688 - IP99

UNIT PRICE
€ 685,20

DIMENSION
 mm 1240 x 680 x 1040 h

WEIGHT
 Kg 29,3



COMPOSITION	CODE	DIGIT	QUANTITY
120 l Bag Support With Bumpers	MPVR94816	0099	1
15 l Bucket Black is Green™ - Blue Handle	SECC00055	0599	1
15 l Bucket Black is Green™ - Red Handle	SECC00055	0299	1
Aluminum Cylindrical Support 803 mm Type 1	PRAL00081	0008	4
Base Complete With 2 Rear Rubber Wheels Ø 300 mm And 2 Front Rubber Wheels Ø 125 mm Deluxe with 2 Bumpers	PMVR06615	0099	1
Base For Bag	PMVR95682	0099	1
Black Lid For Countertop Complete With Metal Key Lock Without Key	MPVR94838	0013	1
Bottom Insert For Countertop	MPVR94839	0099	2
Cover For Lateral Panel	MPVR94861	0013	8
Door Complete With Plastic Lock - Green	MPVR94847	0999	4
Dovetail Insert	MPVR94858	0099	6
Flat Insert For Countertop	MPVR94851	0099	2
Hinges (Double Version)	MPVR94821	0008	1
Lateral Cover For Aluminum Cylindrical Support Black	MPVR04769	0099	4
Lateral Panel Neutral	MPVR94843	0099	3
Lateral Panel With Black is Green Logo	MPVR10664	0099	1
Lid For Bag Support	MPVR94837	0013	1
Metal Wringer Support Complete	PMLA96093	0008	1
Mop Support	MPVR94835	0099	1
New Line/Strong Wringer	STRI00030	IPGX	1
Pair of Bag Support Holders Fixed	PMVR06722	0013	1
Pair of Brix Lock Keys	CHVR00056		1
Pair of Supports for Bag Support Holders	PMVR06724	0013	1
Set Of 6 Covers For Aluminum Supports And Wrench	MPVR94818	0006	1
Set Of Handle, Tools And Safety Sign Holders	MPVR94819	0006	1
Shock Absorber for 120 l Lid	MPVR10546		1
Slot Covering Cap	MPVR94857	0099	1
Slot Covering Cap With "Made in Italy"	MPVR94856	0099	1
Small Countertop	MPVR94850	0099	2
Transparent Lid For Countertop Complete With Plastic Lock	MPVR94841	0670	1
Upper Plate With Brix And IPC Logo	MPVR04776	0099	1

BRIX SCHOOL
BLACK IS GREEN™

WITH NEW LINE WRINGER
CODE Assembled
CARR01279 - IP99647AST

UNIT PRICE
€ 538,00

WITH KINETIC WRINGER
CODE Assembled
CARR01279 - IP99829AST

UNIT PRICE
€ 553,10

WITH NEW LINE WRINGER
CODE Disassembled
CARR01279 - IP99647SST

UNIT PRICE
€ 515,60

WITH KINETIC WRINGER
CODE Disassembled
CARR01279 - IP99829SST

UNIT PRICE
€ 530,70



WITH FOLDING KIT
CODE Assembled
CARR03090 - IP99

UNIT PRICE
€ 543,40

DIMENSION
mm 1245 x 680 x 1040 h



COMPOSITION	CODE	DIGIT	QUANTITY
120 l Bag Support With Bumpers	MPVR94816	0099	1
15 l Bucket Black is Green™ - Blue Handle	SECC00055	0599	1
15 l Bucket Black is Green™ - Red Handle	SECC00055	0299	1
4 Covers For Side Panel	MPVR94820	0013	2
Aluminum Cylindrical Support 803 mm Type 1	PRAL00081	0008	4
Bar For Pedal	PMVR06751	0006	1
Base Complete With 4 Rubber Wheels Ø 125 mm (Nylon Fork) With Brakes And 4 Bumpers	PMVR95671	0099	1
Base For Bag With 2 Wheel Supports, 2 Wheels Ø 80 mm And Pedal Support	PMVR95681	0099	1
Black Lid For Countertop Complete With Metal Key Lock Without Key	MPVR94838	0013	1
Bottom Insert For Countertop	MPVR94839	0099	2
Door Complete With Plastic Lock - Green	MPVR94847	0999	4
Dovetail Insert	MPVR94858	0099	6
Flat Insert For Countertop	MPVR94851	0099	2
Hinges (Double Version)	MPVR94821	0008	1
Lateral Cover For Aluminum Cylindrical Support Black	MPVR04769	0099	4
Lateral Panel Neutral	MPVR94843	0099	3
Lateral Panel With Black is Green Logo	MPVR10664	0099	1
Lid For Bag Support	MPVR94837	0013	1
Metal Wringer Support Complete	PMLA96093	0008	1
Mop Support	MPVR94835	0099	1
New Line/Strong Wringer	STRI00030	IPGX	1
Pair of Bag Support Holders Fixed	PMVR06722	0013	1
Pair of Brix Lock Keys	CHVR00056		1
Pair of Supports for Bag Support Holders	PMVR06724	0013	1
Pedal	MPVR94676	0006	1
Round Cover For Base Ø 25 mm	MPVR94871	0099	2
Set Of 1 Upper Plate With Brix/IPC Logo, 1 Slot Covering Cap And 1 Slot Covering Cap With "Made in Italy"	MPVR94920	0099	1
Set Of 6 Covers For Aluminum Supports And Wrench	MPVR94818	0006	1
Set Of Handle, Tools And Safety Sign Holders	MPVR94819	0006	1
Shock Absorber for 120 l Lid	MPVR10546		1
Small Countertop	MPVR94850	0099	2
Transparent Lid For Countertop Complete With Plastic Lock	MPVR94841	0670	1

TROLLEYS / BLACK IS GREEN

**BRIX PT
BLACK IS GREEN™**

CODE Assembled
CARR01860
IP99457AST

UNIT PRICE
€ 581,60

WITH FOLDING KIT
CODE Assembled
CARR03091 - IP99

UNIT PRICE
€ 587,00

CODE Disassembled
CARR01860
IP99457SST

UNIT PRICE
€ 554,70



Folding Kit



DIMENSION
mm 1245 x 610 x 1110 h

COMPOSITION	CODE	DIGIT	QUANTITY
120 l Bag Support With Bumpers	MPVR94816	0099	1
22 l Black is Green Bucket with Blue Handle	SECC70027	NNNB	1
22 l Black is Green Bucket with Red Handle	SECC70027	NNNR	1
4 Covers For Side Panel	MPVR94820	0013	2
Aluminum Cylindrical Support 803 mm Type 1	PRAL00081	0008	4
Bar For Pedal	PMVR06751	0006	1
Base Complete With 4 Rubber Wheels Ø 125 mm (Nylon Fork) With Brakes And 4 Bumpers	PMVR95671	0099	1
Base For Bag With 2 Wheel Supports, 2 Wheels Ø 80 mm And Pedal Support	PMVR95681	0099	1
Black Lid For Countertop Complete With Metal Key Lock Without Key	MPVR94838	0013	1
Bottom Insert For Countertop	MPVR94839	0099	2
Door Complete With Plastic Lock - Green	MPVR94847	0999	4
Dovetail Insert	MPVR94858	0099	4
Flat Insert For Countertop	MPVR94851	0099	2
Hanging Hook For 22 l Bucket	PMLA96095	0008	1
Hinges (Double Version)	MPVR94821	0008	1
Lateral Cover For Aluminum Cylindrical Support Black	MPVR04769	0099	4
Lateral Panel Neutral	MPVR94843	0099	3
Lateral Panel With Black is Green Logo	MPVR10664	0099	1
Lid for 22 l Bucket Black	SECC70043		2
Lid For Bag Support	MPVR94837	0013	1
Mop Support	MPVR94835	0099	1
Pair of Brix Lock Keys	CHVR00056		1
Pedal	MPVR94676	0006	1
Round Cover For Base Ø 25 mm	MPVR94871	0099	2
Round Cover For Base Ø 30 mm	MPVR94704	0006	1
Rubber Handle Holder Complete - For Brix PT Version	PMVR06633	0013	1
Set Of 1 Upper Plate With Brix/IPC Logo, 1 Slot Covering Cap And 1 Slot Covering Cap With "Made in Italy"	MPVR94920	0099	1
Set Of 6 Covers For Aluminum Supports And Wrench	MPVR94818	0006	1
Set Of Handle, Tools And Safety Sign Holders	MPVR94819	0006	1
Shock Absorber for 120 l Lid	MPVR10546		1
Small Countertop	MPVR94850	0099	2
Transparent Lid For Countertop Complete With Plastic Lock	MPVR94841	0670	1
Upper Support For 22 l Bucket	COME00267	0008	1
Pair of Bag Support Holders Fixed	PMVR06722	0013	1
Pair of Supports for Bag Support Holders	PMVR06724	0013	1

ECOMIX

BLACK IS GREEN™

COMPONENTES & ACCESSORIES

25 LT. BASE FOR ECOMIX

CODE
SECC00068 - 0099

UNIT PRICE
€ 19,50



RUBBER WHEEL Ø 80 MM (NYLON FORK)

CODE
RTRT00566 - 0006

UNIT PRICE
€ 6,50



DAM

BLACK IS GREEN™

COMPONENTES & ACCESSORIES

BUMPER 90X30 MM

CODE
MPVR94574 - 0006

UNIT PRICE
€ 1,02



NEW LINE / STRONG WRINGER

CODE
STRI00030 - IPGX

UNIT PRICE
€ 54,90



BASE FOR DAM 2X15 LT.

CODE
SECC00065 - 0099

UNIT PRICE
€ 20,70



RUBBER WHEEL Ø 80 MM (METAL FORK)

CODE
RTRT99663

UNIT PRICE
€ 6,50



BUMPER 90X30 MM

CODE
MPVR94574 - 0006

UNIT PRICE
€ 1,02



INSERT FOR WRINGER + HANDLE HOLDER

CODE
MPVR04764 - 0006

UNIT PRICE
€ 16,05



BACK SUPPORT BLACK PAINTED FOR TRAY

CODE
LAFN99726

UNIT PRICE
€ 17,50



FRONT SUPPORT BLACK PAINTED FOR TRAY

CODE
LAFN99727

UNIT PRICE
€ 17,50



POLYPROPYLENE TRAY FOR SIDE HANDLE

CODE
MPVR94619 - 0006

UNIT PRICE
€ 7,45



NEW LINE / STRONG WRINGER

CODE
STRI00035 - IPGX

UNIT PRICE
€ 54,90



MOUSSE SHIM FOR NEW LINE / STRONG WRINGER

CODE
LAMU00005

UNIT PRICE
€ 8,85



BIS

BLACK IS GREEN™

COMPONENTES & ACCESSORIES

BASE WITH WHEELS

CODE
PMVR95608 - 0099

UNIT PRICE
€ 35,65



RUBBER WHEEL Ø 80 MM (METAL FORK)

CODE
RTRT99663

UNIT PRICE
€ 6,50



HOLDER FOR HANDLE

CODE
MPVR94778 - 0006

UNIT PRICE
€ 3,35



HANDLE COMPLETE GREY PAINTED

CODE STANDARD
PMLA96088

UNIT PRICE
€ 15,45

CODE WITH HOOKS
FOR TRAY
MPVR99846

UNIT PRICE
€ 18,80



BUMPER 90X30 MM

CODE
MPVR94574 - 0006

UNIT PRICE
€ 1,02



15 LT. BUCKET BLACK IS GREEN™

CODE
SECC00055

● 0599 ● 0299

UNIT PRICE
€ 9,95



25 LT. BUCKET BLACK IS GREEN™

CODE
SECC00057

● 0599 ● 0299

UNIT PRICE
€ 9,95



ROUND LINKING PINS FOR WRINGER SUPPORT

CODE
MPVR94647 - 0006

UNIT PRICE
€ 0,51



NEW LINE / STRONG WRINGER

CODE
STRI00030 - IPGX

UNIT PRICE
€ 54,90



POLYPROPYLENE FIXING KIT FOR HANDLE

CODE
KTRI05247 - 0006

UNIT PRICE
€ 4,50



LINKING PINS FOR HANDLE

CODE
MPVR94638 - 0006

UNIT PRICE
€ 0,51



TRAY FOR HANDLE WITH HOOKS

CODE
PMVR95609

UNIT PRICE
€ 8,75



TRAY FOR HANDLE

CODE
MPVR94645

UNIT PRICE
€ 6,40



PLASTIC COVER FOR DOVETAIL JOINT

CODE
MPVR94644 - 0006

UNIT PRICE
€ 0,72



REVOLUTION BLACK IS GREEN™ COMPONENTES & ACCESSORIES

ERGONOMIC BAG SUPPORT COMPLETE

120 LT.

CODE
MPVR94522 - 0099
UNIT PRICE
€ 9,80



2X70 LT.

CODE
PMVR95604 - 0099
UNIT PRICE
€ 11,85

3X40 LT.

CODE
PMVR06449 - 0099
UNIT PRICE
€ 13,90

NEW LINE / STRONG WRINGER

CODE
STR100030 - IPGX

UNIT PRICE
€ 54,90



6 LT. BUCKET BLACK IS GREEN™

CODE BUCKET
SECC00056

● 0599 ● 0299

UNIT PRICE
€ 4,50

CODE LID
MPVR10854 - 0008

UNIT PRICE
€ 5,90



15 LT. BUCKET BLACK IS GREEN™

CODE
SECC00055

● 0599 ● 0299

UNIT PRICE
€ 9,95



CENTRAL BASE REVOLUTION WITHOUT WHEELS

CODE
MPVR94622 - 0099

UNIT PRICE
€ 21,45



CYLINDRICAL SUPPORT TYPE COMPACT

CODE
LAFN99623

UNIT PRICE
€ 19,90



LEVER HOLDING BAG

CODE
MPVR94633 - 0006

UNIT PRICE
€ 1,02



RILSAN WRINGER SUPPORT

CODE
PMLA96082 - 0006

UNIT PRICE
€ 16,45



6 LT. BUCKET HOLDER WITH BRACKET

CODE
PMVR95756

UNIT PRICE
€ 8,85



120 LT. PLASTICIZED BAG WITH FRONTAL OPENING ZIP

CODE
SACC00034 - 0006

UNIT PRICE
€ 47,40



BAR HOLDIN FOR BAG SUPPORT WITH DOVETAIL JOINT

CODE
MPVR94773 - 0099

UNIT PRICE
€ 6,00



REINFORCING BARS FOR BAG SUPPORT

CODE
MPVR94631 - 0099

UNIT PRICE
€ 4,50



SIDE SUPPORT FOR MOP

CODE
MPVR94599 - 0099

UNIT PRICE
€ 4,30



120 LT. LID

CODE
MPVR94593 - 0006

UNIT PRICE
€ 10,50



RUBBER WHEEL Ø 100 MM (METAL FORK)

CODE
RTRT00725

UNIT PRICE
€ 9,85



HANDLE HOLDER COMPLETE

CODE
PMVR95640 - 0006

UNIT PRICE
€ 3,70



ROUND COVER FOR BASE Ø 30 MM

CODE
MPVR94704 - 0006

UNIT PRICE
€ 0,51



CLIP FOR HANDLE NEW LINE / STRONG WRINGER

CODE
MPVR94749 - 0006

UNIT PRICE
€ 1,02



CLIP FOR SUPPORT FOR BAG

CODE
MPVR94752 - 0006

UNIT PRICE
€ 0,82



PLASTIC COVER FOR DOVETAIL JOINT

CODE
MPVR94584 - 0006

UNIT PRICE
€ 1,02



BRIX

BLACK IS GREEN™

COMPONENTES & ACCESSORIES

STRUCTURE

BASE COMPLETE

WITH 4 RUBBER WHEELS Ø100 MM (METAL FORK)

CODE
PMVR95672 - 0099

UNIT PRICE
€ 74,00



BASE COMPLETE

WITH 4 RUBBER WHEELS Ø100 MM (METAL FORK) AND 2 BRAKES

CODE
PMVR95675 - 0099

UNIT PRICE
€ 80,70



BASE COMPLETE

WITH 4 RUBBER WHEELS Ø 125 MM (NYLON FORK) WITH 1 BRAKE AND 4 BUMPERS

CODE
PMVR95678 - 0099

UNIT PRICE
€ 113,80



BASE COMPLETE

WITH 4 RUBBER WHEELS Ø 125 MM (NYLON FORK) AND 4 BUMPERS

CODE
PMVR95674 - 0099

UNIT PRICE
€ 109,30



BASE COMPLETE

WITH 4 RUBBER WHEELS Ø125 MM (NYLON FORK) WITH BRAKES AND 4 BUMPERS

CODE
PMVR95671 - 0099

UNIT PRICE
€ 116,00



BASE COMPLETE

WITH 4 RUBBER WHEELS Ø 150 MM

CODE
PMVR95676 - 0099

UNIT PRICE
€ 228,30



METAL WHEEL Ø 80 MM

CODE
RTRT99663

UNIT PRICE
€ 6,50



RUBBER WHEEL Ø 100 MM (METAL FORK)

CODE
RTRT00557

UNIT PRICE
€ 9,85



RUBBER WHEEL Ø 100 MM WITH BRAKE (METAL FORK)

CODE
RTRT99629

UNIT PRICE
€ 13,10



DELUXE RUBBER WHEEL Ø 125 MM (METAL FORK)

CODE
RTRT00687

UNIT PRICE
€ 21,75



DELUXE RUBBER WHEEL Ø 125 WITH BRAKE (METAL FORK)

CODE
RTRT00688

UNIT PRICE
€ 26,20



RUBBER WHEEL Ø 125 MM (NYLON FORK)

CODE
RTRT00756

UNIT PRICE
€ 17,50



RUBBER WHEEL Ø 125 MM WITH BRAKE (NYLON FORK)

CODE
RTRT00757

UNIT PRICE
€ 20,90



RUBBER WHEEL Ø 150 MM (NYLON FORK)

CODE
RTRT00784

UNIT PRICE
€ 32,30



RUBBER WHEEL Ø 300 MM

CODE
RTRT00671

UNIT PRICE
€ 29,65



ALUMINUM CYLINDRICAL SUPPORT 357 MM FOR BRIX LIGHT

CODE
PRAL00115

UNIT PRICE
€ 1,83



ALUMINUM CYLINDRICAL SUPPORT 388 MM FOR BRIX LIGHT

CODE
PRAL00116

UNIT PRICE
€ 1,83



BRACING TUBE FOR BRIX LIGHT

CODE
PRAL00114 - 0008

UNIT PRICE
€ 16,15



WHEEL CAP Ø 300 MM

CODE
MPVR11980 - 0013
UNIT PRICE
€ 0,51



WHEEL SUPPORT Ø 300 MM

CODE
COME00339
UNIT PRICE
€ 30,70



FIXING JUNCTION

FOR WHEELS FOR COMPACT TROLLEYS

CODE
MPVR04773 - 0013
UNIT PRICE
€ 1,45



ADAPTATOR ANTIROTATION COMPACT

CODE
MPVR04775 - 0013
UNIT PRICE
€ 0,41



BUMPER FOR WHEEL

CODE
MPVR94855 - 0013
UNIT PRICE
€ 1,83



ROUND COVER FOR BASE Ø 25 MM

CODE
MPVR94871 - 0099
UNIT PRICE
€ 0,41



ROUND COVER (FOR BASE FOR BAG)

CODE
MPVR94870 - 0099
UNIT PRICE
€ 1,02



ROUND COVER FOR BASE Ø 30 MM

CODE
MPVR94704 - 0006
UNIT PRICE
€ 0,51



ALUMINUM CYLINDRICAL SUPPORT 803 MM TYPE 1

CODE
PRAL00081 - 0008
UNIT PRICE
€ 9,20



LATERAL COVER FOR ALUMINUM CYLINDRICAL SUPPORT BLACK

CODE standard version
MPVR04769 - 0099
CODE short version
MPVR11876 - 0099
UNIT PRICE
€ 3,35



CENTRAL COVER FOR ALUMINUM CYLINDRICAL SUPPORT BLACK

CODE
MPVR04778 - 0099
UNIT PRICE
€ 3,35



LATERAL COVER WITH BLACK HANDLE HOLDER

CODE
PMVR01538 - 0099
UNIT PRICE
€ 8,75



LATERAL PANEL NEUTRAL

CODE
MPVR94843 - 0099
UNIT PRICE
€ 11,00



LATERAL PANEL WITH BRIX LOGO

CODE
MPVR94842 - 0099
UNIT PRICE
€ 11,00



LATERAL PANEL WITH BLACK IS GREEN LOGO

CODE
MPVR10664 - 0099
UNIT PRICE
€ 11,00



SET OF 4 COVERS FOR SIDE PANEL

CODE
MPVR94820 - 0013
UNIT PRICE
€ 4,40



COVER FOR LATERAL PANEL

CODE
MPVR94861 - 0013
UNIT PRICE
€ 1,02



LARGE COUNTERTOP

CODE
MPVR94849 - 0099
UNIT PRICE
€ 24,90



SMALL COUNTERTOP

CODE
MPVR94850 - 0099
UNIT PRICE
€ 17,00



DOVETAIL INSERT

CODE
MPVR94858 - 0099
UNIT PRICE
€ 0,51



DOVETAIL INSERT WITH SLOT

CODE
MPVR04771 - 0013
UNIT PRICE
€ 0,51



DOVETAIL INSERT WITH 4 HOLES

CODE
MPVR04772 - 0013
UNIT PRICE
€ 0,51



DOVETAIL HOOKING

CODE
MPVR94680 - 0006
UNIT PRICE
€ 1,32



SET OF 6 COVERS FOR ALUMINUM SUPPORTS AND WRENCH

CODE
MPVR94818 - 0006
UNIT PRICE
€ 2,03



SET OF

1 UPPER PLATE WITH BRIX LOGO, 1 SLOT COVERING CAP AND 1 SLOT COVERING CAP WITH "MADE IN ITALY"

CODE
MPVR94823 - 0099

UNIT PRICE
€ 1,58



KIT COMPLETE

1 UPPER PLATE BRIX AND IPC LOGO, 1 SLOT COVERING CAP AND 1 SLOT COVERING CAP WITH "MADE IN ITALY"

CODE
MPVR94920 - 0099

UNIT PRICE
€ 1,58



SET OF

1 UPPER PLATE WITH BRIX LOGO, 3 SLOT COVERING CAP AND 1 SLOT COVERING CAP WITH "MADE IN ITALY"

CODE
MPVR94828 - 0099

UNIT PRICE
€ 1,80



UPPER PLATE

WITH BRIX AND IPC LOGO

CODE
MPVR04776 - 0099

UNIT PRICE
€ 0,56



UPPER PLATE

WITH BRIX LOGO

CODE
MPVR94873 - 0099

UNIT PRICE
€ 0,56



SLOT COVERING CAP

WITH "MADE IN ITALY"

CODE
MPVR94856 - 0099

UNIT PRICE
€ 0,51



SLOT COVERING CAP

CODE
MPVR94857 - 0099

UNIT PRICE
€ 0,51



BOTTOM INSERT

FOR COUNTERTOP

CODE
MPVR94839 - 0099

UNIT PRICE
€ 4,00



FLAT INSERT

FOR COUNTERTOP

CODE
MPVR94851 - 0099

UNIT PRICE
€ 4,60



BLACK LID

FOR COUNTERTOP COMPLETE WITH METAL KEY LOCK

CODE with key
MPVR04794 - 0013

UNIT PRICE
€ 11,90

CODE without key
MPVR94838 - 0013

UNIT PRICE
€ 10,80



BLACK LID

FOR COUNTERTOP COMPLETE WITH PLASTIC LOCK

CODE
MPVR94841 - 0613

UNIT PRICE
€ 7,45



TRANSPARENT LID

FOR COUNTERTOP COMPLETE WITH METAL KEY LOCK

CODE with key
MPVR04794 - 0070

UNIT PRICE
€ 15,95

CODE without key
MPVR94838 - 0070

UNIT PRICE
€ 14,85



TRANSPARENT LID

FOR COUNTERTOP COMPLETE WITH PLASTIC LOCK

CODE
MPVR94841 - 0670

UNIT PRICE
€ 8,55



LOCK COMPLETE

FOR LID

CODE
CHVR00057

UNIT PRICE
€ 8,25



3 HINGES

(DOUBLE VERSION)

CODE
MPVR94821 - 0008

UNIT PRICE
€ 1,02



3 HINGES

(SINGLE VERSION)

CODE
MPVR94822 - 0008

UNIT PRICE
€ 1,02



DOOR COMPLETE

WITH PLASTIC LOCK

CODE
MPVR94847

UNIT PRICE
€ 7,85

DOOR COMPLETE

WITH METAL KEY LOCK

CODE con chiave
MPVR04779

UNIT PRICE
€ 16,25

CODE senza chiave
MPVR94848

UNIT PRICE
€ 14,95

● 0599 ● 0299
● 0499 ● 0999



COVER HANDLE

FOR DOORS

CODE
MPVR94891

UNIT PRICE
€ 1,53

● 0005 ● 0002
● 0004 ● 0009



40 LT. BIG DRAWER

CODE
MPVR11495 - 0099

UNIT PRICE
€ 64,60



DIVIDER FOR 40 LT. BRIX BIG DRAWER

CODE
MPVR11774 - 0013

UNIT PRICE
€ 31,70



DRAWER COMPLETE

WITH FRONTAL COLORED PANELL

CODE
with key
PMVR01547

UNIT PRICE
€ 32,80

CODE
with plastic lock
PMVR06324

UNIT PRICE
€ 25,00

CODE
without closure
PMVR95685

UNIT PRICE
€ 24,90

● 0599 ● 0299
● 0499 ● 0999
● 0699 ● 0099

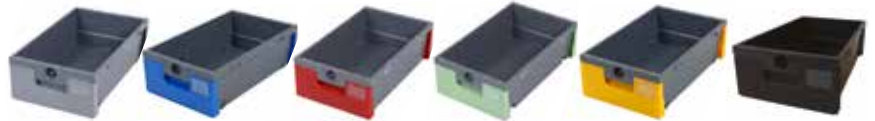

LOCK COMPLETE

FOR DOORS & DRAWERS

CODE
CHVR00058

UNIT PRICE
€ 8,25

METAL KEY PAIR

CODE
CHVR00056

UNIT PRICE
€ 1,12



PRE-IMPREGANTION GRID

FOR BRIX DRAWER

CODE
LAFN11599

UNIT PRICE
€ 30,00



UPPER SUPPORT

FOR BRIX LIGHT

CODE
MPVR10680 - 0008

UNIT PRICE
€ 12,40



ROUND COVER

FOR BRIX LIGHT BRACING TUBE

CODE
MPVR10849 - 0008

UNIT PRICE
€ 0,72



LOWER SUPPORT

FOR BRIX LIGHT

CODE
MPVR10853 - 0008

UNIT PRICE
€ 12,40



INSERT

FOR CYLINDRICAL SUPPORT AND BRACING TUBE FOR BRIX LIGHT

CODE
MPVR10681 - 0008

UNIT PRICE
€ 0,72



WASTE COLLECTION

BASE FOR BAG

WITH 2 WHEEL SUPPORTS, 2 WHEELS Ø 80 MM AND PEDAL SUPPORT

CODE
PMVR95681 - 0099

UNIT PRICE
€ 38,00



BASE FOR BAG

WITH 2 WHEEL SUPPORTS AND 2 WHEELS Ø 80 MM

CODE
PMVR01539 - 0099

UNIT PRICE
€ 32,80



BASE FOR BAG

CODE
PMVR95682 - 0099

UNIT PRICE
€ 19,80



SUPPORT COMPLETE

WITH WHEEL Ø 80 MM

CODE
PMVR95687 - 0013

UNIT PRICE
€ 13,10



LOWER ROD

FOR MOP SUPPORT

CODE
PMVR06490 - 0013

UNIT PRICE
€ 14,35



BASE REGGISCOPA

CODE
MPVR94835 - 0099

UNIT PRICE
€ 3,70



ROUND COVER

(FOR BASE FOR BAG)

CODE
MPVR94870 - 0099

UNIT PRICE
€ 1,02



BAR FOR PEDAL

CODE
PMVR06751 - 0006

UNIT PRICE
€ 5,50



PEDAL SUPPORT

CODE
MPVR94879 - 0099

UNIT PRICE
€ 5,20



PEDAL

CODE
MPVR94676 - 0006
UNIT PRICE
€ 5,80



PAIR OF SUPPORTS FOR BAG SUPPORT HOLDER

CODE
PMVR06724 - 0013
UNIT PRICE
€ 7,00



PAIR OF BAG SUPPORT HOLDERS FIXED

CODE
PMVR06722 - 0013
UNIT PRICE
€ 13,30



120 LT. BAG SUPPORT WITH BUMPERS

CODE
MPVR94816 - 0099
UNIT PRICE
€ 17,50



2X70 LT. BAG SUPPORT WITH BUMPERS

CODE
PMVR95684 - 0099
UNIT PRICE
€ 21,85



3X40 LT. BAG SUPPORT WITH BUMPERS

CODE
PMVR06290 - 0099
UNIT PRICE
€ 25,20

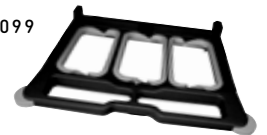

SHOCK ABSORBER FOR BRIX LID

CODE
MPVR10546
UNIT PRICE
€ 2,95



DIVIDER FOR BAG SUPPORT (HOLDING 2X70 LT. BAG)

CODE
MPVR94866 - 0099
UNIT PRICE
€ 2,03



LEVER HOLDING BAG

CODE
MPVR94633 - 0006
UNIT PRICE
€ 1,02



LEVER HOLDING BAG COUPLE FOR TRIPLE WASTE COLLECTION

CODE
MPVR10649 - 0006
UNIT PRICE
€ 3,35



LID FOR BAG SUPPORT

CODE
MPVR94837 - 0013
UNIT PRICE
€ 9,95



DOCUMENT HOLDER

CODE
MPVR10647
UNIT PRICE
€ 14,25



UPPER ROD FOR HOLDERS

CODE
PMVR06435 - 0013
UNIT PRICE
€ 14,85



SET OF HANDLE, TOOLS AND SAFETY SIGN HOLDERS

CODE
MPVR94819 - 0006
UNIT PRICE
€ 4,50



HOLDER FOR TOOLS COMPLETE

CODE
PMVR95638 - 0006
UNIT PRICE
€ 1,63



HANDLE HOLDER COMPLETE

CODE
PMVR95637 - 0006
UNIT PRICE
€ 1,12



SAFETY SIGN HOLDER COMPLETE

CODE
PMVR95639 - 0006
UNIT PRICE
€ 1,63



RUBBER HANDLE HOLDER COMPLETE

CODE
PMVR01545 - 0006
UNIT PRICE
€ 6,50



FOR BRIX PT VERSION	MAXI VERSION
CODE PMVR06633 - 0013	CODE PMVR06443 - 0006
UNIT PRICE € 6,50	UNIT PRICE € 7,75

120 LT. GREY BAG WITH FRONTAL ZIPPER

CODE
SACC00024 - 0006
UNIT PRICE
€ 43,05



70 LT. BAG WITH STRING

CODE
SACC00036
● 0005 ● 0002
UNIT PRICE
€ 34,50



FOLDING KIT 120 LT BAG SUPPORT

CODE
KTRI06066 - 0099
UNIT PRICE
€ 96,50



**40 LT. BAG
WITH STRING**

CODE
SACC00061

- 0005 ● 0002
- 0003 ● 0004

UNIT PRICE
€ 32,00



**35 LT. BAG
WITH STRING**

CODE
SACC00038

- 0025 ● 0002

UNIT PRICE
€ 31,90



**15 LT. BAG
WITH STRING FOR BRIX MICRO**

CODE
SACC00059

- 0005 ● 0002

UNIT PRICE
€ 26,90

**EXTRACTIBLE SUPPORT
FOR 2x15 LT. BAGS**

CODE KIT
COME00314 - 0008

UNIT PRICE
€ 59,20



**90 LT. NET
FOR MOP WASHING**

CODE
SACC00002

- 0501 ● 0201

UNIT PRICE
€ 11,80



**70 LT. NET
FOR MOP WASHING**

CODE
SACC00001

- 0001

UNIT PRICE
€ 8,35



CODE
SACC00009

- 1501 ● 0201
- 0301 ● 0401

UNIT PRICE
€ 8,35

**35 LT. NET
FOR MOP WASHING**

CODE
SACC00017 - 0201

UNIT PRICE
€ 9,75



**SET OF 4 HOOKS FOR NET
FOR MOP WASHING SUITABLE FOR 120 LT. OR
2X70 LT. BAG SUPPORT**

CODE
KTRI05213

UNIT PRICE
€ 6,00



SUITABLE FOR 3X40 LT.
BAG SUPPORT

CODE
KTRI05214

UNIT PRICE
€ 6,00



**CYLINDRICAL SUPPORT
FOR ADJUSTABLE HANDLE**

CODE
PRAL00119 - 0008

UNIT PRICE
€ 9,10



PUSHING SYSTEMS

SHORT VERSION KIT

WITH 2 CYLINDRICAL SUPPORT

CODE
PMVR06377

UNIT PRICE
€ 96,90



LONG VERSION KIT

WITH 2 CYLINDRICAL SUPPORT

CODE
PMVR06378

UNIT PRICE
€ 102,30



PUSHING HANDLE
FOR SMALL SHELF

CODE
KTRI04784 - 0099
UNIT PRICE
€ 12,40



PUSHING HANDLE

CODE
MPVR94594 - 0099
UNIT PRICE
€ 5,60



PUSHING HANDLE COMPLETE
WITH BUMPERS

CODE
MPVR94854 - 0013
UNIT PRICE
€ 15,50



9 LT. TRAY
FOR MOPS/TOOLS (FITS THE PUSHING HANDLE)

CODE
MPVR94836 - 0099
UNIT PRICE
€ 6,50



LID FOR 9 LT. TRAY
WITH HINGES

CODE
MPVR94840 - 0099
UNIT PRICE
€ 7,15



METAL SUPPORTS
FOR 9 L TRAY

CODE
COME00329
UNIT PRICE
€ 30,25



PRE-IMPREGRATION GRID
FOR 9 LT. TRAY

CODE
LAFN11596
UNIT PRICE
€ 22,50



WASHING & DUSTING SYSTEMS

KINETIC PLUS
WRINGER

CODE
STRI00072

● IP13

UNIT PRICE
€ 70,00



NEW LINE / STRONG
WRINGER

CODE
STRI00030 - IPGX

UNIT PRICE
€ 54,90



SPEED / BOOK
WRINGER

CODE
STRI00003 - 0099

UNIT PRICE
€ 49,50



ROLLER / RULLY
WRINGER

CODE
STRI00007 - 0099

UNIT PRICE
€ 98,90



METAL WRINGER SUPPORT
COMPLETE

CODE standard
PMLA96093 - 0008

UNIT PRICE
€ 15,45

CODE for base for bag
COME00310 - 0008

UNIT PRICE
€ 37,70



15 LT. BUCKET
BLACK IS GREEN™

CODE
SECC00055

● 0599 ● 0299

UNIT PRICE
€ 9,95



6 LT. BUCKET
BLACK IS GREEN™

CODE BUCKET
SECC00056

● 0599 ● 0299

● 0999 ● 0499

UNIT PRICE
€ 4,50

CODE LID
MPVR10854

● 0008

UNIT PRICE
€ 5,90



6 LT. BUCKET SWIVEL SUPPORTS FOR BRIX*

CODE KIT (DX+SX) PMVR06423 - 0008
UNIT PRICE € 29,65

CODE DX COME00334 - 0008
UNIT PRICE € 14,85

CODE SX COME00335 - 0008
UNIT PRICE € 14,85

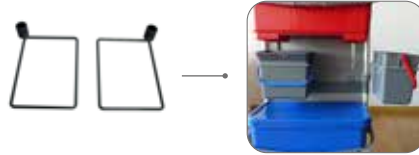

RUBBER INSERT FOR 6 LT. BUCKETS

CODE LAMU00021

UNIT PRICE € 8,95



KIT RUBBER INSERT WITH TWO 6 LT. BUCKET BLACK IS GREEN™

CODE KTRI04843

UNIT PRICE € 17,70

HOLDER FOR 6 LT. BUCKET OR 35 LT. BAG

CODE PMVR95688 - 0006

UNIT PRICE € 7,30



PRE-TREAT SYSTEMS

22 LT. BUCKET BLACK IS GREEN™ BLUE HANDLE

CODE SECC70027 - NNNB

UNIT PRICE € 13,20



22 LT. BUCKET BLACK IS GREEN™ RED HANDLE

CODE SECC70027 - NNNR

UNIT PRICE € 13,20



LID FOR 22 LT. BUCKET

CODE SECC70043

UNIT PRICE € 6,80



MOPS DIVIDER FOR 22 LT. BUCKET

CODE MPVR11725

UNIT PRICE € 39,40

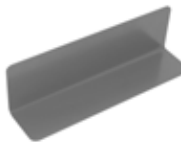

PRE-IMPREGRATION GRID FOR 22 LT. TRAY

CODE LAFN11597

UNIT PRICE € 30,00



MOP DIVIDER FOR 22 LT. BUCKET

CODE COME00267 - 0008

UNIT PRICE € 33,00



LOWER SUPPORT FOR 22 LT. BUCKET

CODE COME00268 - 0008

UNIT PRICE € 56,00



HANGING HOOK FOR 22 LT. BUCKET

CODE PMLA96095 - 0008

UNIT PRICE € 10,50



GLOVES BOX HOLDER

NEW
CODE COME00385
UNIT PRICE € 15,00



SUPPORT FOR 9 LT. TRAY

NEW
CODE PMVR06812 - 0081
UNIT PRICE € 27,00



GEL BOTTLE HOLDER

NEW
CODE KTRI06260 - 0081
UNIT PRICE € 27,50



PT

The new PT (Pre-Treated) trolleys range, made in recycled plastic in the new grey colour (RAL 7044), has been specifically designed to combine ease of use and attention to the operators' safety.

The two buckets dedicated to the preparation and transportation of the mop detergent solution impregnation in one and the storage of dirty mops in the other, permit to avoid all risks of contamination.

Designed to be managed in both narrow and large areas in the respect of sanitary protocols. Equipped with dedicated accessories for operator safety, glove holders and liquid dispenser easy to reach for frequent hand protection.

PT 01

CODE Assembled
CARR03173 - IP98

UNIT PRICE
€ 415,00

CODE Disassembled
CARR03166 - IP98

UNIT PRICE
€ 388,00



DIMENSION
mm 900 x 680 x 1220 h

WEIGHT
19,55 kg

PT 02

CODE Assembled
CARR03172

UNIT PRICE
€ 832,00

CODE Disassembled
CARR03163

UNIT PRICE
€ 805,00



DIMENSION
mm 1120 x 660 x 1185 h

WEIGHT
37,80 kg

PT 03

CODE Assembled
CARR03174

UNIT PRICE
€ 685,00

CODE Disassembled
CARR03165

UNIT PRICE
€ 658,00



DIMENSION
mm 1230 x 660 x 1185 h

WEIGHT
32,80 kg

PT 04

CODE Assembled
CARR03159

UNIT PRICE
€ 730,00 *

CODE Disassembled
CARR03171

UNIT PRICE
€ 757,00 *



DIMENSION
mm 1250 x 810 x 1185 h

WEIGHT
32,00 kg

* Generatore di vapore non incluso



Compatible steam generators (not included)

SG-10 S 5007 M	GNVA40037	€ 1.375,00
SG-10 S 6008 M	GNVA40038	€ 1.650,00
SG-50 S 5008 M	GNVA40070	€ 3.810,00
SG-50 S 5010 M	GNVA40071	€ 3.890,00

CLEANING
TROLLEYS
RANGE /
BRIX

MANY MODULES, ENDLESS VERSIONS

BAG SUPPORT

120 l, 2x70 l
or 3x40 l
bag support with lid.



9 LT. TRAY WITH LID

Tray for tools/mops.



COLUMNS

Available in 2 columns (2 or 3 shelves), 1 column (2 or 3 shelves) or Light version.



PT SYSTEM

Double bucket 22 l red & blue for washing and disinfection.



DOUBLE BUCKET WITH WRINGER

Double bucket 2x15 l with 3 different wringers available.



SDS™ SYSTEM

SDS™ System for the instant mop impregnation. Suitable for the cleaning of medium-high risk of bacterial contamination environments.

Main feature

MODULARITY



Each Brix can be customized and adapted to meet the different user's needs. You can choose between 4 basic structures adding afterward different modules. In a few minutes you can configure your Brix!

Details

01

- **NO BRIX IS THE SAME AS ANOTHER!** Each Brix can be customised by different components, colors, logos, ecc.
- **BRIX IS A TRULY MODERN SOLUTION** because it can be configured by the end user.
- **NO SPECIFIC SKILLS OR SPECIAL TOOLS** are required to assemble your Brix

Trolleys

02

BRIX TROLLEYS RANGE

WASHING TROLLEYS



- **PRACTICAL AND COMPACT**
- **IDEAL FOR GENERAL CLEANING** of small and medium surfaces (schools, canteens, gyms and public areas)

HYGIENE & DISINFECTION TROLLEYS



- **BRIX HEALTHCARE:** designed for hospital
- **BRIX PT:** the standard model for the pre-treated impregnation cleaning methode
- **BRIX SDS:** the exclusive IPC solution for instant mops impregnation

WASTE COLLECTION TROLLEYS



- **OPTIONS FOR RECYCLING AND GREEN CLEANING AVAILABLE**
- **HIGH CAPACITY:** 6 bag supports for a total capacity of 440 litres
- Ideal for communities, industries and horeca

HOTEL TROLLEYS



- **ROBUST AND VERSATILE:** 3 shelves for linen collection and drawers for consumables storage
- **AVAILABLE IN TWO SIZES** for large (up to 14 rooms) and smaller hotels (up to 8 rooms)

BRIX MICRO

CODE
CARR01953

UNIT PRICE
€ 537,50



←
**EXTRACTABLE
INTERNAL BAG SUPPORT**

SIZE
mm 720 x 520 x 1220 h



COMPOSITION

	CODE	DIGIT	QUANTITY
4 Covers for lateral panel	MPVR94820	0008	2
6 l Bucket grey - blue handle	SECC00056	0508	1
6 l Bucket grey - red handle	SECC00056	0208	1
Adaptator antirotation compact	MPVR04775	0008	4
Aluminum cylindrical support 803 mm type 1	PRAL00081	0008	4
Bottom insert for countertop	MPVR94839	0008	3
Bumper for wheel	MPVR94855	0006	4
Door complete with plastic lock - green handle	MPVR94847	0906	2
Dovetail insert	MPVR94858	0008	8
Dovetail insert with slot	MPVR04771	0008	4
Drawer complete without closure - green frontal panel	PMVR95685	0908	2
Extractible support for 15 l bags	COME00314	0008	1
Fixing junction for wheels for compact trolleys	MPVR04773	0008	4
Flat insert for countertop	MPVR94851	0008	2
Grey lid for countertop complete with plastic lock	MPVR94841	0608	1
Hinges (double version)	MPVR94821	0008	2
Lateral neutral panel	MPVR94843	0008	3
Lateral panel with Brix logo	MPVR94842	0008	1
Lever holding bag	MPVR94633	0008	2
Pushing handle	MPVR94594	0006	1
Rubber insert for 6 l buckets	LAMU00021		1
Rubber wheel (nylon fork) ø 125 mm	RTRT00572	0006	2
Rubber wheel (nylon fork) ø 125 mm with brake	RTRT00570	0006	2
Safety sign holder complete	PMVR95639	0008	1
Set of 6 covers for aluminum support and wrench	MPVR94818	0006	1
Set of handle, tools and safety sign holders	MPVR94819	0008	1
Slot covering cap with "Made in Italy"	MPVR94856	0008	1
Small countertop	MPVR94850	0008	2
Small countertop with hooks for pushing handle	MPVR10673	0008	1
Soft lateral cover for aluminum cylindrical support light grey	MPVR94860	0006	6
Upper plate with IPC + Brix logo	MPVR04776	0008	1

BRIX COMPACT

WITH NEW LINE WRINGER
 CODE
CARR01293

UNIT PRICE
€ 570,80

WITH KINETIC WRINGER
 CODE
CARR51293

UNIT PRICE
585,90€

SIZE
 mm 845 x 680 x 1220 h



COMPOSITION

	CODE	DIGIT	QUANTITY
15 l bucket - green	SECC00055	0609	1
15 l bucket - silver	SECC00055	0620	1
4 Covers for lateral panel	MPVR94820	0008	2
6 l bucket grey - blue handle	SECC00056	0508	1
6 l bucket grey - red handle	SECC00056	0208	1
Adaptator antirotation compact	MPVR04775	0008	2
Aluminum cylindrical support 803 mm type 1	PRAL00081	0008	4
Base for bag with 2 wheel supports and 2 wheels ø 80 mm	PMVR01539	0008	1
Bottom insert for countertop	MPVR94839	0008	4
Door complete with plastic lock - green handle	MPVR94847	0906	2
Dovetail insert	MPVR94858	0008	6
Dovetail insert with slot	MPVR04771	0008	2
Drawer complete without closure - green frontal panel	PMVR95685	0908	2
Fixing junction for wheels for compact trolleys	MPVR04773	0008	4
Flat insert for countertop	MPVR94851	0008	2
Grey lid for countertop complete with plastic lock	MPVR94841	0608	1
Hard lateral cover with handle holder for aluminum cylindrical support light grey	PMVR01538	0006	2
Hinges (double version)	MPVR94821	0008	2
Holder for tools complete	PMVR95638	0008	1
Lateral neutral panel	MPVR94843	0008	3
Lateral panel with Brix logo	MPVR94842	0008	1
Metal wringer support complete with plastic inserts for base for bag	COME00310	0008	1
Mop support	MPVR94835	0008	1
New Line/Strong wringer - green	STRI00030	IP09	1
Pushing handle complete with hooks for small countertop	KTRI04784	0006	1
Rubber insert for 6 l buckets	LAMU00021		1
Rubber wheel (nylon fork) ø 125 mm	RTRT00572	0006	4
Safety sign holder complete	PMVR95639	0008	1
Set of 6 covers for aluminum support and wrench	MPVR94818	0006	1
Slot covering cap with "Made in Italy"	MPVR94856	0008	1
Small countertop	MPVR94850	0008	3
Soft lateral cover for aluminum cylindrical support light grey	MPVR94860	0006	4
Transparent lid for countertop complete with plastic lock	MPVR94841	0670	1
Upper plate with IPC + Brix logo	MPVR04776	0008	1

BRIX SCHOOL SUITE

WITH NEW LINE WRINGER
 CODE Assembled
CARR00567 - IP08646AST

UNIT PRICE
€ 609,60

CODE Disassembled
CARR00567 - IP08646SST

UNIT PRICE
€ 582,70

CON STRIZZATRORE KINETIC
 CODE Assembled
CARR50567 - IP08827AST

UNIT PRICE
€ 624,70

CODE Disassembled
CARR50567 - IP08827SST

UNIT PRICE
€ 597,80

WITH FOLDING KIT
 CODE Assembled
CARR03093 - IP08

UNIT PRICE
€ 613,90



DIMENSION
 mm 1245 x 680 x 1040 h



COMPOSITION

BRIX SCHOOL PREMIUM

WITH NEW LINE WRINGER
 CODE Assembled
CARR00567 - IP08648AST

UNIT PRICE
€ 516,00

CODE Disassembled
CARR00567 - IP08648SST

UNIT PRICE
€ 489,00

CON STRIZZATRORE KINETIC
 CODE Assembled
CARR50567 - IP08949AST

PREZZO UNITARIO
 UNIT PRICE

CODE Disassembled
CARR50577 - IP08949SST

UNIT PRICE
€ 504,10



CODE	DIGIT	QUANTITY SUITE	QUANTITY PREMIUM
MPVR94816	0008	1	1
SECC00055	0609	1	1
SECC00055	0620	1	1
MPVR94820	0008	2	2
PRAL00081	0008	4	4
PMVR06751	0008	1	-
PMVR95672	0008	-	1
PMVR95671	0008	1	-
PMVR95682	0008	-	1
PMVR95681	0008	1	-
MPVR94839	0008	1	1
MPVR94847	0906	4	4
MPVR94858	0008	12	12
MPVR94851	0008	2	2
MPVR94838	0008	1	1
MPVR94821	0008	1	1
MPVR94822	0008	1	1
MPVR94843	0008	3	3
MPVR94842	0008	1	1
MPVR94837	0008	1	1
CHVR00056		1	1
PMLA96093	0008	1	1
MPVR94835	0008	1	1
STRI00030	IP09	1	1
PMVR06722	0013	1	1
PMVR06724	0013	1	1
MPVR94676	0006	1	-
MPVR94871	0008	2	2
MPVR94818	0006	1	1
MPVR94819	0008	1	1
MPVR94920	0008	1	1
MPVR10546		1	1
MPVR94850	0008	2	2
MPVR94860	0006	4	4
MPVR94841	0670	1	1

PT SYSTEM

PRE-TREAT MOPS CLEANING SYSTEM

The IPC's PT (pre-treat) System is a cleaning and sanitisation system which revolutionizes the manual floor cleaning concept by using pre-treat looped end yarn microfibre mops.

With this cleaning system the mops are prepared at least 4 hours beforehand, by impregnating them with a solution of water and detergent making them ready to be used.

MOP PREPARATION

PHASE 1

Place the 20 microfibre mops to treat in the blue 22 lt. bucket, being sure the bucket is perfectly clean and odourless.

PHASE 2

Pour the water and detergent solution. Over the mops in the correct quantity. For 20 mops, it is usually enough 1,5 lt. of solution.

PHASE 3

Close the 22 lt. bucket with the lid. Turn the 22 lt. bucket containing the clean mops and the detergent solution upside down and leave the mop in the bucket for at least 4 hours.

In this way all the mops WILL BE impregnated by osmosis.

BENEFITS

- **REDUCES WORKING TIMES**

as the mops are ready to be used and the operator does not have to fill buckets, wring mops or dilute products during cleaning.

- **SPEEDS UP**

any type of manual cleaning of floors etc.

- **EASY TO USE:**

the operator has mops ready to be used and once he arrives on site with the service trolley he can start cleaning straight away using a mop for each room.

- **MOPS CAN BE REUSED UNTIL WORN:**

the pre-treat mops can be used even 7-10 days after preparation, as long as the bucket is sealed at the end of work; this means that they can **BE EASILY TRANSPORTED IN THE BUCKET FROM ONE SITE TO ANOTHER FOR SEVERAL DAYS.**

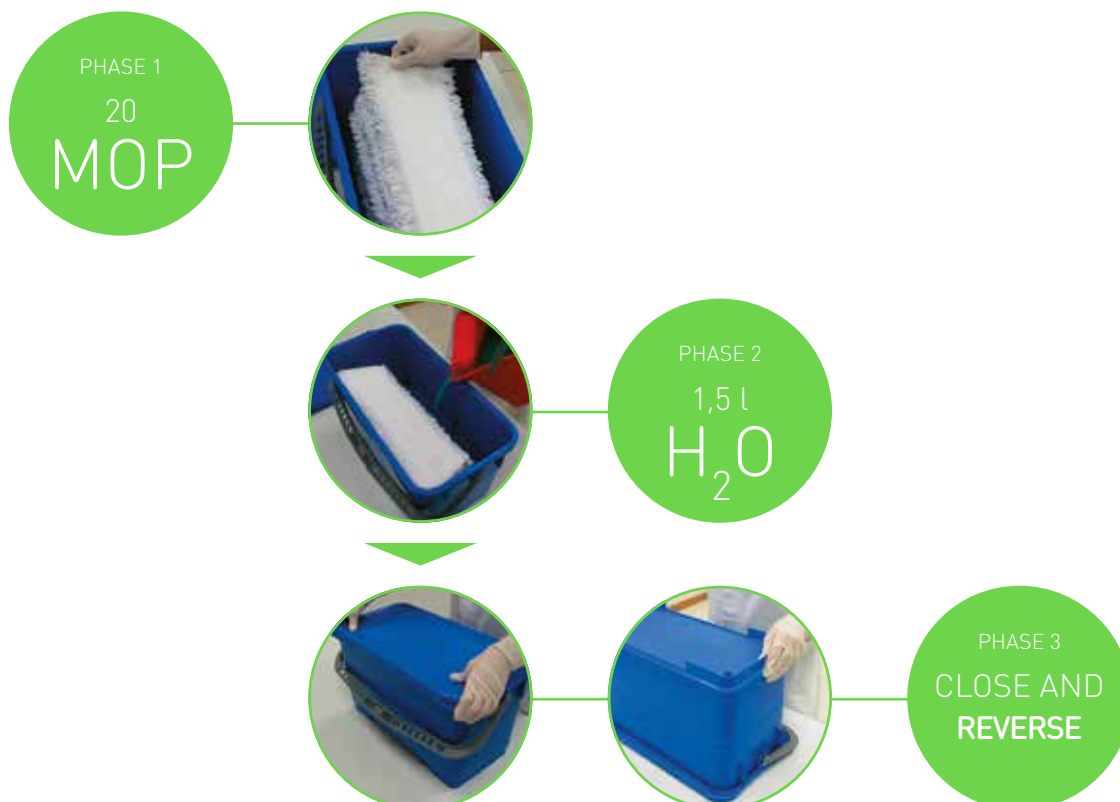

BRIX PT SUITE

CODE Assembled
CARR00571 - IP08038AST
 UNIT PRICE
€ 656,00

CODE Disassembled
CARR00571 - IP08038SST
 UNIT PRICE
€ 629,10

WITH FOLDING KIT
 CODE Assembled
CARR03094 - IP08

UNIT PRICE
€ 660,30



COMPOSITION

BRIX PT PREMIUM

CODE Assembled
CARR00571 - IP08039AST
 UNIT PRICE
€ 562,20

CODICE Disassemblato
 CODE Disassembled

UNIT PRICE
€ 535,20



	CODE	DIGIT	QUANTITY SUITE	QUANTITY PREMIUM
120 l Bag Support With Bumpers	MPVR94816	0008	1	1
22 l Polypropylene Bucket - Blue	SECC70027	NNB6	1	1
22 l Polypropylene Bucket - Red	SECC70027	NNR6	1	1
4 Covers For Lateral Panel	MPVR94820	0008	2	2
Aluminum Cylindrical Support 803 mm Type 1	PRAL00081	0008	4	4
Bar For Pedal	PMVR06751	0008	1	-
Base Complete With 4 Rubber Wheels (Metal Fork) Ø 100 mm	PMVR95672	0008	-	1
Base Complete With 4 Rubber Wheels (Nylon Fork) Ø 125 mm 2 With Brakes And 4 Bumpers	PMVR95671	0008	1	-
Base For Bag	PMVR95682	0008	-	1
Base For Bag With 2 Wheel Supports, 2 Wheels Ø 80 mm And Pedal Support	PMVR95681	0008	1	-
Bottom Insert For Countertop	MPVR94839	0008	1	1
Door Complete With Plastic Lock - Green Handle	MPVR94847	0906	4	4
Dovetail Insert	MPVR94858	0008	12	12
Flat Insert For Countertop	MPVR94851	0008	2	2
Grey Lid For Countertop Complete With Metal Key Lock Without Key	MPVR94838	0008	1	1
Hanging Hook For 22 l Bucket	PMLA96095	0008	1	1
Hinges (Double Version)	MPVR94821	0008	1	1
Lateral Neutral Panel	MPVR94843	0008	3	3
Lateral Panel With Brix Logo	MPVR94842	0008	1	1
Lid For 22 l Polypropylene Bucket - Blue	SECC70002		1	1
Lid For 22 l Polypropylene Bucket - Red	SECC70003		1	1
Lid For Bag Support	MPVR94837	0008	1	1
Metal Key Pair	CHVR00056		1	1
Mop Support	MPVR94835	0008	1	1
Pair of Bag Support Holders Fixed	PMVR06722	0013	1	1
Pair of Supports for Bag Support Holders	PMVR06724	0013	1	1
Pedal	MPVR94676	0006	1	-
Round Cover For Base Ø 25 mm	MPVR94871	0008	2	2
Round Cover For Base Ø 30 mm	MPVR94704	0006	2	2
Rubber Handle Holder Complete - For Brix PT Version	PMVR06633	0013	1	1
Set Of 6 Covers For Aluminum Support And Wrench	MPVR94818	0006	1	1
Set Of Handle, Tools And Safety Sign Holders	MPVR94819	0008	1	1
Set Of Upper Plate With Brix/IPC Logo, 1 Neutral Slot Covering Caps And 1 Slot Covering Cap "Made in Italy"	MPVR94920	0008	1	1
Shock Absorber for 120 l Lid	MPVR10546		1	1
Small Countertop	MPVR94850	0008	2	2
Soft Lateral Cover For Aluminum Cylindrical Support Light Grey	MPVR94860	0006	4	4
Transparent Lid For Countertop Complete With Plastic Lock	MPVR94841	0670	1	1
Upper Support For 22 l Bucket	COME00267	0008	1	1

ADVANTAGES

- **CHEMICAL PRODUCT REDUCTION OF 60%**
- **REAL EFFECTIVENESS**
Of the active ingredients
- **NO MOPS PREPARATION REQUIRED**
- **REMOVABLE SPARE PARTS**
and resistant to up to 500 washes in the washing machine
- **BATTERY AUTONOMY**
of 15/20 weeks with 5000 nebulizers

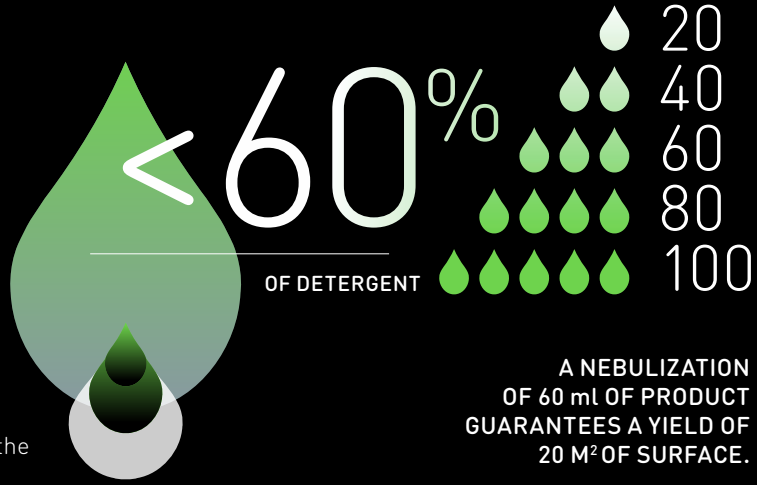

MORE HYGIENIC, MORE ECO-FRIENDLY



IMPREGNATION HEALTHINESS



AUTOMATIC DOSAGE SYSTEM



EQUIPPED with BATTERY and NEBULIZER



INNOVATIONS

#01



SMART DISINFECTION SYSTEM

DETAILS

#02

- With a simple push of button on the control panel, **THE MOP IS IMMEDIATELY IMPREGNATED AND READY TO USE.**
- Preparing the replacements the day before the cleaning operation, the risk of bacterial contamination is high.
- **WITH SDS, THE IMPREGNATION IS INSTANTANEOUS AT THE TIME OF USE** and the amount calibrated to the specific use situation or to the different requirements of the floor to be cleaned.

TROLLEYS

#03

**BRIX SDS SUITE
BRIX SDS PREMIUM**

BRIX COLLECTION SUITE

CODE Assembled
CARR00570 - IP08027AST

UNIT PRICE
€ 761,50

CODE Disassembled
CARR00570 - IP08027SST

UNIT PRICE
€ 734,60

**WITH
 FOLDING KIT**
 CODE Assembled
CARR03096 - IP08

UNIT PRICE
€ 770,00



DIMENSION
 mm 1660 x 610 x 1040 h



BRIX COLLECTION PREMIUM

CODE Assembled
CARR00570 - IP08015AST

UNIT PRICE
€ 631,20

CODE Disassembled
CARR00570 - IP08015SST

UNIT PRICE
€ 604,20



COMPOSITION	CODE	DIGIT	QUANTITY SUITE	QUANTITY PREMIUM	QUANTITY SMART
120 l Bag Support With Bumpers	MPVR94816	0008	2	2	1
4 Covers For Lateral Panel	MPVR94820	0008	2	2	2
Aluminum Cylindrical Support 803 mm Type 1	PRAL00081	0008	6	6	6
Bar For Pedal	PMVR06751	0008	2	-	1
Base Complete With 4 Rubber Wheels (Metal Fork) Ø 100 mm	PMVR95672	0008	-	1	-
Base Complete With 4 Rubber Wheels (Nylon Fork) Ø 125 mm 2 With Brakes And 4 Bumpers	PMVR95671	0008	1	-	1
Base For Bag	PMVR95682	0008	-	2	-
Base For Bag With 2 Wheel Supports, 2 Wheels Ø 80 mm And Pedal Support	PMVR95681	0008	2	-	1
Door Complete With Plastic Lock - Green Handle	MPVR94847	0906	8	8	-
Dovetail Insert	MPVR94858	0008	12	12	-
Flat Insert For Countertop	MPVR94851	0008	4	4	12
Grey Lid For Countertop Complete With Plastic Lock	MPVR94841	0608	4	4	4
Hinges (Double Version)	MPVR94821	0008	2	2	1
Large Countertop	MPVR94849	0008	2	2	-
Lateral Neutral Panel	MPVR94843	0008	3	3	2
Lateral Panel With Brix Logo	MPVR94842	0008	1	1	2
Lever Holding Bag	MPVR94633	0008	8	8	3
Lid For Bag Support	MPVR94837	0008	2	2	1
Middle Panel	MPVR94844	0008	2	2	8
Mop Support	MPVR94835	0008	1	1	-
Pair of Bag Support Holders Fixed	PMVR06722	0013	2	2	2
Pair of Supports for Bag Support Holders	PMVR06724	0013	2	2	1
Pedal	MPVR94676	0006	2	-	-
Round Cover For Base Ø 30 mm	MPVR94704	0006	2	2	2
Set Of 6 Covers For Aluminum Support And Wrench	MPVR94818	0006	1	1	1
Set Of Handle, Tools And Safety Sign Holders	MPVR94819	0008	1	1	1
Set Of Upper Plate With Brix/IPC Logo, 1 Neutral Slot Covering Caps And 1 Slot Covering Cap "Made in Italy"	MPVR94920	0008	1	1	1
Shock Absorber for 120 l Lid	MPVR10546		2	2	-
Soft Central Cover For Aluminum Cylindrical Support Light Grey	MPVR94859	0006	4	4	-

BRIX BAG COVER

- **EVEN MORE HYGIENIC & DISCREET**
- **ALL PANELS ARE FULLY CUSTOMIZABLE**
with specific advertisement banner
- **IDEAL FOR COMMUNITIES**
(stations, airports, shopping centers)
to promote products or services



CODE

MPVR10855

STD BLACK IS GREEN™

● 0208 ● 0213

● 0408 ● 0413

● 0508 ● 0513

● 0908 ● 0913

UNIT PRICE (1 KIT*)

€ 110,00

The kit includes cover bag without the customized panels

1 CHOOSE YOUR BRIX
TROLLEY



2 APPLY THE
BAG COVER



3 CUSTOMIZES
YOUR PANELS



BRIX COMPONENTS & ACCESSORIES

STRUCTURE

BASE COMPLETE WITH 4 RUBBER WHEELS Ø 100 MM (METAL FORK)

CODE
PMVR95672 - 0008

UNIT PRICE
€ 80,30



BASE COMPLETE WITH 4 RUBBER WHEELS Ø 100 MM (METAL FORK) 2 WITH BRAKES

CODE
PMVR95675 - 0008

UNIT PRICE
€ 86,90



BASE COMPLETE WITH 4 RUBBER WHEELS Ø 125 MM (NYLON FORK) WITH 1 BRAKE AND 4 BUMPERS

CODE
PMVR95678 - 0008

UNIT PRICE
€ 125,30



BASE COMPLETE WITH 4 RUBBER WHEELS Ø 125 MM (NYLON FORK) AND 4 BUMPERS

CODE
PMVR95674 - 0008

UNIT PRICE
€ 121,90



BASE COMPLETE WITH 4 RUBBER WHEELS Ø 125 MM (NYLON FORK) 2 WITH BRAKES AND 4 BUMPERS

CODE
PMVR95671 - 0008

UNIT PRICE
€ 128,50



BASE COMPLETE WITH 4 RUBBER WHEELS Ø 150 MM (NYLON FORK) AND 4 BUMPERS

CODE
PMVR95676 - 0008

UNIT PRICE
€ 240,80



RUBBER WHEEL Ø 100 MM (METAL FORK)

CODE
RTRT00557

UNIT PRICE
€ 9,85



RUBBER WHEEL Ø 100 MM WITH BRAKE (METAL FORK)

CODE
RTRT99629

UNIT PRICE
€ 13,10



DELUXE RUBBER WHEEL Ø 125 MM (METAL FORK)

CODE
RTRT00687

UNIT PRICE
€ 21,75



DELUXE RUBBER WHEEL Ø 125 MM WITH BRAKE (METAL FORK)

CODE
RTRT00688

UNIT PRICE
€ 26,20



RUBBER WHEEL Ø 125 MM (NYLON FORK)

CODE
RTRT00756

UNIT PRICE
€ 17,50



RUBBER WHEEL Ø 125 MM WITH BRAKE (NYLON FORK)

CODE
RTRT00757

UNIT PRICE
€ 20,90



RUBBER WHEEL Ø 150 MM (NYLON FORK)

CODE
RTRT00784

UNIT PRICE
€ 32,30



FIXING JUNCTION FOR WHEELS FOR COMPACT TROLLEYS

CODE
MPVR04773 - 0008

UNIT PRICE
€ 1,45



ADAPTATOR ANTIROTATION COMPACT

CODE
MPVR04775 - 0008

UNIT PRICE
€ 0,51



BUMPER FOR WHEEL

CODE
MPVR94855 - 0006

UNIT PRICE
€ 2,03



ROUND COVER FOR BASE Ø 25 MM

CODE
MPVR94871 - 0008

UNIT PRICE
€ 0,41



ROUND COVER FOR BASE Ø 30 MM

CODE
MPVR94704 - 0006

UNIT PRICE
€ 0,51



ALUMINUM CYLINDRICAL SUPPORT 803 MM

TYPE 1

CODE
PRAL00081 - 0008

UNIT PRICE
€ 9,20

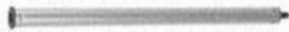

ALUMINUM CYLINDRICAL SUPPORT 1190 MM

TYPE 2

CODE
PRAL00082 - 0008

UNIT PRICE
€ 10,50

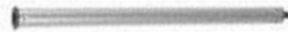

ALUMINUM CYLINDRICAL SUPPORT 400 MM

TYPE 3

CODE
PRAL00083 - 0008

UNIT PRICE
€ 7,60

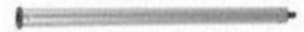

CENTRAL COVER

FOR ALUMINUM CYLINDRICAL SUPPORT LIGHT GREY

CODE SOFT VERSION
MPVR94859 - 0006

CODE HARD VERSION
MPVR04778 - 0006

UNIT PRICE
€ 3,90



CENTRAL COVER

FOR ALUMINUM CYLINDRICAL SUPPORT DARK GREY

CODE SOFT VERSION
MPVR94859 - 0008

CODE HARD VERSION
MPVR04778 - 0008

UNIT PRICE
€ 3,90



LATERAL COVER

FOR ALUMINUM CYLINDRICAL SUPPORT LIGHT GREY

CODE SOFT VERSION
MPVR94860 - 0006

CODE HARD VERSION
MPVR04769 - 0006

CODE SHORT HARD VERSION
MPVR11876 - 0006

UNIT PRICE
€ 3,90



LATERAL COVER

FOR ALUMINUM CYLINDRICAL SUPPORT DARK GREY

CODE SOFT VERSION
MPVR94860 - 0008

CODE VERSION HARD
MPVR04769 - 0008

UNIT PRICE
€ 3,90



LATERAL COVER

WITH HANDLE HOLDER FOR ALUMINUM CYLINDRICAL SUPPORT LIGHT GREY

CODE
PMVR01538 - 0006

UNIT PRICE
€ 8,75



LATERAL NEUTRAL PANEL

CODE
MPVR94843 - 0008

UNIT PRICE
€ 16,45



LATERAL PANEL

WITH BRIX LOGO

CODE
MPVR94842 - 0008

UNIT PRICE
€ 16,45



4 COVERS

FOR LATERAL PANEL

CODE
MPVR94820 - 0008

UNIT PRICE
€ 6,40



COVER

FOR LATERAL PANEL

CODE
MPVR94861 - 0008

UNIT PRICE
€ 1,43



MIDDLE PANEL

CODE
MPVR94844 - 0008

UNIT PRICE
€ 19,80



LARGE COUNTERTOP

CODE
MPVR94849 - 0008

UNIT PRICE
€ 33,40



SMALL COUNTERTOP

CODE
MPVR94850 - 0008

UNIT PRICE
€ 21,95



SMALL COUNTERTOP

WITH HOOKS FOR PUSHING HANDLE

CODE
MPVR10673 - 0008

UNIT PRICE
€ 46,00



DOVETAIL INSERT

CODE
MPVR94858 - 0008

UNIT PRICE
€ 0,61



DOVETAIL INSERT

WITH SLOT

CODE
MPVR04771 - 0008

UNIT PRICE
€ 0,61



DOVETAIL INSERT

WITH 4 HOLES

CODE
MPVR04772 - 0008
UNIT PRICE
€ 0,61



DOVETAIL HOOKING

CODE
MPVR94680 - 0006
UNIT PRICE
€ 1,32



SET OF 6 COVERS

FOR ALUMINUM SUPPORTS AND WRENCH

CODE
MPVR94818 - 0006
UNIT PRICE
€ 2,03



SET OF NEUTRAL UPPER PLATE WITH BRIX LOGO

3 NEUTRAL SLOT COVERING CAPS AND 1 SLOT COVERING CAP "MADE IN ITALY"

CODE
MPVR94828 - 0008
UNIT PRICE
€ 2,30



KIT COMPLETE

1 UPPER PLATE BRIX AND IPC LOGO, 4 SLOT COVERING CAP AND 1 SLOT COVERING CAP WITH "MADE IN ITALY"

CODE
MPVR11505 - 0008
UNIT PRICE
€ 2,30



SET OF NEUTRAL UPPER PLATE WITH BRIX LOGO

1 NEUTRAL SLOT COVERING CAP AND 1 SLOT COVERING CAP "MADE IN ITALY"

CODE
MPVR94823 - 0008
UNIT PRICE
€ 1,70



KIT COMPLETE

1 UPPER PLATE BRIX AND IPC LOGO, 1 SLOT COVERING CAP AND 1 SLOT COVERING CAP WITH "MADE IN ITALY"

CODE
MPVR94920 - 0008
UNIT PRICE
€ 1,70



UPPER PLATE

WITH BRIX LOGO

CODE
MPVR94873 - 0008
UNIT PRICE
€ 0,66



UPPER PLATE

WITH IPC LOGO AND BRIX LOGO

CODE
MPVR04776 - 0008
UNIT PRICE
€ 0,66



SLOT COVERING CAP

WITH "MADE IN ITALY"

CODE
MPVR94856 - 0008
UNIT PRICE
€ 0,61



SLOT COVERING CAP

CODE
MPVR94857 - 0008
UNIT PRICE
€ 0,61



BOTTOM INSERT

FOR COUNTERTOP

CODE
MPVR94839 - 0008
UNIT PRICE
€ 5,50



FLAT INSERT

FOR COUNTERTOP

CODE
MPVR94851 - 0008
UNIT PRICE
€ 6,30



GREY LID

FOR COUNTERTOP COMPLETE WITH METAL KEY LOCK

CODE with key
MPVR04794 - 0008
UNIT PRICE
€ 15,05



CODE without key
MPVR94838 - 0008
UNIT PRICE
€ 13,90

GREY LID

FOR COUNTERTOP COMPLETE WITH PLASTIC LOCK

CODE
MPVR94841 - 0608
UNIT PRICE
€ 7,45



TRANSPARENT LID

FOR COUNTERTOP COMPLETE WITH METAL KEY LOCK

CODE with key
MPVR04794 - 0070
UNIT PRICE
€ 15,95



CODE without key
MPVR94838 - 0070
UNIT PRICE
€ 14,85

TRANSPARENT LID

FOR COUNTERTOP COMPLETE WITH PLASTIC LOCK

CODE
MPVR94841 - 0670
UNIT PRICE
€ 8,55



LOCK COMPLETE

FOR LID

CODE
CHVR00057
UNIT PRICE
€ 8,25

3 HINGES

(DOUBLE VERSION)

CODE
MPVR94821 - 0008
UNIT PRICE
€ 1,02



3 HINGES
(SINGLE VERSION)

CODE
MPVR94822 - 0008

UNIT PRICE
€ 1,02



DOOR COMPLETE
WITH PLASTIC LOCK

CODE
MPVR94847

● 0506 ● 0206
● 0406 ● 0906

UNIT PRICE
€ 12,00



DOOR COMPLETE
WITH METAL KEY LOCK

CODE with key
MPVR04779

UNIT PRICE
€ 20,10

CODE without key
MPVR94848

UNIT PRICE
€ 19,00

● 0506 ● 0206
● 0406 ● 0906



COVER HANDLE
FOR DOORS

CODE
MPVR94891

● 0005 ● 0002 ● 0004 ● 0009

UNIT PRICE
€ 1,53



40 LT. BIG DRAWER

CODE
MPVR11495 - 0008

UNIT PRICE
€ 72,20



DIVIDER

FOR 40 LT. BRIX BIG DRAWER

CODE
MPVR11774 - 0013

UNIT PRICE
€ 31,70

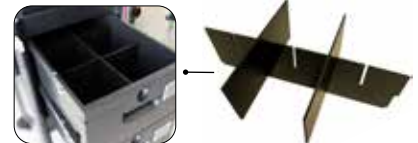

DRAWER COMPLETE
WITH FRONTAL COLORED PANEL

CODE with key
PMVR01547

UNIT PRICE
€ 44,70

CODE with plastic lock
PMVR06324

UNIT PRICE
€ 36,75

CODE without closure
PMVR95685

UNIT PRICE
€ 36,65

● 0508 ● 0208
● 0408 ● 0908
● 0608



LOCK COMPLETE
FOR DOORS & DRAWERS

CODE
CHVR00058

UNIT PRICE
€ 8,25

METAL KEY PAIR
FOR DOORS & DRAWERS

CODE
CHVR00056

UNIT PRICE
€ 1,12



PRE-IMPREGNATION GRID
FOR BRIX DRAWER

CODE
LAFN11599

UNIT PRICE
€ 30,00



WASTE COLLECTION

BASE FOR BAG

WITH 2 WHEEL SUPPORTS, 2 WHEELS Ø 80 MM AND PEDAL SUPPORT

CODE
PMVR95681 - 0008

UNIT PRICE
€ 44,70



BASE FOR BAG

WITH 2 WHEEL SUPPORTS AND 2 WHEELS Ø 80 MM

CODE
PMVR01539 - 0008

UNIT PRICE
€ 38,30



BASE FOR BAG

WITH 1 WHEEL SUPPORT AND 1 WHEEL Ø 80 MM

CODE
PMVR95680 - 0008

UNIT PRICE
€ 31,80



BASE FOR BAG

WITH PEDAL SUPPORT

CODE
PMVR95683 - 0008

UNIT PRICE
€ 31,60



BASE FOR BAG

CODE
PMVR95682 - 0008

UNIT PRICE
€ 25,30



WHEEL SUPPORT COMPLETE

WITH WHEEL Ø 80 MM

CODE
PMVR95687 - 0008

UNIT PRICE
€ 13,10



LOWER ROD

FOR MOP SUPPORT

CODE
PMVR06490 - 0008

UNIT PRICE
€ 14,35



MOP SUPPORT

CODE
MPVR94835 - 0008

UNIT PRICE
€ 4,30



ROUND COVER

(FOR BASE FOR BAG)

CODE
MPVR94870 - 0008

UNIT PRICE
€ 2,03



BAR FOR PEDAL

CODE
LAFN11599 - 0008

UNIT PRICE
€ 5,50



PEDAL SUPPORT

CODE
MPVR94879 - 0008

UNIT PRICE
€ 6,30



PEDAL

CODE
MPVR94676 - 0006

UNIT PRICE
€ 5,80



PAIR OF SUPPORTS FOR BAG SUPPORT HOLDER

CODE
PMVR06724 - 0013

UNIT PRICE
€ 7,00



PAIR OF BAG SUPPORT HOLDERS FIXED

CODE
PMVR06722 - 0013

UNIT PRICE
€ 13,30



120 LT. BAG SUPPORT WITH BUMPERS

CODE
MPVR94816 - 0008

UNIT PRICE
€ 27,40



2X70 LT. BAG SUPPORT WITH BUMPERS

CODE
PMVR95684 - 0008

UNIT PRICE
€ 31,80



3X40 LT. BAG SUPPORT WITH BUMPERS

CODE
PMVR06290 - 0008

UNIT PRICE
€ 35,20



SHOCK ABSORBER FOR BRIX LID

CODE
MPVR10546

UNIT PRICE
€ 2,95



DIVIDER FOR BAG SUPPORT (HOLDING 2X70 LT. BAGS)

CODE
MPVR94866 - 0008

UNIT PRICE
€ 2,03



LEVER HOLDING BAG

CODE
MPVR94633 - 0008

UNIT PRICE
€ 1,02



FOLDING KIT (BAG SUPPORT 120 LT)

CODE
KTRI06066 - 0008
UNIT PRICE
€ 112,00

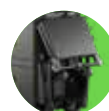

LEVER HOLDING BAG COUPLE
(FOR TRIPLE WASTE COLLECTION)

CODE
MPVR10649 - 0006
UNIT PRICE
€ 3,35



For a complete kit (triple waste collection),
3 couples are needed

UPPER ROD
FOR HOLDERS

CODE
PMVR06435 - 0008

UNIT PRICE
€ 14,60



HOLDER FOR TOOLS
COMPLETE

CODE
PMVR95638 - 0008

UNIT PRICE
€ 1,63



120 LT. GREY BAG
WITH FRONTAL ZIPPER

CODE
SACC00024 - 0006

UNIT PRICE
€ 43,05



35 LT. BAG
WITH STRING

CODE
SACC00038

● 0025 ● 0002

UNIT PRICE
€ 31,90



15 LT. BAG
WITH STRING FOR BRIX MICRO

CODE
SACC00059

● 0005 ● 0002

UNIT PRICE
€ 26,90



LID FOR BAG SUPPORT

CODE
MPVR94837 - 0008

UNIT PRICE
€ 9,95



SET OF HANDLE, TOOLS
AND SAFETY SIGN HOLDERS

CODE
MPVR94819 - 0008

UNIT PRICE
€ 4,40



SAFETY SIGN HOLDER
COMPLETE

CODE
PMVR95639 - 0008

UNIT PRICE
€ 1,63



DOCUMENT HOLDER

CODE
MPVR10647

UNIT PRICE
€ 14,25



HANDLE HOLDER
COMPLETE

CODE
PMVR95637 - 0008

UNIT PRICE
€ 1,10



RUBBER HANDLE HOLDER
COMPLETE

CODE standard
PMVR01545 - 0008

UNIT PRICE
€ 6,50



VERSION FOR BRIX PT

CODE
PMVR06633 - 0013

UNIT PRICE
€ 6,50

VERSION MAXI

CODE
PMVR06443 - 0008

UNIT PRICE
€ 7,75

70 LT. BAG
WITH STRING

CODE
SACC00036

● 0005 ● 0002

UNIT PRICE
€ 34,50



40 LT. BAG
WITH STRING

CODE
SACC00061

● 0005 ● 0002
● 0003 ● 0004

UNIT PRICE
€ 32,00



EXTRACTIBLE SUPPORT
FOR 2x15 LT.BAGS

CODE
COME00314 - 0008

UNIT PRICE
€ 59,20



90 LT. NET
FOR MOP WASHING

CODE
SACC00002

● 0501 ● 0201

UNIT PRICE
€ 11,80



70 LT. NET
FOR MOP WASHING

CODE SACC00001 CODE SACC00009

○ 0001 ● 1501 ● 0201
● 0301 ● 0401

UNIT PRICE
€ 8,35

UNIT PRICE
€ 8,35



35 LT. NET
FOR MOP WASHING

CODE
SACC00017 - 0201



UNIT PRICE
€ 9,75

SET OF 4 HOOKS FOR NET
FOR MOP WASHING SUITABLE FOR 120 LT. OR 2X70 LT. BAG SUPPORT

CODE
KTRI05213
UNIT PRICE
€ 6,00



SUITABLE FOR 3X40 LT.
BAG SUPPORT

CODE
KTRI05214
UNIT PRICE
€ 6,00

PUSHING SYSTEMS

SHORT VERSION KIT
WITH 2 CILINDRICAL SUPPORT

CODE
PMVR06377

UNIT PRICE
€ 96,90



LONG VERSION KIT
WITH 2 CILINDRICAL SUPPORT

CODE
PMVR06378

UNIT PRICE
€ 102,30



CYLINDRICAL SUPPORT
FOR ADJUSTABLE HANDLE

CODE
PRAL00119 - 0008

UNIT PRICE
€ 9,10



PUSHING HANDLE
COMPLETE WITH HOOKS FOR SMALL COUNTERTOP

CODE
KTRI04784 - 0006

UNIT PRICE
€ 13,50



PUSHING HANDLE

CODE
MPVR94594 - 0006

UNIT PRICE
€ 7,45



PUSHING HANDLE COMPLETE
WITH BUMPERS

CODE
MPVR94854 - 0008

UNIT PRICE
€ 15,50



9 LT. TRAY FOR MOPS/TOOLS
(FITS THE PUSHING HANDLE)

CODE
MPVR94836 - 0008

UNIT PRICE
€ 12,00



LID FOR 9 LT. TRAY
WITH HINGES

CODE
MPVR94840 - 0008

UNIT PRICE
€ 7,65



METAL SUPPORTS
FOR 9 L TRAY

CODE
COME00329

UNIT PRICE
€ 30,25



PRE-IMPREGRATION GRID
FOR 9 LT. TRAY

CODE
LAFN11596

UNIT PRICE
€ 22,50



KIT 6 LT. TRAY
WITH SUPPORTS

CODE
KTRI05036
UNIT PRICE
€ 17,70

6 LT. TRAY

CODE
MPVR10852 - 0008
UNIT PRICE
€ 10,30



SUPPORT FOR 6 LT. TRAY
(SINGLE)

CODE
MPVR10679 - 0008
UNIT PRICE
€ 3,90

WASHING & DUSTING SYSTEMS

KINETIC PLUS WRINGER

CODE
STRI00072

● IP09

UNIT PRICE
€ 70,00



NEW LINE / STRONG WRINGER

CODE
STRI00030

● IP15 ● IP02
● IP09 ● IP04

UNIT PRICE
€ 54,90



SPEED / BOOK WRINGER

CODE
STRI00003

● 0015 ● 0002
● 0009 ● 0004

UNIT PRICE
€ 49,50



SPEED / BOOK WRINGER

CODE
STRI00007

● 0015 ● 0002
● 0009 ● 0004

UNIT PRICE
€ 98,90



METAL WRINGER SUPPORT COMPLETE WITH PLASTIC INSERTS FOR BASE

CODE standard
PMLA96093 - 0008

UNIT PRICE
€ 15,45

CODE for base for bag
COME00310 - 0008

UNIT PRICE
€ 37,70



15 LT. BUCKET

CODE
SECC00055

● 0605 ● 0602
● 0609 ● 0620

UNIT PRICE
€ 13,90



6 LT. BUCKET GREY WITH COLORED HANDLE

CODE
SECC00056

● 0508 ● 0208
● 0908 ● 0408

UNIT PRICE
€ 6,60



LID FOR 6 LT. BUCKET GREY

CODE
MPVR10854 - 0008

UNIT PRICE
€ 5,90



RUBBER INSERT FOR 6 LT. BUCKET

CODE
LAMU00021

UNIT PRICE
€ 8,95



RUBBER INSERT FOR 6 LT. BUCKETS WITH TWO 6 LT. BUCKETS INCLUDED

CODE KIT:
KTRI01548

UNIT PRICE
€ 21,95

6 LT. BUCKET SWIVEL SUPPORTS FOR BRIX LIGHT

CODE KIT (DX + SX)
PMVR06420 - 0008

UNIT PRICE
€ 31,70

CODE KIT DX
COME00332 - 0008

UNIT PRICE
€ 15,85

CODE KIT SX
COME00333 - 0008

UNIT PRICE
€ 15,85



6 LT. BUCKET SWIVEL SUPPORTS FOR BRIX

CODE KIT (DX + SX)
PMVR06423 - 0008

UNIT PRICE
€ 29,65

CODE KIT DX
COME00334 - 0008

UNIT PRICE
€ 14,85

CODE KIT SX
COME00335 - 0008

UNIT PRICE
€ 14,85



HOLDER FOR 6 LT. BUCKET FOR 35 LT. BAG

CODE
PMVR95688 - 0008

UNIT PRICE
€ 7,45



PRE-TREAT SYSTEMS

22 LT. POLYPROPYLENE BUCKET

CODE SECC70027

- NNR6
- NNB6

UNIT PRICE € 13,00



LID FOR 22 LT. BUCKET

CODE SECC70003

CODE SECC70002

UNIT PRICE € 6,70



MOP DIVIDER FOR 22 LT. BUCKET

CODE MPVR11725

UNIT PRICE € 38,80

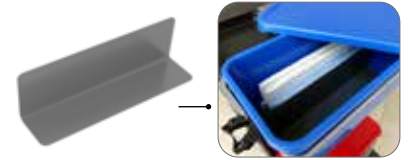

PRE-IMPREGRATION GRID FOR 22 LT. TRAY

CODE LAFN11597

UNIT PRICE € 45,80



UPPER SUPPORT FOR 22 LT. BUCKET

CODE COME00267 - 0008

UNIT PRICE € 53,00



LOWER SUPPORT FOR 22 LT. BUCKET

CODE COME00268 - 0008

UNIT PRICE € 55,20



HANGING HOOK FOR 22 LT. BUCKET

CODE PMLA96095 - 0081

UNIT PRICE € 23,30



GLOVES BOX HOLDER



CODE COME00385

UNIT PRICE € 15,00



SUPPORT FOR 9 LT. TRAY



CODE PMVR06812 - 0081

UNIT PRICE € 27,00



GEL BOTTLE HOLDER



CODE KTRI06260 - 0081

UNIT PRICE € 27,50



CLEANING TROLLEYS RANGE /

STARACE

&

ANTARES

COMPLETE

RANGE

STARACE 100

CODE
CARR00396 - 0006

UNIT PRICE
€ 182,40



TECHNICAL DATA

Support
VARNISHED

Trolley dimensions
L x L x h
cm 66 x 85 x 112 h

Volume
0,207 m³

Base dimensions
L x l
cm 85 X 51,5

Weight
13 kg

Bucket capacity
2 x 6 l

Bag capacity
120 l

COMPOSITION	CODE	DIGIT	UNIT PRICE
BASE PPL WITH 4 RUBBER WHEELS Ø 100 MM (METAL FORK)	PMVR95743	●0006	€ 80,60
VARNISHEDSUPPORT WITH FRONTAL HOLES	PMLA96096	●0006	€ 18,70
CLIP PPL FOR RILSAN SUPPORT	MPVR94752	●0006	€ 0,82
FIBREGLASS SUPPORT FOR ACCESSORIES WITH DOVETAIL JOINT	MPVR94773	●0006	€ 7,45
FIBREGLASS SUPPORT FOR ACCESSORIES WITH DOUBLE DOVETAIL JOINT	MPVR94774	●0006	€ 9,25
SUPPORT FOR 120 LT. BAG (COMPLETE WITH CLIP FIXING BAG AND LATERAL REINFORCING SUPPORTS)	PMVR95752	●0006	€ 21,20
POLYPROPYLENE TRAY TYPE 3	MPVR94602	●0006	€ 10,30
6 LT. BUCKET	SECC00056	●0615 ●0618	€ 6,60
HANDLE HOLDER	PMVR95640	●0006	€ 3,70
MOP SUPPORT	MPVR94615	●0006	€ 5,90
NYLON COVER	MPVR94584	●0009	€ 1,02
COVER FOR BASE	MPVR94704	●0006	€ 0,51

BAG 120 LT. Optional

MAIN ACCESSORIES / OPTIONALS

SAFETY SIGN HOLDER

CODE
PMVR95642 - 0006



CLIP FIXING BAG

CODE
MPVR94633 - 0006



LID FOR 120 LT. BAG SUPPORT

CODE
MPVR94593 - 0006



SECURITY KIT

CODE
PMVR95754 - 0006



BAG SUPPORT 2 X 70 LT.

CODE
PMVR95753 - 0006



120 LT. BAG

CODE
SACC00008

● 0005
● 0002



6 LT. BUCKETS

CODE
SECC00056

● 0615
● 0618
● 0617
● 0604



MULTILINGUAL SAFETY SIGN

CODE
CART00026



STARACE 102

WITH NEW LINE WINGER
CODE
CARR00390 - IP06

WITH KINETIC WRINGER
CODE
CARR50390 - IP06

UNIT PRICE
€ 336,10

UNIT PRICE
€ 351,20



TECHNICAL DATA

Support
VARNISHED

Trolley dimensions
L x L x h
cm 76 x 128 x 104 h

Volume
0,325 m³

Base dimensions
L x l
cm 85 X 51,5

Weight
21 kg

Bucket capacity
2 x 15 l

Bag capacity
120 l

**DISPONIBILE ANCHE
NELLA VERSIONE
BLACK IS GREEN™**

WITH NEW LINE
CODE
CARR02574 - 0099
UNIT PRICE €
316,80

WITH KINETIC
CODE
CARR52574 - 0099
UNIT PRICE
€ **331,90**

COMPOSITION	CODE	DIGIT	UNIT PRICE
BASE WITH 4 RUBBER WHEELS Ø 100 MM (METAL FORK)	PMVR95743	● 0006	€ 80,60
VARNISHED SUPPORT WITH LATERAL HOLES	PMLA96081	● 0006	€ 18,70
FIBREGLOSS SUPPORT FOR ACCESSORIES WITH DOVETAIL JOINT	MPVR94773	● 0006	€ 7,45
SUPPORT FOR 120 LT. BAG (COMPLETE WITH CLIP FIXING BAG AND LATERAL REINFORCING SUPPORTS)	PMVR95752	● 0006	€ 21,20
POLYPROPYLENE SUPPORT FOR TRAY	MPVR94617	● 0006	€ 7,15
FIBREGLOSS SUPPORT FOR TRAY (CODE MPVR94560 - 0006)	MPVR94616	● 0006	€ 7,35
POLYPROPYLENE TRAY	MPVR94560	● 0006	€ 9,45
SUPPORT FOR WRINGER	PMLA96082	● 0006	€ 16,45
15 LT. BUCKET	SECC00055	● 0615 ● 0618	€ 13,90
NEW LINE/STRONG WRINGER	STRI00030	● IP15	€ 54,90
HANDLE HOLDER	PMVR95640	● 0006	€ 3,70
MOP SUPPORT	MPVR94615	● 0006	€ 5,90
NYLON COVER	MPVR94584	● 0009	€ 1,02
COVER FOR BASE	MPVR94704	● 0006	€ 0,51
KINETIC WRINGER	STRI00072	● IP09	€ 70,00

BAG 120 LT. Optional

MAIN ACCESSORIES / OPTIONALS

**NEW LINE/STRONG
WRINGER**

CODE
STRI00030

● IP15



**SPEED / BOOK
WRINGER**

CODE
STRI00003

● 0015



**ROLLER / RULLY
WRINGER**

CODE
STRI00007

● IP15



**FLEXIBLE
WATER PIPE**
FOR FILLING BUCKETS

CODE
TBBP00516



**SAFETY SIGN
HOLDER**

CODE
PMVR95642 - 0006



**CLIP FIXING
BAG**

CODE
MPVR94633 - 0006



**CLIP FIXING
BAG**

CODE
MPVR94593 - 0006



SECURITY KIT

CODE
PMVR95754 - 0006



**BAG SUPPORT
2 X 70 LT.**

CODE
PMVR95753 - 0006



120 LT. BAG

CODE
SACC00008

● 0005
● 0002



6 LT. BUCKETS

CODE
SECC00056

● 0615
● 0618
● 0617
● 0604



**MULTILINGUAL
SAFETY SIGN**

CODE
CART00026



For trolleys without wringers subtract € 25,00 from the list price

STARACE 103

WITH NEW LINE WRINGER
CODE
CARR00637 - IP06

UNIT PRICE
€ 317,70

WITH KINETIC WRINGER
DOCE
CARR50637 - IP06

UNIT PRICE
€ 332,80



TECHNICAL DATA

Support
VARNISHED

Trolley dimensions
L x L x h
cm 66 x 85 x 112 h

Volume
0,325 m³

Base dimensions
L x l
cm 85 X 51,5

Weight
13 kg

Bucket capacity 2 x 6 l

Bag capacity
120 l

COMPOSITION	CODE	DIGIT	UNIT PRICE
BASE WITH 4 RUBBER WHEELS Ø 100 MM (METAL FORK)	PMVR95743	● 0006	€ 80,60
VARNISHED SUPPORT WITH LATERAL HOLES	PMLA96096	● 0006	€ 18,70
POLYPROPYLENE CLIP FOR RILSAN SUPPORT	MPVR94752	● 0006	€ 0,82
FIBREGLASS SUPPORT FOR ACCESSORIES WITH DOVETAIL JOINT	MPVR94773	● 0006	€ 7,45
FIBREGLASS SUPPORT FOR ACCESSORIES WITH DOUBLE DOVETAIL JOINT	MPVR94774	● 0006	€ 9,25
SUPPORT FOR 120 LT. BAG (COMPLETE WITH CLIP FIXING BAG AND LATERAL REINFORCING SUPPORTS)	PMVR95752	● 0006	€ 21,20
POLYPROPYLENE TRAY TYPE 3	MPVR94602	● 0006	€ 10,30
SUPPORT FOR WRINGER	PMLA96082	● 0006	€ 16,45
15 LT. BUCKET	SECC00055	● 0615 ● 0618	€ 13,90
6 LT. BUCKET	SECC00056	● 0615 ● 0618	€ 6,60
NEW LINE/STRONG WRINGER	STRI00030	● IP15	€ 54,90
HANDLE HOLDER	PMVR95640	● 0006	€ 3,70
MOP SUPPORT	MPVR94615	● 0006	€ 5,90
NYLON COVER	MPVR94584	● 0009	€ 1,02
COVER FOR BASE	MPVR94704	● 0006	€ 0,51
KINETIC WRINGER	STRI00072	● IP09	€ 70,00

BAG 120 LT. Optional

MAIN ACCESSORIES / OPTIONALS

NEW LINE/STRONG WRINGER

CODE
STRI00030

● IP15



SPEED / BOOK WRINGER

CODE
STRI00003

● 0015



ROLLER / RULLY WRINGER

CODE
STRI00007

● IP15



FLEXIBLE WATER PIPE FOR FILLING BUCKETS

CODE
TBBP00516



6 LT. BUCKETS

CODE
SECC00056

● 0615
● 0618
● 0617
● 0604



For trolleys without wringers subtract € 25.00 from the list price

STARACE 104

CODE
CARR00657 - IP06

UNIT PRICE
€ 222,90



TECHNICAL DATA

Support
VARNISHED

Trolley dimensions
L x L x h
cm 66 x 85 x 104 h

Volume
0,207 m³

Base dimensions
L x l
cm 85 X 51,5

Weight
14 kg

Bag capacity
120 l

COMPOSITION	CODE	DIGIT	UNIT PRICE
BASE WITH 4 RUBBER WHEELS Ø 100 MM (METAL FORK)	PMVR95743	●0006	€ 80,60
VARNISHED SUPPORT WITH LATERAL HOLES	PMLA96081	●0006	€ 18,70
FIBREGLASS SUPPORT FOR ACCESSORIES WITH DOVETAIL JOINT	MPVR94773	●0006	€ 7,45
SUPPORT FOR 120 LT. BAG (COMPLETE WITH CLIP FIXING BAG AND LATERAL REINFORCING SUPPORTS)	PMVR95752	●0006	€ 21,20
POLYPROPYLENE SUPPORT FOR TRY	MPVR94617	●0006	€ 7,15
POLYPROPYLENE TRAY	MPVR94560	●0006	€ 9,45
HANDLE HOLDER	PMVR95640	●0006	€ 3,70
MOP SUPPORT	MPVR94615	●0006	€ 5,90
NYLON COVER	MPVR94584	●0009	€ 1,02
COVER FOR BASE	MPVR94704	●0006	€ 0,51

BAG 120 LT. Optional

MAIN ACCESSORIES / OPTIONALS

FLEXIBLE WATER PIPE FOR FILLING BUCKETS

CODE
TBBP00516



SAFETY SIGN HOLDER

CODE
PMVR95642 - 0006



CLIP FIXING BAG

CODE
MPVR94633 - 0006



LID FOR 120 LT. BAG SUPPORT

CODE
MPVR94593 - 0006



SECURITY KIT

CODE
PMVR95754 - 0006



BAG SUPPORT 2 X 70 LT.

CODE
PMVR95753 - 0006



120 LT. BAG

CODE
SACC00008

● 0005
● 0002



6 LT. BUCKETS

CODE
SECC00056

● 0615
● 0618
● 0617
● 0604



MULTILINGUAL SAFETY SIGN

CODE
CART00026



STARACE 105

WITH NEW LINE WRINGER
CODE
CARR00666 - IP06

UNIT PRICE
€ 281,10

WITH KINETIC WRINGER
CODE
CARR50666 - IP06

UNIT PRICE
€ 296,20



TECHNICAL DATA

Support
RILSAN

Trolley dimensions
L x L x h
cm 66 x 135 x 104 h

Volume
0,217 m³

Base dimensions
L x l
cm 85 X 51,5

Weight
17 kg

Bag capacity
120 l

COMPOSITION	CODE	DIGIT	UNIT PRICE
BASE WITH 4 RUBBER WHEELS Ø 100 MM (METAL FORK)	PMVR95743	● 0006	€ 80,60
RILSAN SUPPORT WITH LATERAL HOLES	LAFN99624	-	€ 12,05
RILSAN BAR FOR SUPPORT	LAFN99614	-	€ 9,75
POLYPROPYLENE CLIP FOR RILSAN SUPPORT	MPVR94752	● 0006	€ 0,82
FIBREGLASS SUPPORT FOR ACCESSORIES WITH DOVETAIL JOINT	MPVR94773	● 0006	€ 7,45
FIBREGLASS SUPPORT FOR ACCESSORIES WITH DOUBLE DOVETAIL JOINT	MPVR94774	● 0006	€ 9,25
SUPPORT FOR 120 LT. BAG (COMPLETE WITH CLIP FIXING BAG AND LATERAL REINFORCING SUPPORTS)	PMVR95752	● 0006	€ 21,20
POLYPROPYLENE TRAY TYPE 3	MPVR94602	● 0006	€ 10,30
15 LT. BUCKET	SECC00055	● 0615 ● 0618	€ 13,90
6 LT. BUCKET	SECC00056	● 0615 ● 0618	€ 6,60
NEW LINE/STRONG WRINGER	STRI00030	● IP15	€ 54,90
RILSAN SUPPORT FOR TRAY	LAFN99613	-	€ 11,00
SUPPORT FOR WRINGER	PMLA96082	● 0006	€ 16,45
HANDLE HOLDER	PMVR95640	● 0006	€ 3,70
MOP SUPPORT	MPVR94615	● 0006	€ 5,90
NYLON COVER	MPVR94584	● 0009	€ 1,02
COVER FOR BASE	MPVR94704	● 0006	€ 0,51
KINETIC WRINGER	STRI00072	● IP09	€ 70,00

BAG 120 LT. Optional

MAIN ACCESSORIES / OPTIONALS

NEW LINE/STRONG WRINGER

CODE
STRI00030

● IP15



SPEED / BOOK WRINGER

CODE
STRI00003

● 0015



ROLLER / RULLY WRINGER

CODE
STRI00007

● IP15



FLEXIBLE WATER PIPE FOR FILLING BUCKETS

CODE
TBBP00516



6 LT. BUCKETS

CODE
SECC00056

● 0615
● 0618
● 0617
● 0604



For trolleys without wringers subtract € 25.00 from the list price

STARACE 107

WITH NEW LINE WRINGER
 CODE
 CARR00392 - IP06

UNIT PRICE
 € 271,30

WITH KINETIC WRINGER
 CODE
 CARR50392 - IP06

UNIT PRICE
 € 286,40



TECHNICAL DATA

Support
 VARNISHED

Trolley dimensions
 L x L x h
 cm 76 x 85 x 112 h

Volume
 0,217 m³

Base dimensions
 L x l
 cm 85 X 51,5

Weight
 17 kg

Bag capacity
 120 l

COMPOSITION	CODE	DIGIT	UNIT PRICE
BASE WITH 4 RUBBER WHEELS Ø 100 MM (METAL FORK)	PMVR95743	● 0006	€ 80,60
VARNISHED SUPPORT WITH LATERAL HOLES	PMLA96096	● 0006	€ 18,70
POLYPROPYLENE CLIP FOR RILSAN SUPPORT	MPVR94752	● 0006	€ 0,82
FIBREGLASS SUPPORT FOR ACCESSORIES WITH DOUBLE DOVETAIL JOINT	MPVR94774	● 0006	€ 9,25
SUPPORT FOR 120 LT. BAG (COMPLETE WITH CLIP FIXING BAG AND LATERAL REINFORCING SUPPORTS)	PMVR95752	● 0006	€ 21,20
POLYPROPYLENE TRAY TYPE 3	MPVR94602	● 0006	€ 10,30
15 LT. BUCKET	SECC00055	● 0615 ● 0618	€ 13,90
6 LT. BUCKET	SECC00056	● 0615 ● 0618	€ 6,60
NEW LINE/STRONG WRINGER	STRI00030	● IP15	€ 54,90
SUPPORT FOR WRINGER	PMLA96082	● 0006	€ 16,45
HANDLE HOLDER	PMVR95640	● 0006	€ 3,70
MOP SUPPORT	MPVR94615	● 0006	€ 5,90
NYLON COVER	MPVR94584	● 0009	€ 1,02
COVER FOR BASE	MPVR94704	● 0006	€ 0,51
KINETIC WRINGER	STRI00072	● IP09	€ 70,00

SACCO 120 LT. Optional

MAIN ACCESSORIES / OPTIONALS

SECURITY KIT

CODE
 PMVR95754 - 0006



BAG SUPPORT 2 X 70 LT.

CODE
 PMVR95753 - 0006



LID FOR 120 LT. BAG SUPPORT

CODE
 MPVR94593 - 0006



120 LT. BAG

CODE
 SACC00008



For trolleys without wringers subtract € 25.00 from the list price

STARACE 108

WITH NEW LINE WRINGER
CODE
CARR00400

UNIT PRICE
€ 247,80

WITH KINETIC WRINGER
CODE
CARR50400

UNIT PRICE
€ 262,90

● IP06 ● IP23



TECHNICAL DATA

Support
VARNISHED

Trolley dimensions
l x L x h (cm)
76 x 89 x 111 h

Volume
0,217 m³

Weight
15 kg

Bucket capacity
2 x 6 l + 2 x 15 l

Bag capacity
120 l

COMPOSITION	CODE	DIGIT	UNIT PRICE
BASE WITH 4 RUBBER WHEELS Ø 100 MM (METAL FORK)	PMVR95750	● 0006	€ 68,10
VARNISHED SUPPORT	PMLA96086	● 0006	€ 19,90
POLYPROPYLENE CLIP FOR RILSAN SUPPORT	MPVR94752	● 0006	€ 0,82
FIBREGLASS SUPPORT FOR ACCESSORIES WITH DOUBLE DOVETAIL JOINT	MPVR94774	● 0006	€ 9,25
SUPPORT FOR 120 LT. BAG (COMPLETE WITH CLIP FIXING BAG AND LATERAL REINFORCING SUPPORTS)	PMVR95752	● 0006	€ 21,20
POLYPROPYLENE TRAY TYPE 3	MPVR94602	● 0006	€ 10,30
15 LT. BUCKET	SECC00055	● 0615 ● 0618	€ 13,90
6 LT. BUCKET	SECC00056	● 0615 ● 0618	€ 6,60
NEW LINE/STRONG WRINGER	STRI00030	● IP15	€ 54,90
SUPPORT FOR WRINGER	PMLA96082	● 0006	€ 16,45
HANDLE HOLDER	PMVR95640	● 0006	€ 3,70
MOP SUPPORT	MPVR94599	● 0006	€ 5,30
NYLON COVER	MPVR94584	● 0009	€ 1,02
COVER FOR BASE	MPVR94704	● 0006	€ 0,51
KINETIC WRINGER	STRI00072	● IP09	€ 70,00

BAG 120 LT. Optional

MAIN ACCESSORIES / OPTIONALS

FLEXIBLE WATER PIPE FOR FILLING BUCKETS

CODE
TBBP00516



SAFETY SIGN HOLDER

CODE
PMVR95642 - 0006



120 LT. BAG

CODE
SACC00008

● 0005
● 0002



MULTILINGUAL SAFETY SIGN

CODE
CART00026



For trolleys without wringers subtract € 25.00 from the list price

STARACE 109

CODE
CARR00405

● IP06 ● IP23

UNIT PRICE
€ 173,20



TECHNICAL DATA

Support
VARNISHED

Trolley dimensions
L x L x h
cm 67 x 85 x 111 h

Volume
0,217 m³

Weight
11 kg

Bag capacity
120 l

COMPOSITION	CODE	DIGIT	UNIT PRICE
BASE WITH 4 RUBBER WHEELS Ø 100 MM (METAL FORK)	PMVR95750	● 0006	€ 68,10
VARNISHED SUPPORT	PMLA96086	● 0006	€ 19,90
POLYPROPYLENE CLIP FOR RILSAN SUPPORT	MPVR94752	● 0006	€ 0,82
FIBREGLASS SUPPORT FOR ACCESSORIES WITH DOVETAIL JOINT	MPVR94773	● 0006	€ 7,45
FIBREGLASS SUPPORT FOR ACCESSORIES WITH DOUBLE DOVETAIL JOINT	MPVR94774	● 0006	€ 9,25
SUPPORT FOR 120 LT. BAG (COMPLETE WITH CLIP FIXING BAG AND LATERAL REINFORCING SUPPORTS)	PMVR95589	● 0006	€ 37,40
POLYPROPYLENE TRAY TYPE 3	MPVR94602	● 0006	€ 10,30
6 LT. BUCKET	SECC00056	● 0615 ● 0618	€ 6,60
HANDLE HOLDER	PMVR95640	● 0006	€ 3,70
MOP SUPPORT	MPVR94599	● 0006	€ 5,30
NYLON COVER	MPVR94584	● 0009	€ 1,02
COVER FOR BASE	MPVR94704	● 0006	€ 0,51

BAG 120 LT. Optional

MAIN ACCESSORIES / OPTIONALS

FLEXIBLE WATER PIPE FOR FILLING BUCKETS

CODE
TBBP00516



SAFETY SIGN HOLDER

CODE
PMVR95642 - 0006



CLIP FIXING BAG

CODE
MPVR94633 - 0006



LID FOR 120 LT. BAG SUPPORT

CODE
MPVR94593 - 0006



SECURITY KIT

CODE
PMVR95754 - 0006



BAG SUPPORT 2 X 70 LT.

CODE
PMVR95753 - 0006



120 LT. BAG

CODE
SACC00008

● 0005
● 0002



6 LT. BUCKETS

CODE
SECC00056

● 0615
● 0618
● 0617
● 0604



MULTILINGUAL SAFETY SIGN

CODE
CART00026



STARACE 111

WITH NEW LINE WRINGER
CODE
CARR00408

UNIT PRICE
€ 297,70

WITH KINETIC WRINGER
CODE
CARR50408

UNIT PRICE
€ 312,80

● IP06 ● IP23



TECHNICAL DATA

Support
VARNISHED

Trolley dimensions
l x L x h
cm 76x118x115 h

Volume
0,325 m³

Weight
20 kg

Bag capacity
120 l

COMPOSITION	CODE	DIGIT	UNIT PRICE
BASE WITH 4 RUBBER WHEELS Ø 100 MM (METAL FORK)	PMVR95750	● 0006	€ 68,10
VARNISHED SUPPOR TYPE 3	PMLA96078	● 0006	€ 25,40
VARNISHED SUPPOR TYPE 4	PMLA96079	● 0006	€ 21,95
VARNISHED SUPPORT FOR WRINGER	PMLA96082	● 0006	€ 16,45
SUPPORT FOR 120 LT. BAG (COMPLETE WITH CLIP FIXING BAG AND LATERAL REINFORCING SUPPORTS)	PMVR95752	● 0006	€ 21,20
POLYPROPYLENE BASE FOR BAG (COMPLETE WITH Ø 50 MM WHEEL)	PMVR95776	● 0006	€ 17,50
POLYPROPYLENE TRAY	MPVR94559	● 0006	€ 5,50
15 LT. BUCKET	SECC00055	● 0615 ● 0618	€ 13,90
9 LT. BUCKET	SECC00054	● 0615 ● 0618	€ 7,25
NEW LINE/STRONG WRINGER	STRI00030	● IP15	€ 54,90
HANDLE HOLDER	PMVR95640	● 0006	€ 3,70
MOP SUPPORT	MPVR94599	● 0006	€ 5,30
NYLON COVER	MPVR94584	● 0009	€ 1,02
COVER FOR BASE	MPVR94704	● 0006	€ 0,51
LOCKING LEVER FOR BASE	MPVR94604	● 0006	€ 0,82
KINETIC WRINGER	STRI00072	● IP09	€ 70,00

BAG 120 LT. Optional

MAIN ACCESSORIES / OPTIONALS

FLEXIBLE WATER PIPE FOR FILLING BUCKETS

CODE
TBBP00516



SAFETY SIGN HOLDER

CODE
PMVR95642 - 0006



120 LT. BAG

CODE
SACC00008

● 0005
● 0002



6 LT. BUCKETS

CODE
SECC00056

● 0615
● 0618
● 0617
● 0604



MULTILINGUAL SAFETY SIGN

CODE
CART00026



For trolleys without wringers subtract € 25.00 from the list price

STARACE 112

CODE
CARR00685 - IP06

UNIT PRICE
€ 444,90



TECHNICAL DATA

Support
VARNISHED

Trolley dimensions
L x L x h
cm 56 x 124 x 110 h

Volume
0,325 m³

Weight
22 kg

Bag capacity
2 x 22 l

COMPOSITION	CODE	DIGIT	UNIT PRICE
BASE WITH 4 RUBBER WHEELS Ø 100 MM (METAL FORK)	PMVR95743	● 0006	€ 80,60
VARNISHED SUPPORT (WITH LATERAL HOLES)	PMLA96081	● 0006	€ 18,70
FIBREGLASS SUPPORT FOR ACCESSORIES WITH DOVETAIL JOINT	MPVR94773	● 0006	€ 7,45
DOUBLE POLYPROPYLENE SUPPORT FOR 2X70 LT. BAG COMPLETE OF LATERAL REINFORCING SUPPORTS	PMVR95753	● 0006	€ 23,25
POLYPROPYLENE SUPPORT FOR TRAY	MPVR94617	● 0006	€ 7,15
FIBREGLASS SUPPORT FOR TRAY	MPVR94616	● 0006	€ 7,35
POLYPROPYLENE TRAY	MPVR94560	● 0006	€ 9,45
HANDLE HOLDER	PMVR95640	● 0006	€ 3,70
22 LT. POLYPROPYLENE BUCKET	SECC70027	● NNB6 ● NNR6	€ 13,20
LID FOR 22 LT. BUCKET	● SECC70002 ● SECC70003		€ 6,80
VARNISHED SUPPORT FOR 22 LT. BUCKET	LAGR99703	-	€ 31,30
BLOCKING PINS FOR 22 LT. BUCKET (COUPLE)	MPVR99758	-	€ 5,50
6 LT. BUCKET	SECC00056	● 0615 ● 0618 ● 0617 ● 0604	€ 6,60
MOP SUPPORT	MPVR94615	● 0006	€ 5,90
COVER FOR BASE	MPVR94704	● 0006	€ 0,51
NYLON COVER	MPVR94584	● 0009	€ 1,02

ACCESSORIES

70 LT. PLASTICIZED BAG WITH RUBBER BAND	SACC00036	● 0005 ● 0002	€ 34,50
---	-----------	------------------	---------

LID FOR 2X70 LT. BAG SUPPORT
Optional

STARACE 113

CODE
CARR00088

UNIT PRICE
€ 131,70



TECHNICAL DATA

Support
VARNISHED

Trolley dimensions
(x L x h)
cm 56 x 45 x 93 h

Volume
0,290 m³

Weight
7,5 kg

Bag capacity
2 x 22 l

COMPOSITION	CODE	DIGIT	UNIT PRICE
VARNISHED FRAME	LAFN99610	-	€ 87,90
FIXED Ø 175 MM. RUBBER WHEEL (POLYPROPYLENE HUB)	RTRT00563	● 0606	€ 8,05
22 LT. POLYPROPYLENE BUCKET	SECC70027	● NNB6 ● NNR6	€ 13,20
LID FOR 22 LT. BUCKET	● SECC70002 ● SECC70003		€ 6,80

ANTARES A

WITH NEW LINE WRINGER
CODE
CARR00378

UNIT PRICE
€ 444,90

WITH KINETIC WRINGER
CODE
CARR50378

UNIT PRICE
€ 460,00

● IP06 ● IP15



TECHNICAL DATA

Support
ALUMINIUM

Trolley dimensions
L x L x h
cm 113 x 51,5 x 100 h

Volume
0,325 m³

Weight
26 kg

Bag capacity
120 l

COMPOSITION	CODE	DIGIT	UNIT PRICE
BASE WITH 4 RUBBER WHEELS Ø 125 MM (NYLON FORK)	PMVR95576	● 0006	€ 107,20
718 MM. ALUMINIUM LATERAL SUPPORT TYPE 2 WITH CLIP FIXING REINFORCING SUPPORT (FOR BAG SUPPORT AND TRAYS)	PRAL00027	● 0006	€ 31,90
718 MM. ALUMINIUM LATERAL SUPPORT TYPE 3 (FOR WRINGER SUPPORT AND TRAYS)	PRAL00035	● 0006	€ 31,90
SUPPORT FOR 120 LT. BAG (COMPLETE WITH CLIP FIXING BAG AND LATERAL REINFORCING SUPPORTS)	PMVR95769	● 0006	€ 27,20
120 LT. POLYPROPYLENE LID	MPVR94593	● 0006	€ 10,50
POLYPROPYLENE BASE FOR BAG WITH Ø125 MM. RUBBER WHEEL (NYLON FORK)	PMVR95583	● 0006	€ 41,30
POLYPROPYLENE TRAY TYPE 2	MPVR94595	● 0006	€ 13,90
6 LT. BUCKET	SECC00056	● 0615 ● 0618 ● 0617 ● 0604	€ 6,60
15 LT. BUCKET	SECC00055	● 0615 ● 0618	€ 13,90
FIBREGLASS WRINGER SUPPORT WITH CONNECTION FOR LATERAL SUPPORT	MPVR94588	● 0006	€ 31,40
NEW LINE/STRONG WRINGER	STRI00030	● IP15	€ 54,90
HANDLE HOLDER	PMVR95781	● 0006	€ 5,00
MOP SUPPORT	MPVR94599	● 0006	€ 5,30
HOLDER FOR TOOLS	PMVR95784	● 0006	€ 5,00
NYLON STOPPER FOR BASE	MPVR94580	● 0006	€ 0,82
NYLON COVER FOR LATERAL SUPPORT	MPVR94584	● 0009	€ 1,02
KINETIC WRINGER	STRI00072	● IP09	€ 70,00

BAG 120 LT. Optional

MAIN ACCESSORIES / OPTIONALS

FLEXIBLE WATER PIPE FOR FILLING BUCKETS

CODE
TBBP00516



LID FOR 120 LT. BAG SUPPORT

CODE
MPVR94593 - 0006



120 LT. BAG

CODE
SACC00008

● 0005
● 0002



6 LT. BUCKETS

CODE
SECC00056

● 0615
● 0618
● 0617
● 0604



MULTILINGUAL SAFETY SIGN

CODE
CART00026



For trolleys without wringers subtract € 25.00 from the list price

ANTARES B

WITH NEW LINE WRINGER
CODE
CARR00121

UNIT PRICE
€ 349,00

WITH KINETIC WRINGER
CODE
CARR50121

UNIT PRICE
€ 364,10

● IP06 ● IP15



TECHNICAL DATA

Support
ALUMINUM

Trolley dimensions
L x L x h
cm 82 x 51,5 x 100 h

Volume
0,217 m³

Weight
20,5 kg

Bag capacity
120 L

COMPOSITION	CODE	DIGIT	UNIT PRICE
BASE WITH 4 RUBBER WHEELS Ø 125 MM (NYLON FORK)	PMVR95576	● 0006	€ 107,20
718 MM. ALUMINIUM LATERAL SUPPORT TYPE 1 WITH CLIP FIXING REINFORCING SUPPORT (FOR BAG AND WRINGER SUPPORT)	PRAL00028	● 0006	€ 32,90
POLYPROPYLENE SUPPORT FOR 120 LT. BAG (COMPLETE WITH CLIP FIXING BAG AND LATERAL REINFORCING SUPPORT)	PMVR95769	● 0006	€ 27,20
120 LT. POLYPROPYLENE LID	MPVR94593	● 0006	€ 10,50
POLYPROPYLENE TRAY TYPE 3	MPVR94602	● 0006	€ 10,30
POLYPROPYLENE SUSTAINING SUPPORT FOR BAG/TRAY	MPVR94590	● 0006	€ 5,70
6 LT. BUCKET	SECC00056	● 0615 ● 0618	€ 6,60
15 LT. BUCKET	SECC00055	● 0615 ● 0618	€ 13,90
FIBREGLASS WRINGER SUPPORT WITH CONNECTION FOR LATERAL SUPPORT	MPVR94588	● 0006	€ 31,40
NEW LINE/STRONG WRINGER	STRI00030	● IP15	€ 54,90
HANDLE HOLDER	PMVR95781	● 0006	€ 5,00
MOP SUPPORT	MPVR94599	● 0006	€ 5,30
HOLDER FOR TOOLS	PMVR95784	● 0006	€ 5,00
NYLON STOPPER FOR BASE	MPVR94580	● 0006	€ 0,82
NYLON COVER FOR LATERAL SUPPORT	MPVR94584	● 0009	€ 1,02
KINETIC WRINGER	STRI00072	● IP09	€ 70,00

BAG 120 LT. Optional

MAIN ACCESSORIES / OPTIONALS

FLEXIBLE WATER PIPE FOR FILLING BUCKETS

CODE
TBBP00516



SAFETY SIGN HOLDER

CODE
PMVR95642 - 0006



120 LT. BAG

CODE
SACC00008

● 0005
● 0002



6 LT. BUCKETS

CODE
SECC00056

● 0615
● 0618
● 0617
● 0604



MULTILINGUAL SAFETY SIGN

CODE
CART00026



For trolleys without wringers subtract € 25.00 from the list price

ANTARES SECURITY A

WITH NEW LINE WRINGER
CODE
CARR00449

UNIT PRICE
€ 591,30

WITH KINETIC WRINGER
CODE
CARR50449

UNIT PRICE
€ 606,40

● IP06 ● IP15



TECHNICAL DATA

Support
ALUMINIUM

Trolley dimensions
L x L x h
cm 124,5 x 68 x 118 h

Volume
0,519 m³

Weight
32,5 kg

Bag capacity
120 l

COMPOSITION	CODE	DIGIT	UNIT PRICE
BASE WITH 4 RUBBER WHEELS Ø 125 MM (NYLON FORK)	PMVR95576	● 0006	€ 107,20
718 MM. ALUMINIUM LATERAL SUPPORT TYPE 8	PRAL00042	● 0006	€ 36,35
718 MM. ALUMINIUM LATERAL SUPPORT TYPE 9	PRAL00043	● 0006	€ 36,35
POLYPROPYLENE SUPPORT FOR 120 LT. BAG (COMPLETE WITH CLIPS FIXING BAG)	PMVR95589	● 0006	€ 37,40
120 LT. POLYPROPYLENE LID	MPVR94593	● 0006	€ 10,50
POLYPROPYLENE BASE FOR BAG WITH Ø125 MM. RUBBER WHEEL (NYLON FORK)	PMVR95583	● 0006	€ 41,30
POLYPROPYLENE TRAY	MPVR94607	● 0006	€ 27,40
6 LT. BUCKET	SECC00056	● 0615 ● 0618 ● 0617 ● 0604	€ 6,60
15 LT. BUCKET	SECC00055	● 0615 ● 0618 ● 0609 ● 0620	€ 13,90
FIBREGLASS WRINGER SUPPORT WITH CONNECTION FOR LATERAL SUPPORT	MPVR94588	● 0006	€ 31,40
NEW LINE/STRONG WRINGER	STRI00030	● IP15	€ 54,90
MOP SUPPORT	MPVR94599	● 0006	€ 5,30
HANDLE HOLDER	PMVR95637	● 0006	€ 1,12
ABS BAG PROTECTION PANEL (BACK, HALF PART)	MPVR94626	● 0006	€ 59,20
ABS CABINET LATERAL PANEL	MPVR94627	● 0006	€ 18,60
ABS BAG PROTECTING PIVOTING PANEL (FRONT, HALF PART) COMPLETE WITH FIXING HOOK	PMVR95785	● 0009	€ 32,90
ABS CABINET DOOR WITH LOCK AND KEY	PMVR95786	● 0009	€ 50,65
SPACER FOR LATERAL PANEL	MPVR94609	● 0006	€ 1,63
POLYPROPYLENE WRITING-DESK	MPVR94608	● 0006	€ 13,30
LINKING PIN FOR PANELS AND DOORS	MPVR94610	● 0006	€ 0,31
NYLON STOPPER FOR BASE	MPVR94580	● 0006	€ 0,82
NYLON COVER FOR LATERAL SUPPORT	MPVR94584	● 0009	€ 1,02
KINETIC WRINGER	STRI00072	● IP09	€ 70,00

For trolleys without wringers subtract € 25,00 from the list price

STARACE COMPONENTS & ACCESSORIES

POLYPROPYLENE BASE WITH 4 RUBBER WHEELS Ø 100 MM (METAL FORK)

CODE
PMVR95743 - 0006
UNIT PRICE
€ 80,60



POLYPROPYLENE BASE WITH 2 RUBBER WHEELS Ø 100 MM. (NYLON FORK) AND 2 RUBBER WHEELS Ø 175 MM. (POLYPROPYLENE HUB)

CODE
PMVR95747 - 0006
UNIT PRICE
€ 107,70



POLYPROPYLENE BASE WITH 4 RUBBER WHEELS Ø 100 MM (METAL FORK)

CODE
PMVR95750 - 0006
UNIT PRICE
€ 68,10



POLYPROPYLENE BASE FOR BAG COMPLETE WITH Ø 50 MM RUBBER WHEEL (NYLON FORK)

CODE
PMVR95776 - 0006
UNIT PRICE
€ 17,50



RUBBER WHEEL Ø 80 MM (NYLON FORK) 10X25 CM

CODE
RTRT00566 - 0006
UNIT PRICE
€ 6,50



RUBBER WHEEL Ø 100 MM (METAL FORK)

CODE
RTRT00725
UNIT PRICE
€ 9,85



RUBBER WHEEL Ø 100 MM WITH BRAKE (METAL FORK)

CODE
RTRT99645
UNIT PRICE
€ 13,10



RUBBER WHEEL Ø 100 MM (NYLON FORK) - STARACE

CODE
RTRT00763
UNIT PRICE
€ 15,25



RUBBER WHEEL Ø 125 MM (NYLON FORK) - STARACE

CODE
RTRT00759
UNIT PRICE
€ 17,50



RUBBER WHEEL Ø 125 MM WITH BRAKE (NYLON FORK) - STARACE

CODE
RTRT00760
UNIT PRICE
€ 20,90



FIXED Ø 175 MM RUBBER WHEEL (POLYPROPYLENE HUB)

CODE
RTRT00563 - 0606
UNIT PRICE
€ 8,05



POLYPROPYLENE COVER FOR BASE

CODE
MPVR94704 - 0006
UNIT PRICE
€ 0,51



NYLON COVER

CODE
MPVR94584 - 0009
UNIT PRICE
€ 1,02



**VARNISHED SUPPORT
WITH LATERAL HOLES**

CODE
PMLA96081 - 0006
UNIT PRICE
€ 18,70



**VARNISHED SUPPORT
WITH FRONTAL HOLES**

CODE
PMLA96096 - 0006
UNIT PRICE
€ 18,70



**VARNISHED SUPPORT
FOR WRINGER (25 LT. BUCKET)**

CODE
PMLA96085 - 0006
UNIT PRICE
€ 16,25



**VARNISHED SUPPORT
FOR TROLLEYS STARACE 108-109**

CODE
PMLA96086 - 0006
UNIT PRICE
€ 19,60



**VARNISHED SUPPORT TYPE 3
FOR STARACE 110**

CODE
PMLA96078 - 0006
UNIT PRICE
€ 25,00



**VARNISHED SUPPORT TYPE 4
FOR STARACE 111**

CODE
PMLA96079 - 0006
UNIT PRICE
€ 21,95



**RILSAN SUPPORT
WITH LATERAL HOLES**

CODE
LAFN99624
UNIT PRICE
€ 12,05



**RILSAN BAR
FOR LAFN99624**

CODE
LAFN99614
UNIT PRICE
€ 9,75



**VARNISHED SUPPORT
FOR WRINGER (15 LT. BUCKET)**

CODE
PMLA96082 - 0006
UNIT PRICE
€ 16,45



**POLYPROPYLENE CLIP
FOR SUPPORT**

CODE
MPVR94752 - 0006
UNIT PRICE
€ 0,82



**CLIP FOR BAG HOLDER
REINFORCING BAR**

CODE
MPVR94749 - 0006
UNIT PRICE
€ 1,02



**FIBREGLASS SUPPORT
FOR ACCESSORIES WITH DOVETAIL JOINT**

CODE
PMVR95653 - 0006
UNIT PRICE
€ 8,05

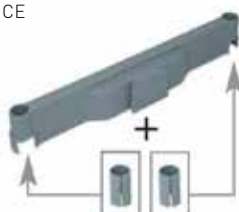

**FIBREGLASS SUPPORT
FOR ACCESSORIES WITH DOUBLE DOVETAIL JOINT**

CODE
PMVR95654 - 0006
UNIT PRICE
€ 9,55

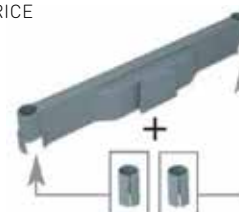

KIT COMPLETE

WITH 120 LT. BAG SUPPORT, TRAY FOR TOOLS, LID (LOCKABLE WITH PLASTIC KEY) AND LATERAL REINFORCING SUPPORTS

CODE
PMVR95758 - 0006
UNIT PRICE
€ 49,50



KIT COMPLETE

WITH 2X70 LT. BAG SUPPORT, TRAY FOR TOOLS, LID (LOCKABLE WITH PLASTIC KEY) AND LATERAL REINFORCING SUPPORTS

CODE
PMVR95754 - 0006
UNIT PRICE
€ 54,90



120 LT. COMPLETE ERGONOMIC BAG SUPPORT

CODE
MPVR94522 - 0006
UNIT PRICE
€ 11,00



120 LT. ERGONOMIC BAG SUPPORT

(COMPLETE WITH CLIP FIXING BAG AND LATERAL REINFORCING SUPPORTS)

CODE
PMVR95752 - 0006
UNIT PRICE
€ 21,20



2X70 LT. COMPLETE ERGONOMIC BAG SUPPORT

CODE STANDARD
PMVR95604 - 0006
UNIT PRICE
€ 13,05



2X70 LT. ERGONOMIC BAG SUPPORT

(COMPLETE WITH CLIP FIXING BAG AND LATERAL REINFORCING SUPPORTS)

CODE
PMVR95753 - 0006
UNIT PRICE
€ 23,25



3X40 LT. COMPLETE ERGONOMIC BAG SUPPORT

CODE
PMVR06379 - 0006
UNIT PRICE
€ 117,60



LATERAL POLYPROPYLENE REINFORCING SUPPORTS (COUPLE)

CODE
MPVR94631 - 0006
UNIT PRICE
€ 10,20



POLYPROPYLENE CLIP FIXING BAG

CODE
MPVR94633 - 0006
UNIT PRICE
€ 1,02



TRIPLE METAL BAG SUPPORT 3X40 LT.

CODE
COME00319
UNIT PRICE
€ 108,70



FIBREGLASS SUPPORT FOR TRAY MPVR94560 - 0006

CODE
MPVR94616 - 0006
UNIT PRICE
€ 7,35



120 LT. POLYPROPYLENE LID

CODE
MPVR94593 - 0006
UNIT PRICE
€ 10,50



120 LT. PLASTICIZED BAG WITH HOOK AND LOOP FASTENERS

CODE
SACC00008

● 0005 ● 0002



UNIT PRICE
€ 44,70

120 LT. PLASTICIZED BAG WITH FRONT OPENING

CODE
SACC00034

● 0005 ● 0002
● 0003 ● 0004
● 0006



UNIT PRICE
€ 47,40

70 LT. PLASTICIZED BAG WITH STRING

CODE
SACC00036

● 0005 ● 0002



UNIT PRICE
€ 34,50

40 LT. BAG WITH STRING FOR ANTARES

CODE
SACC00061

● 0005 ● 0002
● 0009 ● 0004



UNIT PRICE
€ 32,00

POLYPROPYLENE SUPPORT FOR MOP

CODE
MPVR94615 - 0006



UNIT PRICE
€ 5,90

POLYPROPYLENE SUPPORT FOR MOP

CODE
MPVR94599

● 0015 ● 0010
● 0009 ● 0004
● 0006



UNIT PRICE
€ 5,30

HANDLE HOLDER

CODE
PMVR95640 - 0006

UNIT PRICE
€ 3,70



HANDLE HOLDER

CODE
PMVR95637 - 0006

UNIT PRICE
€ 1,12



RUBBER HANDLE HOLDER

CODE
PMVR95806

UNIT PRICE
€ 7,35



HOLDER FOR TOOLS

CODE
PMVR95641 - 0006

UNIT PRICE
€ 4,30



SAFETY SIGN HOLDER

CODE
PMVR95642 - 0006

UNIT PRICE
€ 5,40



POLYPROPYLENE SWIVEL SUPPORT

FOR 6 LT. BUCKET

CODE
PMVR95756

UNIT PRICE
€ 8,85



6 LT. POLYPROPYLENE BUCKET

CODE
SECC00056

● 0615 ● 0602
● 0617 ● 0604

UNIT PRICE
€ 6,60



POLYPROPYLENE LID

FOR 6 LT. BUCKET WITH CLOSURE

CODE
MPVR10854 - 0008

UNIT PRICE
€ 5,90



9 LT. POLYPROPYLENE BUCKET

CODE
SECC00054

● 0615 ● 0602 ● 0603
● 0618 ● 0604

UNIT PRICE
€ 7,25



15 LT. POLYPROPYLENE BUCKET

CODE
SECC00055

● 0615 ● 0602 ● 0609
● 0620 ● 0618

UNIT PRICE
€ 13,90



12+18 LT. POLYPROPYLENE BUCKET

CODE
SECC00065

● 0015 ● 0002
● 0009 ● 0004

UNIT PRICE
€ 27,40



FIBREGLASS SUPPORT

FOR WRINGER FOR SECC00065

CODE
MPVR94664 - 0006

UNIT PRICE
€ 6,80



35 LT. POLYPROPYLENE BASIN

CODE
MPVR94597 - 0018

UNIT PRICE
€ 28,90



POLYPROPYLENE SIEVE

FOR 35 LT. BASIN

CODE
MPVR94598 - 0015

UNIT PRICE
€ 11,30



VARNISHED BLOCKING TUBE

FOR 35 LT. BASIN

CODE
PMLA96084 - 0006

UNIT PRICE
€ 6,50



POLYPROPYLENE TRAY

TYPE 3

CODE
MPVR94602 - 0006
UNIT PRICE
€ 10,30



POLYPROPYLENE TRAY

CODE
MPVR94603 - 0006
UNIT PRICE
€ 7,35



POLYPROPYLENE TRAY

CODE
MPVR94560 - 0006
UNIT PRICE
€ 9,45



POLYPROPYLENE SMALL TRAY

CODE
MPVR94559 - 0006
UNIT PRICE
€ 5,50



RILSAN SUPPORT FOR TRAY FOR MPVR94602 - 0006

CODE
LAFN99613
UNIT PRICE
€ 11,00



POLYPROPYLENE PAPER ROLL HOLDER

CODE
POCA00006 - 0006
UNIT PRICE
€ 18,00



FIBREGLASS PUSHING HANDLE

CODE
MPVR94594 - 0006
UNIT PRICE
€ 7,45



COMPLETE POLYPROPYLENE BOARD

CODE
PMVR95761 - 0006
UNIT PRICE
€ 24,40



FLEXIBLE WATER PIPE FOR FILLING BUCKETS

CODE
TBBP00516
UNIT PRICE
€ 18,20



ANTARES

COMPONENTS & ACCESSORIES

POLYPROPYLENE BASE WITH 4 RUBBER WHEELS Ø 125 MM (NYLON FORK)

CODE
PMVR95576 - 0006

UNIT PRICE
€ 107,20



NYLON STOPPER FOR BASE

CODE
MPVR94580 - 0006

UNIT PRICE
€ 0,82



NYLON COVER FOR LATERAL SUPPORT

CODE
MPVR94584 - 0009

UNIT PRICE
€ 1,02



REINFORCEMENT CAP FOR WHEEL

CODE
MPVR94605 - 0006

UNIT PRICE
€ 1,43

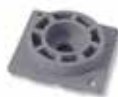

REINFORCEMENT HOLE-COVER INSERT FOR BASE

CODE
MPVR94606 - 0006

UNIT PRICE
€ 1,53



LOCKING LEVER FOR BASE

CODE
MPVR94604 - 0006

UNIT PRICE
€ 0,82



POLYPROPYLENE BASE FOR BAG WITH RUBBER WHEEL Ø 125 MM (NYLON FORK)

CODE
PMVR95583 - 0006

UNIT PRICE
€ 41,30



POLYPROPYLENE BASE FOR BAG WITH 2 RUBBER WHEELS Ø 125 MM (NYLON FORK)

CODE
PMVR95770 - 0006

UNIT PRICE
€ 57,70



POLYPROPYLENE BASE FOR BAG WITH RUBBER WHEEL Ø 100 MM (NYLON FORK)

CODE
PMVR95772 - 0006

UNIT PRICE
€ 38,40



POLYPROPYLENE BASE FOR BAG WITH 2 RUBBER WHEELS Ø 100 MM (NYLON FORK)

CODE
PMVR95616 - 0006

UNIT PRICE
€ 42,40



RUBBER WHEEL Ø 100 MM
(METAL FORK)

CODE
RTRT00725
UNIT PRICE
€ 9,85



RUBBER WHEEL Ø 100 MM
(METAL FORK) WITH BRAKE

CODE
RTRT99645
UNIT PRICE
€ 13,10



RUBBER WHEEL Ø 125 MM
(METAL FORK)

CODE
RTRT99650
UNIT PRICE
€ 11,00



RUBBER WHEEL Ø 100 MM
(NYLON FORK) - STARACE

CODE
RTRT00761
UNIT PRICE
€ 15,25



RUBBER WHEEL Ø 100 MM
(NYLON FORK) FOR ANTARES BASE FOR BAG

CODE
RTRT00762
UNIT PRICE
€ 15,25



RUBBER WHEEL Ø 125 MM
(NYLON FORK) - ANTARES

CODE
RTRT00754
UNIT PRICE
€ 17,50



RUBBER WHEEL Ø 125 MM
(NYLON FORK) WITH BRAKE ANTARES

CODE
RTRT00755
UNIT PRICE
€ 20,90



RUBBER WHEEL Ø 125 MM
(NYLON FORK) FOR ANTARES BASE FOR BAG

CODE
RTRT00758
UNIT PRICE
€ 17,50



RUBBER WHEEL Ø 150 MM
(NYLON FORK)

CODE
RTRT00561
UNIT PRICE
€ 32,30



718 MM ALUMINUM
LATERAL SUPPORT TYPE 1
WITH CLIP FIXING REINFORCING SUPPORT
(FOR BAG AND WRINGER SUPPORT)

CODE
PRAL00028 - 0006
UNIT PRICE
€ 32,90



718 MM ALUMINUM
LATERAL SUPPORT TYPE 2
(FOR BAG SUPPORT AND TRAYS)

CODE
PRAL00026 - 0006
UNIT PRICE
€ 31,90



718 MM ALUMINUM
LATERAL SUPPORT TYPE 2
WITH CLIP FIXING REINFORCING SUPPORT (FOR
BAG SUPPORT AND TRAYS)

CODE
PRAL00027 - 0006
UNIT PRICE
€ 31,90



718 MM ALUMINUM
LATERAL SUPPORT TYPE 3
(FOR WRINGER SUPPORT AND TRAYS)

CODE
PRAL00035 - 0006
UNIT PRICE
€ 31,90



705 MM FIBREGLASS
LATERAL SUPPORT TYPE 2
(FOR BAG SUPPORT AND TRAYS)

CODE
MPVR94523 - 0006
UNIT PRICE
€ 17,00



705 MM FIBREGLASS
LATERAL SUPPORT TYPE 3
(FOR BAG AND WRINGER SUPPORT)

CODE
MPVR94524 - 0006
UNIT PRICE
€ 17,50



WRENCH
FOR RUBBER WHEEL

CODE
AZPR00496
UNIT PRICE
€ 8,25



**718 MM ALUMINUM
LATERAL SUPPORT
TYPE 8**

CODE
PRAL00042 - 0006

UNIT PRICE
€ 36,35



**718 MM ALUMINUM
LATERAL SUPPORT
TYPE 9**

CODE
PRAL00043 - 0006

UNIT PRICE
€ 36,35



**POLYPROPYLENE SUPPORT
FOR 120 LT. BAG
(COMPLETE WITH CLIP FIXING BAG)**

CODE
PMVR95589 - 0006

UNIT PRICE
€ 37,40



**POLYPROPYLENE SUPPORT
FOR 120 LT. BAG
(COMPLETE WITH CLIP FIXING BAG AND
LATERAL REINFORCING SUPPORT)**

CODE
PMVR95769 - 0006

UNIT PRICE
€ 27,20



**POLYPROPYLENE SUPPORT
FOR 120 LT. BAG WITH ERGONOMIC HANDLE**

CODE
MPVR94522 - 0006

UNIT PRICE
€ 11,00



**DOUBLE POLYPROPYLENE
SUPPORT
FOR 2X70 LT. BAG**

CODE
PMVR95604 - 0006

UNIT PRICE
€ 13,05



**DOUBLE POLYPROPYLENE
SUPPORT
FOR 2X70 LT. BAG
(COMPLETE WITH CLIP FIXING BAG AND
LATERAL REINFORCING SUPPORT)**

CODE
PMVR95777 - 0006

UNIT PRICE
€ 34,40



**POLYPROPYLENE CLIP
FIXING BAG**

CODE
MPVR94633 - 0006

UNIT PRICE
€ 1,02



**OPEN BOTTOM SIDE BAG
HOLDER CONTAINER
WITH LID**

CODE
PMVR95821 - 0006

UNIT PRICE
€ 46,20



**2X35 LT. RILSAN
DOUBLE BAG SUPPORT**

CODE
LAGR99716

UNIT PRICE
€ 21,95



**LATERAL POLYPROPYLENE
REINFORCING SUPPORT**

CODE
MPVR94630 - 0006

UNIT PRICE
€ 5,50



120 LT. POLYPROPYLENE LID

CODE
MPVR94593 - 0006

UNIT PRICE
€ 10,50



**KIT COMPLETE
WITH 120 LT. BAG SUPPORT, TRAYS FOR TOOLS,
LID (LOCKABLE WITH PLASTIC KEY) AND
LATERAL REINFORCING SUPPORT**

CODE
PMVR95658 - 0006

UNIT PRICE
€ 49,50



**POLYPROPYLENE
DEODORANT HOLDER**

CODE
MPVR94629 - 0006

UNIT PRICE
€ 1,12



6 LT. POLYPROPYLENE BUCKET

CODE
SECC00056

- 0615 ● 0602
- 0617 ● 0604

UNIT PRICE
€ 6,60



POLYPROPYLENE LID
FOR 6 LT. BUCKET WITH CLOSURE

CODE
MPVR10854 - 0008

UNIT PRICE
€ 5,90



9 LT. POLYPROPYLENE BUCKET

CODE
SECC00054

- 0615 ● 0602 ● 0617
- 0618 ● 0604

UNIT PRICE
€ 7,25



15 LT. POLYPROPYLENE BUCKET

CODE
SECC00055

- 0615 ● 0602 ● 0609
- 0620 ● 0618

UNIT PRICE
€ 13,90



12+18 LT. POLYPROPYLENE BUCKET

CODE
SECC00065

- 0015 ● 0002
- 0009 ● 0004

UNIT PRICE
€ 27,40



FIBREGLASS SUPPORT
FOR WRINGER FOR SECC00065

CODE
MPVR94664 - 0006

UNIT PRICE
€ 6,80



35 LT. POLYPROPYLENE BASIN

CODE
MPVR94597 - 0018

UNIT PRICE
€ 29,35



POLYPROPYLENE SIEVE
FOR 35 LT. BASIN

CODE
MPVR94598 - 0015

UNIT PRICE
€ 11,30



POLYPROPYLENE TRAY

CODE
MPVR94603 - 0006

UNIT PRICE
€ 7,35



POLYPROPYLENE TRAY
TYPE 2

CODE
MPVR94595 - 0006

UNIT PRICE
€ 13,90



POLYPROPYLENE TRAY
TYPE 3

CODE
MPVR94602 - 0006

UNIT PRICE
€ 10,30



ABS ALL CLOSED TRAY
WITH GUIDES FOR DRAWER

CODE
MPVR94607 - 0006

UNIT PRICE
€ 27,40



ABS ONE SIDE OPEN TRAY
WITH GUIDES FOR DRAWER

CODE
MPVR94611 - 0006

UNIT PRICE
€ 28,55



ABS ALL CLOSED TRAY
WITH GUIDES FOR DRAWER

CODE
PMVR95605 - 0006

UNIT PRICE
€ 47,20

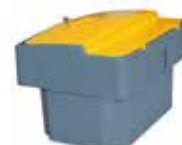

20 LT. POLYPROPYLENE DRAWER

CODE
MPVR94612 - 0006
UNIT PRICE
€ 9,95



POLYPROPYLENE LID

CODE
MPVR94624 - 0006
UNIT PRICE
€ 6,00



POLYPROPYLENE PERFORATED LID

CODE
MPVR94625 - 0006
UNIT PRICE
€ 5,50



POLYPROPYLENE DIVIDER FOR DRAWER

CODE
MPVR94623 - 0006
UNIT PRICE
€ 4,50



5 LT. POLYPROPYLENE BUCKET

CODE
SECC00015

● 1506 ● 0206
● 0906 ● 0406

UNIT PRICE
€ 8,85



POLYPROPYLENE LID FOR 5 LT. BUCKET

CODE
MPVR94358 - 0070

UNIT PRICE
€ 2,75



POLYPROPYLENE SUPPORT FOR MOP

CODE
MPVR94599 - 0006
UNIT PRICE
€ 5,30



HANDLE HOLDER

CODE
PMVR95644 - 0006
UNIT PRICE
€ 5,00



HANDLE HOLDER SECURITY

CODE
PMVR95637 - 0006
UNIT PRICE
€ 1,12



HOLDER FOR TOOLS

CODE
PMVR95784 - 0006
UNIT PRICE
€ 5,00



HOLDER FOR TOOLS SECURITY

CODE
PMVR95803 - 0006
UNIT PRICE
€ 5,00



SAFETY SIGN HOLDER

CODE
PMVR95645 - 0006
UNIT PRICE
€ 5,30



SAFETY SIGN HOLDER SECURITY

CODE
PMVR95804 - 0006
UNIT PRICE
€ 5,10



35 LT. PLASTICIZED BAG WITH DRAWSTRING

CODE
SACC00038

● 0025 ● 0002



UNIT PRICE
€ 31,90

70 LT. PLASTICIZED BAG WITH STRING

CODE
SACC00036

● 0005 ● 0002



UNIT PRICE
€ 34,50

120 LT. PLASTICIZED BAG WITH HOOK AND LOOP FASTENERS

CODE
SACC00008

● 0005 ● 0002



UNIT PRICE
€ 44,70

120 LT. PLASTICIZED BAG WITH FRONT OPENING

CODE
SACC00034 - 0006

UNIT PRICE
€ 47,40



FIBREGLASS WRINGER SUPPORT (WITH CONNECTION FOR LATERAL SUPPORT)

CODE
MPVR94588 - 0006

UNIT PRICE
€ 31,40



POLYPROPYLENE PAPER ROLL HOLDER (ROLL CAPACITY: 60 M - Ø 145 MM - H 225 M)

CODE
POCA00006 - 0006

UNIT PRICE
€ 18,00



FIBREGLASS PUSHING HANDLE

CODE
MPVR94594 - 0006

UNIT PRICE
€ 7,45



FLEXIBLE WATER PIPE FOR FILLING BUCKETS

CODE
TBBP00516

UNIT PRICE
€ 18,20



ABS BAG PROTECTION SECURITY PANEL (BACK, HALF PART)

CODE
MPVR94626 - 0006

UNIT PRICE
€ 59,20



ABS CABINET LATERAL PANEL SECURITY

CODE
MPVR94627 - 0006

UNIT PRICE
€ 18,60



ABS BAG PROTECTION PIVOTING PANEL (FRONTAL, HALF PART) COMPLETE WITH FIXING HOOK SECURITY

CODE
PMVR95785 - 0009

UNIT PRICE
€ 32,90



ABS CABINET DOOR WITH LOCK AND KEY SECURITY

CODE
PMVR95786 - 0009

UNIT PRICE
€ 50,65



SPACER FOR LATERAL PANEL SECURITY

CODE
MPVR94609 - 0006

UNIT PRICE
€ 1,63



POLYPROPYLENE WRITING-DESK SECURITY

CODE
MPVR94608 - 0006

UNIT PRICE
€ 13,30



LINKING PIN FOR PANES AND DOORS SECURITY

CODE
MPVR94610 - 0006

UNIT PRICE
€ 0,31



OTHERS
TROLLEYS
ACCESSORIES

CADDY TRAY COMPLETE
FOR TOOLS

CODE
KTRI06032

UNIT PRICE
€ 27,80



POLYPROPYLENE CADDY
FOR TOOLS

CODE
MPVR94375 - 0006

UNIT PRICE
€ 13,40



POLYPROPYLENE TOILET
BRUSH/BOTTLE/TOOLS HOLDER
FOR MPVR94375

CODE
MPVR99755

UNIT PRICE
€ 5,50



POLYPROPYLENE
BOTTLES HOLDER
FOR MPVR94375

CODE
MPVR94376 - 0006

UNIT PRICE
€ 2,45



POLYPROPYLENE
BOTTLES-HOLDING
FOR MPVR94375

CODE
MPVR99754

UNIT PRICE
€ 2,30



KINETIC PLUS

CODE
STRI00072

● IP09 ● IP13

UNIT PRICE
€ 70,00



KINETIC VALUE

CODE
STRI00073

● IP09 ● IP13

UNIT PRICE
€ 60,00



HERO INNOVATIONS



EDT
ERGONOMIC
DESIGN
TOOL



MCS
MULTIFUNCTION
CONTROL
SYSTEM

MAIN FEATURES

ERGONOMIC HANDLE
FREE 360° ROTATION
DESIGNED FOR CORRECT POSTURE
MULTIFUNCTION
UNIVERSAL

APPLICATION FIELD

RETAIL
OFFICE / HORECA / HOSPITALITY
EDUCATION
PUBLIC GOVERNMENT
TRANSPORT HUB
HEALTHCARE

NEW LINE / STRONG

CODE
STRI00030

- IP15 ● IP02
- IP09 ● IP04

UNIT PRICE
€ 54,90



NEW LINE / STRONG PRESS IS UNIVERSAL.

With its enhanced background and jaws fiberglass, it drains all types of mops (kentucky and flat). Its structure makes it a practical and long lasting tool.

NEW LINE/STRONG ACCESSORIES:

MOUSSE SHIM

CODE
LAMU00005

UNIT PRICE
€ 8,85



PLASTIC SHIM

CODE
MPVR94369

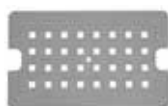

UNIT PRICE
€ 4,40

WITH MICROFIBER MOPS WE RECOMMEND THE USE OF SHIM.

SPEED / BOOK

CODE
STRI00003

- 0015 ● 0002
- 0009 ● 0004

UNIT PRICE
€ 49,50



SPEED / BOOK PRESS

is an horizontal press suitable for all types of mops.

SPEED/BOOK ACCESSORIES:

SHIM

CODE
LAMU00004

UNIT PRICE
€ 11,00



ROLLER / RULLY

CODE
STRI00007

- 0015 ● 0002
- 0009 ● 0004

UNIT PRICE
€ 98,90



ROLLER / RULLY PRESS

bottomless, has been studied for washing flat mops (ideal for microfiber mops). Its roll is soft and it is thought for wide working area to obtain uniform results. The automatic return of the handle ensures maximum comfort for the operator.

NEW LINE/STRONG WRINGER COMPONENTS

BODY WRINGER FOR NEW LINE/STRONG

CODE
MPVR94398 - 0006

UNIT PRICE
€ 12,70



LATERAL PROTECTION SET WITH SCREWS

CODE
KTRI06975

● IP15 ● IP02
● IP09 ● IP04

UNIT PRICE
€ 7,15



ALUMINUM WRINGER'S SUPPORT

CODE
KTRI06956

UNIT PRICE
€ 10,90



ALUMINUM HANDLE WITH GRIP AND CLIPS FIXATION HANDLE

CODE
MANI00038 - 0006

UNIT PRICE
€ 7,65



GRIP Ø 24 MM

CODE
MAN000002-0006

UNIT PRICE
€ 0,82



CLIP FIXATION HANDLE

CODE
MPVR94474

UNIT PRICE
€ 0,51



SPLASH GUARD

CODE
MPVR94748

● 0015 ● 0002
● 0009 ● 0004

UNIT PRICE
€ 2,35



PRESS BAR

CODE
MPVR94472

UNIT PRICE
€ 4,80



NYLON GEARS

CODE
KTRI06957

UNIT PRICE
€ 19,30



TORSION SPRING

CODE
MOLL00002

UNIT PRICE
€ 3,70



HANDLE HOLDER FOR WRINGER

CODE
MPVR94577 - 0006

UNIT PRICE
€ 1,93



SPEED/BOOK WRINGER COMPONENTS

BODY WRINGER FOR SPEED/BOOK

CODE
MPVR94399 - 0006



UNIT PRICE
€ 11,00

LATERAL PROTECTION SET WITH SCREWS

CODE
KTRI06979

● 0015 ● 0002
● 0009 ● 0004



UNIT PRICE
€ 3,60

FIBREGLASS PUSH PLATE WITH CAP AND CLIPS

CODE
KTRI06964



UNIT PRICE
€ 15,45

POLYPROPYLENE PRESSURE PLATE

CODE
MPVR94484 - 0006



UNIT PRICE
€ 6,70

FIBREGLASS SET SUPPORT FOR PLATES

CODE
KTRI06963



UNIT PRICE
€ 4,30

KIT SPRINGS AND CLOSING SYSTEM

CODE
KTRI06962



UNIT PRICE
€ 5,10

ALUMINUM HANDLE WITH GRIP AND CLIPS FIXATION HANDLE

CODE
MANI00040

● 0015 ● 0002
● 0009 ● 0004



UNIT PRICE
€ 8,35

CLIPS FIXATION HANDLE

CODE
MPVR94488 - 0006



UNIT PRICE
€ 0,51

GRIP Ø 22 MM

CODE
MAN000003

● 0015 ● 0002
● 0009 ● 0004



UNIT PRICE
€ 0,82

ROLLER/RULLY WRINGER COMPONENTS

BODY WRINGER FOR ROLLER/RULLY

CODE
MPVR94401 - 0006

UNIT PRICE
€ 20,40



LATERAL PROTECTION SET WITH SCREWS

CODE
KTRI06977

● 0015 ● 0002
● 0009 ● 0004

UNIT PRICE
€ 6,60



KIT WRINGER'S SUPPORT

CODE
KTRI06958

UNIT PRICE
€ 21,95



KIT PRESSURE PLATE WITH 2 PINS

CODE
KTRI06960

UNIT PRICE
€ 12,00



KIT ROLLER/RULLY WITH ALUMINUM SUPPORT FOR ROLLER, BUSHES AND CAP

CODE
KTRI06961

UNIT PRICE
€ 28,55



KIT COMPLETE WITH BUSHES, TORSION SPRING AND CAP

CODE
KTRI06959

UNIT PRICE
€ 5,10



ALUMINUM HANDLE WITH GRIP AND CLIPS FIXATION HANDLE

CODE
MANI00039 - 0006

UNIT PRICE
€ 8,55



CLIPS FIXATION HANDLE

CODE
MPVR94474

UNIT PRICE
€ 0,51



GRIP Ø 24 MM

CODE
MANO00002-0006

UNIT PRICE
€ 0,82



HANDLE HOLDER FOR WRINGER

CODE
MPVR94577 - 0006

UNIT PRICE
€ 1,93



FIXING KIT WITH SCREW

CODE
KTRI06966

UNIT PRICE
€ 1,83



MULTILINGUAL SAFETY SIGNS



	CODE	PCS/BOX	UNIT PRICE
MULTILINGUAL SAFETY SIGN	CART00026	5	€ 16,45
ENGLISH: "CAUTION WET FLOOR"	CART00012	5	€ 16,45
ENGLISH: "CLEANING IN PROGRESS"	CART00016	5	€ 16,45
ITALIAN: "ATTENZIONE PAVIMENTO BAGNATO"	CART00011	5	€ 16,45
DEUTSCH: "ACHTUNG RUTSCHGEFAHR"	CART00013	5	€ 16,45
ESPAÑOL: "ATENCIÓN PISO HUMEDO"	CART00014	5	€ 16,45
FRANCAIS: "ATTENTION SOL GLISSANT"	CART00015	5	€ 16,45
NEDERLANDS: "LEP OP! NATTE VLOER"	CART00018	5	€ 16,45
PORTOGUESE: "PAVIMENTO HÚMIDO"	CART00019	5	€ 16,45
RUSSIAN - русский: "ОСТОРОЖНО МОКРЫЙ ПОЛ"	CART00021	5	€ 16,45
CROATIAN: "POZOR KLIZAV POD!"	CART00023	5	€ 16,45
CATALAN: "ATENCIÓ! TERRA LLISCANT"	CART00020	5	€ 16,45
SAFETY SIGN WITHOUT SIGN	CART00017	5	€ 16,45

CHAIN FOR SAFETY SIGNS (2 M)

CODE
PMVR95648

SIZE
24 rings

UNIT PRICE
€ 4,90



SAFETY SIGNS EXTENSION

CODE
CART00024

PCS/BOX
1

UNIT PRICE
€ 5,00

EXTENSION SET
(2 PIECES)

CODE
CART00025

PCS/BOX
2

UNIT PRICE
€ 9,95



SAFETY SIGN POLE

CODE
CART00032

PCS/BOX
10

UNIT PRICE
€ 36,95



CLEANING TROLLEYS RANGE /

BRIX HOTEL

BENEFITS AND FEATURES



FOLDING BAG SUPPORT

- ▶ **Maximum compactness:** ideal in places where a small trolley is required without renouncing the complete service
- ▶ **Space saving:** allows a reduction of 210 mm of the overall dimensions of the bag holder
- ▶ **Strong:** guarantees solidity and robustness to the entire trolley



WHEELS

- ▶ **Maximum smoothness:** thanks to the ball bearings which means less effort from the operator while moving.
- ▶ **More accurate directionality:** the wheels support the direction to the trolley with little steering effort
- ▶ **Easy steering:** double ball bearing swivel head that considerably reduces the effort required by the operator
- ▶ **Quiet running:** thanks to the materials used and the high quality bearings that make the wheels silent on each surface
- ▶ **Low vibration:** soft compounds with good dampening properties
- ▶ **Non-staining and non-marking:** they do not stain on contact with floors during long standing periods



DOORS

- ▶ **Impact resistant:** withstands impact with blunt objects without damage
- ▶ **Resistant to wear:** their density makes them resistant to scratches
- ▶ **Resistant to light:** they do not suffer from UV ray damage and are not subject to discoloration
- ▶ **Heat-resistant:** temperature changes do not affect the properties
- ▶ **Antistatic:** do not attract dust on surface

BRIX HOTEL MINI 2.0

NEW



CODE
CARR02831 - IP99

UNIT PRICE
€ 707,50

TECHNICAL DATA

Trolley dimensions
l x L x h
mm 870 x 610 x 1550 h

Weight
30,0 Kg

BRIX HOTEL MINI 2.0 SMART
WITHOUT CLOSURE

CODE
CARR02995 - IP99

UNIT PRICE
€ 610,80

TECHNICAL DATA

Trolley dimensions
l x L x h
mm 870 x 610 x 1550 h

Weight
27,2 Kg

BRIX HOTEL MIDI 2.0



**FOLDABLE
BAG SUPPORT**

CODE
CARR02829 -IP99

UNIT PRICE
€ 914,70

TECHNICAL DATA

Trolley dimensions
l x L x h
mm 1660 x 610 x 1165 h

Weight
38 Kg

BRIX HOTEL MAXI 2.0



**FOLDABLE
BAG SUPPORT**

CODE
CARR02832 -IP99

UNIT PRICE
€ 1.030,40

TECHNICAL DATA

Trolley dimensions
l x L x h
mm 1660 x 610 x 1550 h

Weight
45 Kg

BRIX HOTEL MIDI 2.0 SMART WITHOUT CLOSURE

CODE
CARR02994 -IP99

UNIT PRICE
€ 764,50

TECHNICAL DATA

Trolley dimensions
l x L x h
mm 1660 x 610 x 1165 h

Weight
34,8 Kg

BRIX HOTEL MAXI 2.0 SMART WITHOUT CLOSURE

CODE
CARR02993 -IP99

UNIT PRICE
€ 862,60

TECHNICAL DATA

Trolley dimensions
l x L x h
mm 1660 x 610 x 1550 h

Weight
41,4 Kg

LAUNDRY TROLLEY 200 L

CODE
CARR00373 -0006

UNIT PRICE
€ 238,00



TECHNICAL DATA

Trolley dimensions
l x L x h
mm 850 x 520 x 1090 h

Weight
12 kg

Volume
0,177 m³

COMPOSITION	CODE	DIGIT	UNIT PRICE
BASE WITH 4 FIBERGLASS AND PP CASTORS Ø 125 MM WITH 2 WHEELS WITH BRAKE	PMVR95595	● 0006	€ 113,90
VARNISHED BRACKET WITH 2 BRUSHES Ø 22 MM	PMLA96096	● 0006	€ 18,70
BUSH FOR BRACKET	MPVR94772	● 0006	€ 1,32
VARNISHED SUPPORT FOR SHELF	PMLA96016		€ 9,25
200 LT. LAUNDRY BAG COMPLETE WITH HOOK AND LOOP FASTENERS	SACC00005	● 0006	€ 72,20
PLASTIC TOP FOR DOVETAIL JOINT	MPVR94584	● 0006	€ 1,02
PLASTIC COVER Ø 30	MPVR94704	● 0006	€ 0,51
PLASTIC COVER Ø 8	MPVR94431		€ 0,11

SERVICE FOOD TROLLEY

CODE
CARR00087

UNIT PRICE
€ 161,60



TECHNICAL DATA

Trolley dimensions
l x L x h
mm 830 x 410 x 980 h

Weight
7,1 kg

Volume
0,070 m³

EQUIPPED WITH:

- 3 shelves in polypropylene
- Aluminum brackets
- Metal wheels Ø 100 mm

CLEANING TROLLEYS RANGE /

ALL TERRAIN

VILCART

CODE
CARR02481 - IP39

UNIT PRICE
€ 475,20



TECHNICAL DATA

Trolley dimensions
l x L x h
mm 600 x 850 x 1105 h

Weight
10,8 kg

Volume
0,297 m³

DESIGNED FOR:

holiday parks, caravan parks, camping sites and all the places where there are several accommodations over a large area. Perfect when the cleaning staff needs to move the equipment outdoors among the different lodgings over all types of terrain, such as, grass, gravel, concrete, paving stones, etc.

APPLICATION AREA



WELCART

CODE
CARR02480 - IP39

UNIT PRICE
€ 686,40



TECHNICAL DATA

Trolley dimensions
l x L x h
cm 600 x 850 x 1160 h

Weight
14,2 kg

Volume
0,297 m³

DESIGNED FOR:

change linen and clean bungalows, accommodations and rooms in holiday villages, camping sites and wherever the cleaning staff needs to move outside on all types of terrain such as grass, gravel, concrete, paving stones, etc. Thanks to its extraordinary capacity, Welcart allows the operator to carry all cleaning equipment at once, making easier the displacements and reducing the efforts.

APPLICATION AREA



CLEANING TROLLEYS RANGE /

PACKS

IPC – CLASSROOM CLEANING KIT

CODICE
KTRI06259 0005

UNIT PRICE
€ 84,40

IPC has created a kit for the daily cleaning of classrooms.

It's composed by microfiber cloths, microfiber pads, a hand pad holder, a sealed watertight bucket with lid and a 6 l bucket.

Kits can be prepared each day. Simply pour your cleaning and sanitizing solution over the microfiber, seal the lid on the bucket and turn it upside down to pretreat the pads and cloths.

BLUE BUCKET
22 L



BLUE LID



BUCKET 6 L



HAND PAD HOLDER



MICROFIBRE BLUE CLOTH
40X40 (5 PCS)



MICROFIBRE BLUE LOOP
(2 PCS)



MICROFIBRE SPOT
(3 PCS)



COMPOSITION	QUANTITY	CODE	DIGIT
BLUE BUCKET 22 L	1	SECC70027	NNB6
BLUE LID FOR BUCKET 22 L	1	SECC70002	
BUCKET 6 L	1	SECC00056	0508
HAND PAD HOLDER	1	ATPA00078	0015
MICROFIBRE BLUE CLOTH 40X40 CM	5	PANN00118	0005
MICROFIBRE BLUE LOOP HOOK AND LOOP FASTENERS 24 CM	2	FRAN00608	
MICROFIBRE SPOT HOOK AND LOOP FASTENERS 24 CM	3	TESS00290	

GLASS WINDOW PACK

CODE
KTRI04728

UNIT PRICE
€ 80,30

A full pack dedicated to window cleaning. It includes a swivel strip washer and a stainless steel window squeegee, suitable to clean without effort the glass surfaces, eliminating drips and streaks.

The 22 l. bucket on wheels facilitates the transport of the equipment and the telescopic pole permits to reach the highest angles. A pocket scraper and a Vetrix cloth complete the pack.

22 LT. BUCKET WITH WHEELS AND SIEVE FOR STRIP WASHER HEAD



VETRIX CLOTH



SWIVEL STRIP WASHER COMPLETE WITH ABRASIVE 35 CM



INOX WINDOW SQUEEGEE 35 CM



TELESCOPIC POLE 2X0,5 M



"ABC" SAFETY SCRAPER WITH BLADES



COMPOSITION	QUANTITY	CODE	DIGIT
22 LT. BUCKET WITH WHEELS	1	SECC00016	0003
SIEVE FOR STRIP WASHER HEAD	1	STRI70031	
VETRIX CLOTH	1	PANN00012	0004
SWIVEL STRIP WASHER COMPLETE WITH ABRASIVE 35 CM	1	VEC000006	
INOX WINDOW SQUEEGEE 35 CM	1	TERG00010	
TELESCOPIC POLE 2X0,5 M	1	PRTE00008	0003
"ABC" SAFETY SCRAPER WITHOUT BLADE	1	RASC70026	42ST
BOX WITH 100 BLADES "ABC" SAFETY SCRAPER	1	LAMA70015	SST

TRIGGY PACK

CODE
KTRI04725

UNIT PRICE
€ 100,80

Triggy is the one tool solution for floor cleaning, practical and easy use. Assembling the mop on the frame, the equipment is ready to start cleaning. The tool is equipped with a 1 lt. solution tank and an ergonomic handle to facilitate the grab.

The pack includes also an Hygiene microfiber mop, bleaching and aggressive detergent resistant, and a Just Once cloth, that ensures an effective cleaning result in a single step, thus preventing the bacteria proliferation and infections transmission.

TRIGGY



HYGIENE HOOK AND LOOP FASTENERS 40X11 CM



JUST ONCE 40X12 CM



COMPOSITION	QUANTITY	CODE	DIGIT
TRIGGY	1	ATPA00111	0009
HYGIENE HOOK AND LOOP FASTENERS 40X11 CM	5	FRAN00981	
JUST ONCE 40X12 CM	1 PACK (100 pcs)	PANN00065	

UNIKIT

**THE HANDY
SOLUTION**

SINGLE UNIKIT
WITHOUT ACCESSORIES

CODE
CARR02515

UNITS
1

UNIT PRICE
€ 73,90

SIZE
mm 385 x 600 x 965 h



SUGGESTED KITS:

WINDOW CLEANING KIT

CODE
KTRI05329

UNIT PRICE
€ 101,40



NR	COMPOSITION	CODE	DIGIT	QUANTITY
.01	SQUEEGEETECH COMBO 35 CM	TEVE00001	IP09	1
.02	SQUEEGEETECH REPLACEMENT	FRAN01578	IP09	5
.03	350 ML TANK - GREEN	PMVR95823	0009	1
.04	MINI TRAY - GREEN	MPVR94924	0009	2
.05	DRAIN SIEVE	STRI00065	0006	1
.06	WINDOW SCRAPER	RASC00009	IP09	1
.07	BLADES FOR WINDOW SCRAPER	LAMA00006	-	1
.08	FREEPOLE - POLE TWIST LOCK	PRTE00045	0009	1
.09	MICRO GLASS	PANN00047	0015	3
.10	VETRIX CLOTH 38X40 CM	PANN00012	0004	3
.11	RUBBER REPLACEMENT	LGMIO0008	-	5

MANUAL FLOORCARE KIT

CODE
KTRI05330

UNIT PRICE
€ 358,80



NR	COMPOSITION	CODE	DIGIT	QUANTITY
.01	FREEPOLE - POLE TWIST LOCK	PRTE00045	0009	1
.02	ALUVEL	ATPA00183	0009	1
.03	SHARK 40 CM HOOK AND LOOP FASTENERS	FRAN01644	-	25
.04	BELT PREMIUM	PORT00011	-	1
.05	ROUNDED GARBAGE BAG	SACC00062	0002	1

HOTEL SMART KIT

CODE
KTRI05331

UNIT PRICE
€ 399,40



NR	COMPOSITION	CODE	DIGIT	QUANTITY
.01	FREEPOLE - POLE TWIST LOCK	PRTE00045	0009	1
.02	ALUVEL	ATPA00183	0009	1
.03	SHARK 40 CM HOOK AND LOOP FASTENERS	FRAN01644	-	25
.04	BELT PREMIUM	PORT00011	-	1
.05	ROUNDED GARBAGE BAG	SACC00062	0002	1
.06	DISPOSABLE WIPES	PANN00124	IP15	1
.07	350 ML TANK - BLUE	PMVR95823	0015	1
.08	350 ML TANK - RED	PMVR95823	0002	1
.09	MICRO UP - BLUE	PANN00070	0005	3
.10	MICRO UP - RED	PANN00070	0002	3
.11	MINI TRAY - GREEN	MPVR94924	0009	2
.12	MICRO GLASS	PANN00047	0015	3
.13	SPONCOLOR - RED	SPUG00016	0002	1

DOUBLE UNIKIT
WITHOUT ACCESSORIES

CODE
CARR02516

UNITS
1

UNIT PRICE
€ 190,10

SIZE
mm 385 x 635 x 865 h



SUGGESTED KIT:

MANUAL CLEANING KIT

CODE
KTRI05332

UNIT PRICE
€ 402,80



NR	COMPOSITION	CODE	DIGIT	QUANTITY
.01	DISPOSABLE WIPES	PANN00124	IP15	1
.02	FREEPOLE - POLE TWIST LOCK	PRTE00045	0009	1
.03	ALUVEL	ATPA00183	0009	1
.04	SHARK 40 CM HOOK AND LOOP FASTENERS	FRAN01644	-	15
.05	BELT PREMIUM	PORT00011	-	1
.06	ROUNDED GARBAGE BAG	SACC00062	0002	1
.07	TOILETTE PAPER ROLL HOLDER	TESS00380	-	1
.08	SIMPLY/FASTY	PATT00008	0006	1
.09	350 ML TANK - BLUE	PMVR95823	0015	1
.10	350 ML TANK - RED	PMVR95823	0002	1
.11	350 ML TANK - YELLOW	PMVR95823	0004	1
.12	MINI TRAY - GREEN	MPVR94924	0009	4
.13	WINDOW SCRAPER	RASC00009	IP09	1
.14	BLADES FOR WINDOW SCRAPER	LAMA00006	-	1
.15	MICRO GLASS	PANN00047	0015	3
.16	VETRIX CLOTH 38X40 CM	PANN00012	0004	3
.17	MICRO UP - BLUE	PANN00070	0005	5
.18	MICRO UP - RED	PANN00070	0002	5
.19	SPONCOLOR - GREEN	SPUG00016	0003	1
.20	MAGIC NANO SPONGE - GREEN	PANN00055	0003	1

ACCESSORIES

MINI TRAY

CODE
MPVR94924

DIGIT
0009

UNITS
1

UNIT PRICE
€ 2,03



MINI WRINGER

CODE
STRI00065

DIGIT
0006

UNITS
1

UNIT PRICE
€ 2,75



CLEANO SERIES

WINDOW & SURFACES INDOOR CLEANING

Lightweight, handy and easy to use, thanks its aluminum / polypropylene structure and its articulated joints system that allow you to easily reach even the most difficult points.



.01

MICROPADS

5 Micropads for each cleaning need. Remove dust, fingerprints, grease and other dirt. The hook and loop fasteners support allows you to operate without difficult hookings.

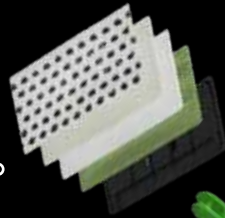

.02

INTERCHANGEABLE FRAMES
3 different frames are available, rectangular or trapezoidal.

.03

TELESCOPIC AND SINGLE HANDLE VERSIONS

You can choose among 8 different versions of Cleano, 4 telescopic and 4 "single handle" up to a maximum length of 6 meters.

.04

SPRAYING SYSTEM

It dispenses the right quantity of solution with each spray (1 cc) granting both cost control and waste reduction.

HIGH CAPACITY TANK, NO-PREFILLED

Tank with a capacity of 200 cc (Cleano 30), 400 cc (Cleano 45 and 100) and 750 cc (Cleano Telescopic).

CHEMICAL PERMITTING

.05

IMMEDIATE CLEANING WITHOUT EFFORT

INNOVATIONS

#01



ERGONOMIC HANDLE SHAPE

EFFORTLESS

The ergonomic shape of the handle grants an easy grip maximizing performances and reducing efforts.

#02



ARTICULATED JOINT

TO REACH THE TRICKIEST POINTS

The innovative robust and completely flexible swivel system enables the user to reach points that are normally difficult to clean, unless using ladders or rolling towers.

#03



FILTER QUICK RELEASE

FILTER CLEANING HAS NEVER BEEN SO FAST

The filter quick release allows a fast and effective cleaning.

#04



DETACHABLE HEAD

YOU CAN DECIDE WHICH FRAME TO USE

Hooking / release mechanism lets you choose the frame to be used for all applications.

CLEANO SERIES

CLEANO 10



CODE	DIGIT	SUPPORT	SIZE	UNIT PRICE
TERI70034	0000E18G32121ST	Rectangular	23	€ 22,35

CLEANO 30



CODE	DIGIT	SUPPORT	SIZE	UNIT PRICE
TERI70036	IZ4GZZ4G22112ST	Rectangular	23	€ 65,50

CLEANO 45



CODE	DIGIT	SUPPORT	SIZE	UNIT PRICE
TERI70033	GG4GZZ5SS2111ST	Rectangular	23	€ 113,80
TERI70047	GG4GZZ5SS2111ST	Trapezoidal	30	€ 115,40
TERI70048	GG4GZZ5SS2111ST	Trapezoidal	40	€ 117,10

CLEANO 100



CODE	DIGIT	SUPPORT	SIZE	UNIT PRICE
TERI70029	GG4GZZ5SS2111ST	Rectangular	23	€ 120,60
TERI70031	GG4GZZ5SS2111ST	Trapezoidal	30	€ 122,30
TERI70046	GG4GZZ5SS2111ST	Trapezoidal	40	€ 123,90

TELESCOPIC CLEANO

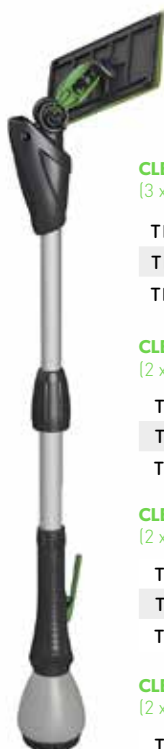

CODE	DIGIT	SUPPORT	SIZE	UNIT PRICE
CLEANO 600 (3 x 200 cm)				
TERI70023	XX4GGG5SS2111ST	Rectangular	23	€ 262,00
TERI70018	XX4GGG5SS2111ST	Trapezoidal	30	€ 263,50
TERI70045	XX4GGG5SS2111ST	Trapezoidal	40	€ 265,10
CLEANO 300 (2 x 150 cm)				
TERI70022	XX4GGG5SS2111ST	Rectangular	23	€ 175,80
TERI70013	XX4GGG5SS2111ST	Trapezoidal	30	€ 177,40
TERI70044	XX4GGG5SS2111ST	Trapezoidal	40	€ 179,10
CLEANO 140 (2 x 70 cm)				
TERI70021	XX4GGG5SS2111ST	Rectangular	23	€ 148,30
TERI70012	XX4GGG5SS2111ST	Trapezoidal	30	€ 149,90
TERI70043	XX4GGG5SS2111ST	Trapezoidal	40	€ 151,50
CLEANO 70 (2 x 35 cm)				
TERI70020	GG4GGG5SS2111ST	Rectangular	23	€ 135,80
TERI70017	GG4GGG5SS2111ST	Trapezoidal	30	€ 137,50
TERI70042	GG4GGG5SS2111ST	Trapezoidal	40	€ 139,20

COMPONENTS:

RECTANGULAR FRAME



CODE	DIGIT	PCS/BOX	SIZE	UNIT PRICE
COPL70200	S ST	1	23	€ 9,30

TRAPEZOIDAL FRAME



CODE	DIGIT	PCS/BOX	SIZE	UNIT PRICE
COPL70199	S ST	1	30	€ 9,90
COPL70204	S ST	1	40	€ 12,80

GLASS MOP

IDEAL FOR

- GLASS
- MIRRORS
- STAINLESS STEEL



APPLICATION AREAS



Ultra-microfiber pad for window cleaning. Combined with an alcohol-based chemical product, it cleans brightly with only one wipe, eliminates dust, fingerprints, grease and other light dirt. Thanks to the wide surface and compared to the traditional pads, Glass Mop covers a bigger area in shorter time with excellent results.

SNOW

IDEAL FOR

- WHITE BOARDS
- MARBLE
- CANTEEN'S TABLE



APPLICATION AREAS



White short pile microfiber with good sliding effect, suitable for wet/dump (washing) and dry (dusting) cleaning. The excellent fluidity ensures effective cleaning results in removing dirt on all types of surface.

SPOT

IDEAL FOR

- BAR COUNTER
- INDUSTRIAL KITCHENS
- WHITE TILES



APPLICATION AREAS



The combination of white short pile microfiber (suitable for any type of surface) and the black abrasive spots (to rub the stubborn stains) ensures an excellent result in removing even the most difficult soil.

ZEBRY

IDEAL FOR

- PVC SURFACES
- PLEXIGLASS
- LAMINATE SURFACES



Zebry has a very special "V" structure that purposely interrupts the uniformity of the contact between the microfibres and the surface itself. The spaces that are created allow the strand to penetrate deeper into the pores of the surfaces or into the grouts of tiles and to carry out a more careful and complete cleaning.

APPLICATION AREAS



SUPER STICKY

IDEAL FOR

- FURNISHING
- DESKS
- DUSTY SHELVES

CODE
PANN00073

DIMENSIONS
9 m

UNITS/BOX
1

UNIT PRICE
€ 13,30



APPLICATION AREAS



Disposable polyester cloth with a special adhesive treatment. Practical, easy to use by hand or with Cleano 10, provides an adhesive power of 99% to capture all types of soil without leaving any residue.

CLEANO PADS	VERSION	CODE	DIGIT	DIMENSIONS	UNITS/BOX	UNIT PRICE
GLASS MOP HOOK AND LOOP FASTENERS	RECTANGULAR	FRAN01001	0003	24	50	€ 4,80
	TRAPEZOIDAL	FRAN00999	0003	30	50	€ 6,00
	TRAPEZOIDAL	FRAN01000	0003	40	50	€ 7,10
SNOW HOOK AND LOOP FASTENERS	RECTANGULAR	TESS00276	-	24	50	€ 4,30
	RECTANGULAR	FRAN00243	-	30	50	€ 4,70
	RECTANGULAR	FRAN00615	0001	40	50	€ 5,60
SPOT HOOK AND LOOP FASTENERS	RECTANGULAR	TESS00290	-	24	50	€ 4,50
	RECTANGULAR	FRAN00242	-	30	50	€ 5,00
	RECTANGULAR	FRAN00862	-	40	50	€ 6,50
ZEBRY HOOK AND LOOP FASTENERS	RECTANGULAR	TESS00316	-	24	50	€ 4,70
	RECTANGULAR	FRAN00244	-	30	50	€ 6,20
	RECTANGULAR	FRAN00946	0001	40	50	€ 7,80

CLEANO 10 DISCOVERY PACK

CODE	DIGIT	SUPPORT	SIZE	UNIT PRICE
TERI70034	0000E18G38121ST	Rectangular	23	€ 52,80

CLEANO 10



GLASS MOP



SNOW



SPOT



ZEBRY



SUPER STICKY



TRIGGER SPRAY



TELESCOPIC POLE



CLEANO 30 DISCOVERY PACK

CODE	DIGIT	SUPPORT	SIZE	UNIT PRICE
TERI70036	IZ4GZZ4G28112ST	Rectangular	23	€ 97,30

CLEANO 30



GLASS MOP



SNOW



SPOT



ZEBRY



SUPER STICKY



CLEANO 45 DISCOVERY PACK

CODE	DIGIT	SUPPORT	SIZE	UNIT PRICE
TERI70033	GG4GZZ5SS8111ST	Rectangular	23	€ 145,60
TERI70047	GG4GZZ5SS8111ST	Trapezoidal	30	€ 153,30
TERI70048	GG4GZZ5SS8111ST	Trapezoidal	40	€ 160,70

CLEANO 45



GLASS MOP



SNOW



SPOT



ZEBRY



SUPER STICKY



CLEANO 100 DISCOVERY PACK

CODE	DIGIT	SUPPORTO	SIZE	UNIT PRICE
TERI70029	GG4GZZ5SS8111ST	Rectangular	23	€ 152,50
TERI70031	GG4GZZ5SS8111ST	Trapezoidal	30	€ 156,60
TERI70046	GG4GZZ5SS8111ST	Trapezoidal	40	€ 160,20

CLEANO 100



GLASS MOP



SNOW



SPOT



ZEBRY



SUPER STICKY



TELESCOPIC CLEANO DISCOVERY PACK

CODE	DIGIT	SUPPORTO	SIZE	UNIT PRICE
CLEANO 600 (3 x 200 cm)				
TERI70023	XX4GGG5SS8111ST	Rectangular	23	€ 293,70
TERI70018	XX4GGG5SS8111ST	Trapezoidal	30	€ 301,40
TERI70045	XX4GGG5SS8111ST	Trapezoidal	40	€ 309,00
CLEANO 300 (2 x 150 cm)				
TERI70022	XX4GGG5SS8111ST	Rectangular	23	€ 207,60
TERI70013	XX4GGG5SS8111ST	Trapezoidal	30	€ 215,40
TERI70044	XX4GGG5SS8111ST	Trapezoidal	40	€ 222,70
CLEANO 140 (2 x 70 cm)				
TERI70021	XX4GGG5SS8111ST	Rectangular	23	€ 180,10
TERI70012	XX4GGG5SS8111ST	Trapezoidal	30	€ 187,80
TERI70043	XX4GGG5SS8111ST	Trapezoidal	40	€ 195,30
CLEANO 70 (2 x 35 cm)				
TERI70020	GG4GGG5SS8111ST	Rectangular	23	€ 167,70
TERI70017	GG4GGG5SS8111ST	Trapezoidal	30	€ 175,40
TERI70042	GG4GGG5SS8111ST	Trapezoidal	40	€ 182,80

CLEANO TELESCOPIC



GLASS MOP



SNOW



SPOT



ZEBRY



SUPER STICKY



PURE WATER SYSTEM

The chemical-free option for window cleaning. It takes a few minutes and you have Pure Water to start cleaning with.



WHAT IS QUICK PURE BOTTLE?

is an easy way to get pure water quickly.



ADVANTAGES

- | | | | | |
|--|--|--|--|---|
| <p>#01</p> <p>EASY</p> <p>You just need to insert the resin bag and shake</p> | <p>#02</p> <p>LONG LASTING</p> <p>Resin bag filters up to 600 l of water (1200 bottles)</p> | <p>#03</p> <p>PRATICAL</p> <p>Portable surfaces and glass cleaning solution</p> | <p>#04</p> <p>EFFECTIVE</p> <p>It reduces the fixed water residue up to 600 TDS ppm</p> | <p>#05</p> <p>CHEMICAL FREE</p> <p>Suitable for cleaning any surface</p> |
|--|--|--|--|---|

HOW TO USE:

01. Remove the Resin Bag from the plastic bag.
02. Place the Resin Bag into the Quick Pure Bottle.
03. Fill-in with tap water up to about 2,5 cm from the upper edge.
04. Shake it up to purify water or let to stand overnight.

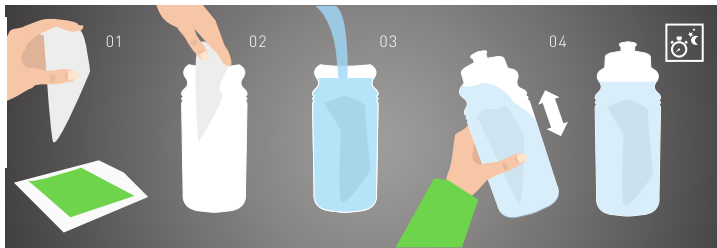

TIPS:



Hard water

If we use **HARD WATER** to clean glasses, on these one, will remain a lot of halos and the glass **WILL NOT BE PERFECTLY TRASPARENT.**



Pure water

On the contrary **PURE WATER**, leaves the glasses **COMPLETELY FREE OF HALOS**, being totally without dissolved minearals.

TECHNICAL DATA - CAPACITY: 650 ml

TDS PPM FIXED WATER RESIDUE	DENSITY (KG/M ³)	QUALITY	SHAKING TIME*	# OF BOTTLES
10-70	0,260	VERY SOFT	< 1 min	1200-170
70-150	0,130	SOFT	1-2 min	170-81
150-250	0,087	SLIGHTLY HARD	2-3 min	81-49
250-320	0,065	MODERATELY HARD	3-4 min	49-38
320-420	0,051	HARD	4-5 min	38-29
420-600	0,043	VERY HARD	5-7 min	29-20

* Reduce shake time in half by adding 2 bags per bottle.

QUICK PURE BOTTLE KIT



CODE	WEIGHT g	DIMENSION (LxWxH) mm	CAPACITY ml	PACK	UNIT PRICE
KTRI05106	160	100 x 100 x 210 h	650	8 kit/box	€ 20,80

QUICK PURE RESING BAG



CODE	WEIGHT g	DIMENSION (LxH) mm	PACK	UNIT PRICE
PMVR06430	113	100 x 200 h	5 pcs	€ 14,55

QUICK PURE BOTTLE ONLY



CODE	WEIGHT g	DIMENSION (Ø x H) mm	CAPACITY ml	PACK	UNIT PRICE
MPVR11730	50	Ø73 x 200 h	650	-	€ 6,30

TDS METER



CODE	WEIGHT g	DIMENSION (LxWxH) mm	PACK	UNIT PRICE
AZMC40006	54	142 x25 x15 h	1 pcs	€ 76,70

DESCRIPTION

The ultimate device for testing the purity of liquids. Portable and easy to use, it comes with its case provided with clip. Always ready to use! It is just necessary to remove the protective cap and to immerse the probes in the liquid to be measured. The automatic temperature compensation makes life even much easier: it allows accurate interpretations of the data. The removal of the tool from the water is possible thanks to the hold function, checking the data is of course easier. Ideal for many domestic or applications. With a range of 0-9990 ppm, the J.B.W. TDS is perfect for a wide range of tasks. It is a convenient way to test the water in swimming pools, aquariums, taps reverse osmosis filters or other sources, to know if water you drink or use is suitable for your use.

1. Measurement Range: 0-9990 ppm
2. Accuracy: ± 2%
3. Batteries: 2 x 1.5 V LR44 battery charger
4. Auto-off function: 10 minutes
5. Operating Temperature: 0-99°C / 32-212°F
6. ATC (Automatic Temperature Compensation): 0-50°C / 122°F



BELT

- **IMPROVES OPERATOR'S COMFORT**

Thanks to its basic structure allows the transpiration and reduces moisture and sweat on the back while is worn.

- **PROTECTS THE WELL-BEING OF THE OPERATOR**

This type of belt distributes the weight on the sides of the operator rather than on the shoulders, significantly reducing the effort.

- **OPTIMIZES THE TIME**

Refine working time and improves productivity.

- **EASY TO USE**

A practical solution that optimizes the productivity of the window washing kit.

APPLICATIONS

Ideal for the cleaning of the areas where it is not possible to use the traditional cleaning kit:

- STATIONS
(train stations, metro,...)
- STAIRS
- CONFINED SPACES



STANDARD KIT

CODE
PORT00010

Suitable also for
TRIGGY & TRIGGY DETACHABLE

UNIT PRICE
€ 103,30

COMPOSITION	UNITS	CODE	DIGIT	UNIT PRICE
BELT	1	PORT00009		€ 34,50
SINGLE BLUE POCKET	1	TESS00375	0005	€ 26,60
SINGLE RED POCKET	1	TESS00376	0002	€ 23,35
BOTTLE HOLDER	1	TESS00379		€ 19,00

PREMIUM KIT

CODE
PORT00011

Ideal to be used with
CLEANO, TRIGGY & TRIGGY DETACHABLE

UNIT PRICE
€ 130,10

COMPOSITION	UNITS	CODE	DIGIT	UNIT PRICE
BELT	1	PORT00009		€ 34,50
DOUBLE BLUE POCKET	1	TESS00374	0005	€ 30,05
DOUBLE RED POCKET	1	TESS00377	0002	€ 27,70
BOTTLE HOLDER	2	TESS00379		€ 19,00

BELT



BLUE POCKET



RED POCKET



BOTTLE HOLDER



OPTIONALS

ROUNDED GARBAGE BAG

CODE
SACC00062-0002
UNIT PRICE
€ 34,50



TOILETTE PAPER ROLL HOLDER

CODE
TESS00380
UNIT PRICE
€ 27,70



* Contains max 3 rolls

TRIGGER SPRAY

CODE
PMVR95667
● 0005 ● 0002
● 0009 ● 0004

CAPACITY
500 ml

UNITS
10

UNIT PRICE
€ 2,15



WINDOW CLEANING

IPC standard window cleaning range includes a complete solution of basic equipment (from washers, to squeegee, till poles) for an effective and complete cleaning of glass and reflective surfaces.

UNIHANDLE

THE ONLY ANSWER



MULTIFUNCTIONAL

The innovative Pulex **UNIHANDLE** (patent-pending) is an ergonomic handle, completely versatile and made with high quality materials. Matched with three different accessories, this handle is the answer to each window cleaning need.

1. COMBI VERSION

Equipped with IPC double-face microfiber pad, this model allows even the most grimy windows to be washed and remove stubborn dirt.

2. SQUEEGEE VERSION

Matched with high quality natural Pulex rubber, it wipes perfectly without leaving marks or halos.

3. SCRAPER VERSION

This version, combined with scraper, easily removes even the most stubborn or encrusted dirt.

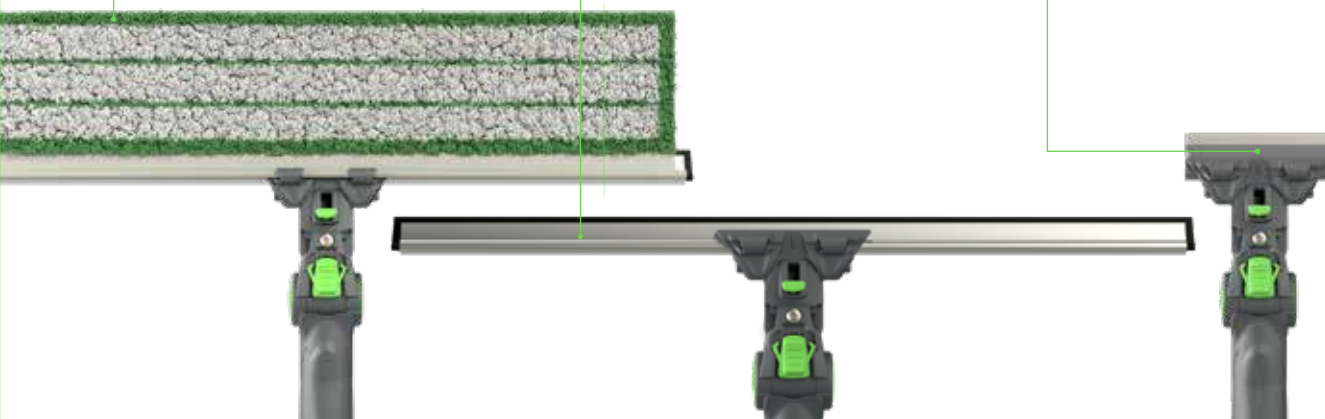

A ONE-PASS TOOL TO WASH AND WIPE AT THE SAME TIME, OPTIMIZING THE NORMALLY REQUIRED TIMES.

VERSATILE

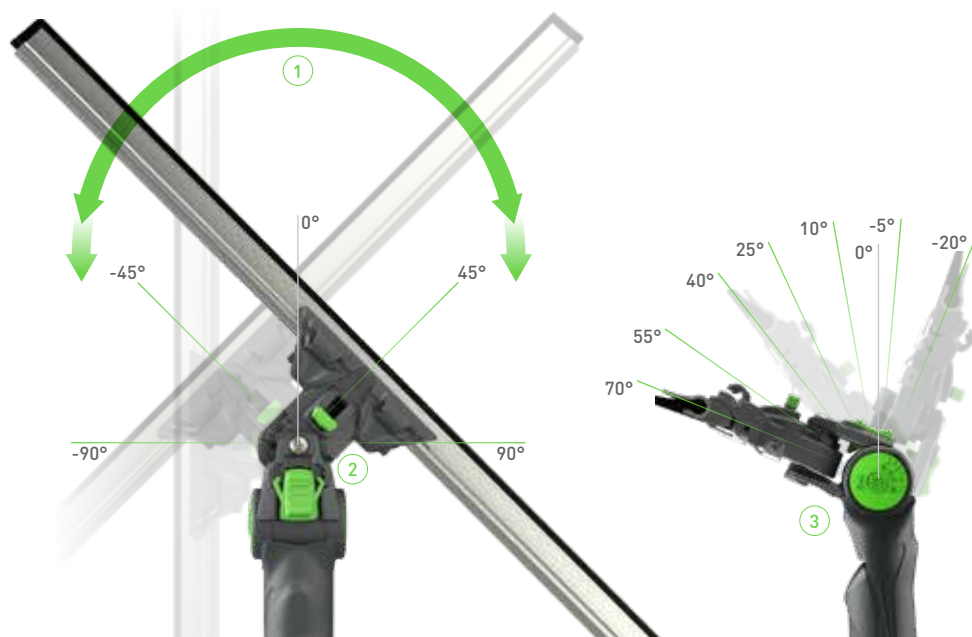

1. EXCLUSIVE PIVOTING SYSTEM

Fluid movement of rotation, free (up to $\pm 180^\circ$) or limited (up to $\pm 150^\circ$), which guarantees speed and efficiency.

2. ROTATION LOCKING

It is possible to stop the rotation movement in 5 different angular positions (0° , $\pm 45^\circ$, $\pm 90^\circ$).

3. EXTRA-WIDE ADAPTABLE ANGLE

It allows the tool to be adjusted according to cleaning needs or your preferences (-20° , -5° , 10° , 25° , 40° , 55° , 70°).

UNIHANDLE



Available in 3 kit with 3 different sizes:

KIT 25 cm, KIT 35 cm, KIT 45 cm.

Each kit is composed by:

handle + clips + striped aluminium support + hard rubber + sleeve microtiger

CODE	DIGIT	SIZE	WEIGHT g	PACK	UNIT PRICE
TERG80200	IPIA	KIT 25 cm	226	1	€ 48,00
TERG80201	IPIA	KIT 35 cm	257	1	€ 51,60
TERG80202	IPIA	KIT 45 cm	287	1	€ 55,20

UNIHANDLE - COMPONENTS & ACCESSORIES

HANDLE



CODE	DIGIT	WEIGHT g	PACK	UNIT PRICE
IMPU80200	IPIA	140	10	€ 27,60

REPLACEMENT SLEEVE MICROTIGER



CODE	SIZE	WEIGHT g	PACK	UNIT PRICE
VELL80228	8 X 25 cm	35	10	€ 14,40
VELL80229	8 X 35 cm	45	10	€ 16,80
VELL80230	8 X 45 cm	60	10	€ 19,20

CLIP



CODE	DIGIT	WEIGHT g	PACK	UNIT PRICE
CLIP80006 (SX)	0009	7	25	€ 1,20
CLIP80005 (DX)	0009	7	25	€ 1,20

STAINLESS STEEL CHANNEL FOR LONG HANDLE WITH RUBBER



CODE	SIZE	WEIGHT g	PACK	UNIT PRICE
SUPP80158	25 cm / 10 inch	66	25 pcs	€ 3,75
SUPP80160	35 cm / 14 inch	96	25 pcs	€ 4,55
SUPP80161	45 cm / 18 inch	124	25 pcs	€ 5,40

LINED ALUMINUM CHANNEL WITH HARD RUBBER



CODE	SIZE	WEIGHT g	PACK	UNIT PRICE
SUPP80303	25 cm / 10 inch	45	25 pcs	€ 3,05
SUPP80305	35 cm / 14 inch	65	25 pcs	€ 4,20
SUPP80307	45 cm / 18 inch	80	25 pcs	€ 5,00

SCRAPER ONLY



CODE	SIZE	WEIGHT g	PACK	UNIT PRICE
RASC70017	102 x 23 x 10 mm	36	100	€ 2,14

WINDOW CLEANING /

PULEX RANGE

BELT FOR TUBEX



CODE	WEIGHT	UNITS	UNIT PRICE
CINT80009	130 g	10	€ 9,00

CLIP FOR TUBEX



CODE	WEIGHT	UNITS	UNIT PRICE
CINT80010	57 g	10	€ 3,35

TUBEX HOLSTER



CODE	WEIGHT	UNITS	UNIT PRICE
PORT80001	298 g	10	€ 15,30

TUBEX HOLSTER DETACHABLE



CODE	WEIGHT	UNITS	UNIT PRICE
PORT80002	340 g	10	€ 18,40

TECHNOLITE T-BAR WINDOW WASHER



CODE	CM	WEIGHT	UNITS	UNIT PRICE
VEC080235	25	122 g	50	€ 7,10
VEC080236	35	145 g	50	€ 7,30
VEC080237	45	168 g	50	€ 7,55

TECHNOLITE - MICROTIGER COMPLETE



CODE	CM	WEIGHT	UNITS	UNIT PRICE
VEC080242	25	167 g	100	€ 13,30
VEC080243	35	200 g	100	€ 14,50
VEC080244	45	251 g	50	€ 15,70

TECHNOLITE WINDOW SQUEEGEE COMPLETE



CODE	CM	WEIGHT	UNITS	UNIT PRICE
TERG80154	25	168 g	10	€ 12,40
TERG80156	35	198 g	10	€ 13,20
TERG80158	45	227 g	10	€ 14,00

TECHNOLITE WINDOW SQUEEGEE HANDLE



CODE	WEIGHT	UNITS	UNIT PRICE
IMPU80078	100 g	10	€ 8,30

TELESCOPIC POLES / PULEX RANGE

TELESCOPIC POLES



CODE	VERSION	UNIT PRICE
PRTE80154	4 x 1,5 m	€ 81,70
PRTE80155	4 x 2 m	€ 102,00
PRTE80156	4 x 2,5 m	€ 122,70
PRTE80157	4 x 3 m	€ 144,40

TELESCOPIC POLES - ACCESSORIES / PULEX RANGE

MULTIPURPOSE CLAMP FOR POLE



CODE	WEIGHT	UNITS	UNIT PRICE
RACC70033	29 g	10	€ 18,40

SPONGE FOR CLAMP



CODE	WEIGHT	UNITS	UNIT PRICE
SPUG70004	40 g	50	€ 1,83

TECHNO SCRAP FLOOR & WINDOW SCRAPER



CODE	DIMENSION	WEIGHT	UNITS	UNIT PRICE
RASC80042	205 x 110 x 35 mm	145 g	25	€ 11,50

NIPPER MULTI-PURPOSE REACHER



CODE	DIMENSION	WEIGHT	UNITS	UNIT PRICE
ATRA00002	70	390 g	10	€ 24,60
ATRA00003	100	420 g	10	€ 27,60
ATRA80020	200	632 g	10	€ 42,60

MUSTIK COLORED FLOOR SQUEEGEE - WITH WHITE FOAM RUBBER

CODE	DIGIT	DIMENSION	UNITS	WEIGHT	UNIT PRICE
ATPA80084	● 0003	35 cm	30	233 g	€ 8,15
	● 0002				
	● 0005				
	● 0004				
ATPA80085	● 0003	45 cm	30	283 g	€ 8,75
	● 0002				
	● 0005				
	● 0004				
ATPA80086	● 0003	55 cm	30	330 g	€ 10,40
	● 0002				
	● 0005				
	● 0004				
ATPA80087	● 0003	65 cm	30	367 g	€ 11,10
	● 0002				
	● 0005				
	● 0004				
ATPA80088	● 0003	75 cm	30	404 g	€ 11,90
	● 0002				
	● 0005				
	● 0004				

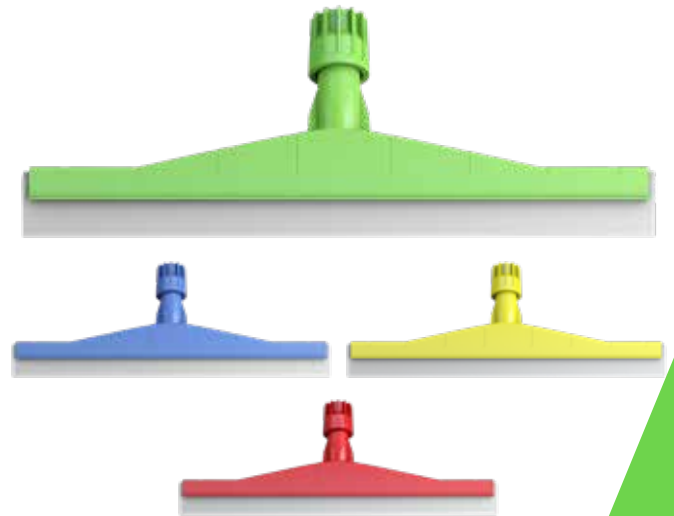

BRASS WINDOW SQUEEGEE FIXED "ETTORE"



CODE	DIM.	UNITS	UNIT PRICE
TERG00001	cm 25	10	€ 19,70
TERG00002	cm 30	10	€ 20,80
TERG00003	cm 35	10	€ 21,90
TERG00004	cm 40	10	€ 22,60
TERG00005	cm 45	10	€ 23,90
TERG00006	cm 50	10	€ 24,40
TERG00007	cm 55	10	€ 25,70

BRASS SUPPORTS "ETTORE" WITH RUBBER



CODE	DIM.	UNITS	UNIT PRICE
SUPP00001	cm 25	12	€ 9,60
SUPP00002	cm 30	12	€ 10,70
SUPP00003	cm 35	12	€ 12,20
SUPP00004	cm 40	12	€ 13,10
SUPP00005	cm 45	12	€ 13,60
SUPP00006	cm 50	12	€ 14,30
SUPP00007	cm 55	12	€ 15,80

RUBBER "ETTORE"

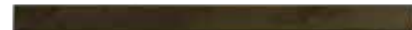

CODE	DIM.	UNITS	UNIT PRICE
LGM100001	cm 25	12	€ 3,40
LGM100004	cm 35	12	€ 3,70
LGM100006	cm 40	12	€ 3,90
LGM100005	cm 45	12	€ 4,10
LGM100002	cm 92	12	€ 7,60

QUICK RELEASE BRASS HANDLE "ETTORE"



CODE	UNITS	UNIT PRICE
IMPU00001	12	€ 16,00

SWIVEL HANDLE "ETTORE"



CODE	UNITS	UNIT PRICE
IMPU00002	12	€ 19,20

FIXED BRASS HANDLE "ETTORE"



CODE	UNITS	UNIT PRICE
IMPU00003	12	€ 10,20

TERMINAL CONE



CODE	UNITS	UNIT PRICE
RACC00003	1	€ 7,50

NEW

INOX STAINLESS STEEL WINDOW SQUEEGEE



CODE	CM	UNITS	UNIT PRICE
TERG00008	25	10	€ 9,35
TERG00009	30	10	€ 9,75
TERG00010	35	10	€ 10,20
TERG00011	40	10	€ 10,70
TERG00012	45	10	€ 11,00
TERG00013	50	10	€ 11,50
TERG00014	55	10	€ 12,00

INOX HANDLE



CODE	UNITS	UNIT PRICE
IMPU00004	10	€ 6,00

INOX CHANNEL WITH RUBBER



CODE	CM	UNITS	UNIT PRICE
SUPP00008	25	25	€ 3,60
SUPP00009	30	25	€ 4,00
SUPP00010	35	25	€ 4,30
SUPP00011	40	25	€ 4,90
SUPP00012	45	25	€ 5,20
SUPP00013	50	25	€ 5,60
SUPP00014	55	25	€ 6,10

BRASS WINDOW SQUEEGEE COMPLETE WITH SOFT RUBBER BLADE



CODE	DIGIT	CM	UNITS	UNIT PRICE
TERG70044	NOX3 S30ST	25	10	€ 11,70
TERG70045	NOX3 S30ST	30	10	€ 12,20
TERG70046	NOX3 S30ST	35	10	€ 12,80
TERG70047	NOX3 S30ST	40	10	€ 13,60
TERG70048	NOX3 S30ST	45	10	€ 14,11
TERG70049	NOX3 S30ST	50	10	€ 14,72
TERG70050	NOX3 S30ST	55	10	€ 15,13

BRASS WINDOW SQUEEGEE HANDLE



CODE
IMPU70051

DIGIT
NOX 30ST

UNITS
10

UNIT PRICE
€ 6,70

CLIP FOR BRASS



CODE
CLIP70003

DIGIT
S ST

UNITS
100

UNIT PRICE
€ 0,11

BRASS CHANNEL WITH SOFT RUBBER BLADE AND CLIPS



CODE	DIGIT	CM	UNITS	UNIT PRICE
SUPP70165	3 M25ST	25	25	€ 4,98
SUPP70166	3 M25ST	30	25	€ 5,60
SUPP70167	3 M25ST	35	25	€ 6,20
SUPP70168	3 M25ST	40	25	€ 6,80
SUPP70169	3 M25ST	45	25	€ 7,31
SUPP70170	3 M25ST	50	25	€ 8,12
SUPP70171	3 M25ST	55	25	€ 8,53

SWIVEL SQUEEGEE HANDLE



CODE	DIGIT	UNITS	UNIT PRICE
IMPU70053	NON 30ST	10	€ 6,80

Suitable only with brass channels

SQUEEGEETECH

SWIVEL WINDOW SQUEEGEE COMPLETE WITH BLACK RUBBER



CODE	DIGIT	CM	UNITS	UNIT PRICE
TERG00035	IP09	35	10	€ 10,60

PLASTIC SQUEEGEE
BLACK IS BLACK



CODE	DIGIT	CM	UNITS	UNIT PRICE
TERG70023	ST62 S23ST	20	10	€ 3,65
TERG70024	ST62 S23ST	25	10	€ 3,97
TERG70025	ST62 S23ST	30	10	€ 4,27
TERG70026	ST62 S23ST	35	10	€ 4,47
TERG70027	ST62 S23ST	40	10	€ 4,77
TERG70028	ST62 S23ST	45	10	€ 5,08

PLASTIC HANDLE
BLACK IS BLACK



CODE	DIGIT	UNITS	UNIT PRICE
IMPU70046	ST6 23ST	10	€ 1,52

ALUMINUM CHANNEL
WITH RUBBER



CODE	DIGIT	CM	UNITS	UNIT PRICE
SUPP70143	2 M25ST	20	25	€ 1,93
SUPP70144	2 M25ST	25	25	€ 2,24
SUPP70145	2 M25ST	30	25	€ 2,64
SUPP70146	2 M25ST	35	25	€ 2,95
SUPP70147	2 M25ST	40	25	€ 3,25
SUPP70148	2 M25ST	45	25	€ 3,55

RUBBER REPLACEMENT



CODE	CM	UNITS	UNIT PRICE
LGM100007	25	100	€ 1,63
LGM100011	30	100	€ 1,73
LGM100008	35	100	€ 1,93
LGM100012	40	100	€ 2,15
LGM100009	45	100	€ 2,35
LGM100013	50	50	€ 2,85
LGM100010	55	100	€ 3,15
LGM100003	92	100	€ 4,30

SWIVEL STRIP WASHER COMPLETE



CODE	CM	UNITS	TYPE	UNIT PRICE
VEC000001	25	10	STANDARD	€ 8,95
VEC000002	35	10	STANDARD	€ 10,90
VEC000003	45	10	STANDARD	€ 12,30
VEC000004	55	10	STANDARD	€ 14,45

SWIVEL STRIP WASHER COMPLETE WITH ABRASIVE



CODE	CM	UNITS	TYPE	UNIT PRICE
VEC000005	25	10	ABRASIVE	€ 9,95
VEC000006	35	10	ABRASIVE	€ 12,10
VEC000007	45	10	ABRASIVE	€ 14,35

FIXED STRIP WASHER COMPLETE



CODE	CM	UNITS	TYPE	UNIT PRICE
VEC000008	25	10	STANDARD	€ 7,55
VEC000009	35	10	STANDARD	€ 9,45
VEC000010	45	10	STANDARD	€ 10,60

FIXED STRIP WASHER COMPLETE WITH ABRASIVE



CODE	CM	UNITS	TYPE	UNIT PRICE
VEC000019	25	10	ABRASIVE	€ 8,65
VEC000020	35	10	ABRASIVE	€ 10,70
VEC000021	45	10	ABRASIVE	€ 12,50

FIXED SUPPORT FOR STRIP WASHER



CODE	DIGIT	CM	UNITS	UNIT PRICE
VEC000016	● 0003	25	10	€ 3,35
VEC000017	● 0003	35	10	€ 3,80
VEC000018	● 0003	45	10	€ 4,10

SWIVEL SUPPORT FOR STRIP WASHER



CODE	DIGIT	CM	UNITS	UNIT PRICE
VEC000012	● 0003	25	10	€ 4,70
VEC000013	● 0003	35	10	€ 5,20
VEC000014	● 0003	45	10	€ 5,80
VEC000015	● 0003	55	10	€ 7,55

FIXED SUPPORT FOR STRIP WASHER
BLACK IS GREEN™



CODE	DIGIT	CM	UNITS	UNIT PRICE
VEC070159	NOK 05ST	35	50	€ 2,45
VEC070160	NOK 05ST	45	50	€ 2,75

DEEP SNOW REPLACEMENT SLEEVE



CODE	CM	UNITS	UNIT PRICE
VELL00033	25	10	€ 5,20
VELL00034	35	10	€ 6,00
VELL00035	45	10	€ 6,70
VELL00036	55	10	€ 8,12

MICROTIGER STRIP WASHER



CODE	DIGIT	CM	UNITS	UNIT PRICE
VELL70107	NO 7 08ST	25	10	€ 5,40
VELL70108	NO 7 08ST	35	10	€ 6,30
VELL70109	NO 7 08ST	45	10	€ 7,31

STRIP WASHER TWISTED REPLACEMENT



CODE	CM	UNITS	TYPE	UNIT PRICE
VELL00001	25	10	STANDARD	€ 4,30
VELL00002	35	10	STANDARD	€ 5,70
VELL00003	45	10	STANDARD	€ 6,50
VELL00004	55	10	STANDARD	€ 6,80

STRIP WASHER TWISTED REPLACEMENT WITH ABRASIVE



CODE	CM	UNITS	TYPE	UNIT PRICE
VELL00008	25	10	ABRASIVE	€ 5,30
VELL00009	35	10	ABRASIVE	€ 6,90
VELL00010	45	10	ABRASIVE	€ 8,55

STRIP WASHER TWISTED REPLACEMENT



CODE	CM	UNITS	TYPE	UNIT PRICE
VELL00014	25	10	STANDARD	€ 5,10
VELL00016	35	10	STANDARD	€ 5,80
VELL00017	45	10	STANDARD	€ 6,50
VELL00018	55	10	STANDARD	€ 7,00

STRIP WASHER TWISTED REPLACEMENT WITH ABRASIVE



CODE	CM	UNITS	TYPE	UNIT PRICE
VELL00019	25	10	ABRASIVE	€ 6,00
VELL00020	35	10	ABRASIVE	€ 7,35
VELL00021	45	10	ABRASIVE	€ 8,15

MICROFIBRE STRIP WASHER REPLACEMENT



CODE	CM	UNITS	UNIT PRICE
VELL00005	25	10	€ 5,10
VELL00006	35	10	€ 6,70
VELL00007	45	10	€ 8,25

SQUEEGEETECH COMBO

SWIVEL WINDOW SQUEEGEE WITH BLACK RUBBER & MICROFIBER PAD



CODE	DIGIT	CM	UNITS/BOX	UNIT PRICE
TEVE00001	IP09	35	10	€ 17,90

SQUEEGEETECH MICROFIBER REPLACEMENT



CODE	DIGIT	CM	UNITS/BOX	UNIT PRICE
FRAN01578	IP09	35	1	€ 5,30

TECHNODUO



CODE	DIGIT	CM	UNITS/BOX	UNIT PRICE
TEVE70076	N08IEI111EU21ST	25	10	€ 19,90
TEVE70077	N08IEI111EU21ST	35	10	€ 22,05
TEVE70078	N08IEI111EU21ST	45	5	€ 24,50

22 LT. BUCKET
WITH 4 WHEELS Ø 50MM

CODE SECC00016 ● 0005 ● 0002 ● 0003

DIMENSION mm300x560x320 h

SIZE Kg 1,47

VOLUME 0,152 m³



UNIT PRICE € 18,30

STAINLESS STEEL DRAIN SIEVE
FOR 22 LT. BUCKET

CODE STRI70002 - S ST

UNITS/BOX 10

UNIT PRICE € 12,70



PLASTIC DRAIN SIEVE
FOR 22 LT. BUCKET

CODE STRI70031

UNITS/BOX 10

UNIT PRICE € 8,95



350 ML TANK

CODE PMVR95823

● 0015 ● 0002
● 0009 ● 0004

CAPACITY 350 ml

UNITS/BOX 1

UNIT PRICE € 1,83



TRIGGER SPRAY

CODE PMVR95667

● 0005 ● 0002
● 0009 ● 0004

CAPACITY 500 ml

UNITS/BOX 10

UNIT PRICE € 2,15



TELESCOPIC POLE



CODE	DIGIT	SIZE	UNITS	UNIT PRICE
PRTE00022	●0003	1,00 m	20	€ 7,25
PRTE00001	●0003	1,25 m	20	€ 8,25
PRTE00002	●0003	1,50 m	20	€ 9,05
PRTE00008	●0003	2x0,50 m	20	€ 8,85
PRTE00007	●0003	2x1,00 m	10	€ 15,75
PRTE00004	●0003	2x1,25 m	10	€ 17,50
PRTE00005	●0003	2x1,50 m	10	€ 19,80
PRTE00006	●0003	2x1,75 m	10	€ 22,95
PRTE00010	●0003	2x2,00 m	10	€ 24,30
PRTE00011	●0003	2x2,50 m	10	€ 29,15
PRTE00013	●0003	3x0,65 m	10	€ 20,40
PRTE00014	●0003	3x0,80 m	10	€ 23,65
PRTE00015	●0003	3x1,00 m	10	€ 26,90
PRTE00016	●0003	3x1,25 m	10	€ 29,15
PRTE00017	●0003	3x1,50 m	10	€ 30,80
PRTE00018	●0003	3x2,00 m	10	€ 37,90
PRTE00012	●0003	2x3,00 m	10	€ 31,40
PRTE00019	●0003	3x3,00 m	10	€ 48,90
PRTE00020	●0003	4+4+3 m	10	€ 76,90

FREEPOLE

POLE LOCK WITH QUICK CONNECT END CONE



CODE	DIGIT	SIZE	SIZE	UNITS	UNIT PRICE
PRTE00045	0009	3 X 0,40 m	Ø 25 cm	1	€ 14,85

SCREW-RING FOR POLE



CODE	DIGIT	SIZE	UNITS	UNIT PRICE
MPVR94687	●0003	Ø 25 cm	1	€ 1,43
MPVR94688	●0003	Ø 30 cm	1	€ 1,53

JAW FOR POLE



CODE	DIGIT	SIZE	UNITS	UNIT PRICE
MPVR94685	●0003	Ø 25 cm	1	€ 2,85
MPVR94686	●0003	Ø 30 cm	1	€ 3,05

PLASTIC CONE FOR TELESCOPIC POLE



CODE	DIGIT	VERSION	UNITS	UNIT PRICE
RACC00001	●0003	STANDARD	10	€ 3,35

CRANKED JOINT FOR TELESCOPIC POLE

CODE RACC00002 - 0003

UNITS/BOX 10

UNIT PRICE € 8,70



HANDLE HOLDER BAR



CODE	DIGIT	UNITS	UNIT PRICE
MPVR94925	IP06	1	€ 19,10

FLOOR SCRAPER

CODE
RASC00009 - IP09

UNITS
1 pc

UNIT PRICE
€ 3,05



BLADE FOR FLOOR SCRAPER

CODE
LAMA00006

UNITS
1 BOX with 10 blades

UNIT PRICE
€ 2,85



"ABC" SAFETY SCRAPER

CODE
RASC70026 - 42ST

DIMENSION
4 cm

UNITS
10 pcs

UNIT PRICE
€ 4,20



"ABC" SCRAPER WITH 5 BLADES

CODE
RASC70025 - 02ST

DIMENSION
4 cm

UNITS
10 pcs

UNIT PRICE
€ 5,70



BOX WITH 5 BLADES

CODE
LAMA70014 - S ST

DIMENSION
4 cm

UNITS
1 BOX with 5 blades

UNIT PRICE
€ 1,43



BOX WITH 100 BLADES

CODE
LAMA70015 - S ST

DIMENSION
4 cm

UNITS
1 BOX with 100 blades

UNIT PRICE
€ 17,20



SCRAPER WITH 10 BLADES WITH PLASTIC CASE

CODE
RASC70016 -31ST

DIMENSION (L x W x H)
100 x 22 x 0,2 mm

WEIGHT
73 g

UNITS
25 pz

UNIT PRICE
€ 5,90



SCRAPER BLADE HOLDER

CODE
RASC70017 - 07ST

DIMENSION (L x W x H)
102 x 23 x 10 mm

WEIGHT
36 g

UNITS
100 pz

UNIT PRICE
€ 2,14



BLADE FOR SCRAPER

CODE
RASC70018 - 42ST

DIMENSION (L x W x H)
100 x 14 x 0,5 mm

WEIGHT
3,5 g

UNITS
100 pz

UNIT PRICE
€ 0,31



FLOOR SCRAPER



CODE	CM	UNITS	VERSION	UNIT PRICE
RASC00002		10	WINDOWS	€ 9,95
RASC00003	25	10	FLOORS & WINDOWS	€ 10,80
RASC00004	120	10	FLOORS & WINDOWS	€ 15,95

BLADE FOR FLOOR SCRAPER

CODE
LAMA00003

BOX
10 pz

UNITS
20 box

UNIT PRICE
€ 0,75



WALL & PIPE DUSTER LOOP SHAPE

CODE
SCOV00006

UNITS
10

UNIT PRICE
€ 5,00



WALL DUSTER

CODE
SCOV00005

UNITS
10

UNIT PRICE
€ 5,70



WALL DUSTER WITH EXTENSIBLE HANDLE

CODE
SCOV00012

UNITS
12

UNIT PRICE
€ 4,30



WINDOW CLEANING KIT

CODE
COMB00009

UNITS
10

UNIT PRICE
€ 169,10



COMPOSITION	CODE	DIGIT
WINDOW CLEANING BAG ONLY	COMB00010	
INOX HANDLE	IMPU00004	
INOX CHANNEL WITH RUBBER 25 CM	SUPP00008	
INOX CHANNEL WITH RUBBER 35 CM	SUPP00010	
INOX CHANNEL WITH RUBBER 45 CM	SUPP00012	
RUBBER REPLACEMENT 92 CM	LGMI00003	
PLASTIC T-HANDLE 25 CM	VECO00016	• 0015
PLASTIC T-HANDLE 35 CM	VECO00017	• 0015
STANDARD SLEEVE 35 CM WITH BLUE RIBBON	VELL00016	
STANDARD SLEEVE ABRASIVE 35 CM WITH BLUE RIBBON	VELL00019	
TELESCOPIC POLE 3X0,65 CM	PRTE00013	• 0005
CRANKED JOINT FOR TELESCOPIC POLE	RACC00002	• 0005
COBWEB AND DUST COLLECTOR	SCOV00005	
SPONGE FOR CLAMP	SPUG70004	
VETRIX CLOTH 38X40 CM	PANN00012	• 0004
SCRAPER WITH 10 BLADES IN PLASTIC CASE	RASC70016	05 ST

SCUBATECH NEOPRENE GLOVES

CODE
FRAN01532
FRAN01533
FRAN01534
FRAN01535

SIZE
S (7)
M (8)
L (9)
XL (10)

UNITS
1

UNIT PRICE
€ 26,90



TOUCH

The special fingers touch tips allow the use of smartphones and tablets



PROTECTION

Technical material to protect the hands. It ensures a full protection in all working phases



SLIP RESISTANT

Non-slip material to ensure a safe grip to the tools, handles, etc.



ADJUSTABLE

Equipped with a comfortable and adjustable strap with hook and loop fasteners

DISPENSERS

IPC provides dispensers for paper and soap with a large variety of models.

SUPPORT VULCANO



CODE
CART00037

UNIT PRICE
€ 152,00

MATERIAL
Stainless Steel

PESO
13,80 KG

DIMENSIONS
LxLxh
mm 485 x 423 x 1405

UNIT BOX
1



SUPPORT LIPARI



CODE
CART00036

UNIT PRICE
€ 92,00

MATERIAL
Stainless Steel

PESO
6,60 KG

DIMENSIONS
LxLxh
mm 290 x 290 x 1620

UNIT BOX
1



SUPPORT PIANOSA



CODE
CART00038

UNIT PRICE
€ 102,00

MATERIAL
Polypropylene

PESO
1,30 KG

DIMENSIONS
LxLxh
mm 430 x 520

UNIT BOX
1



* dispenser not included

LEVITA MINI MANUAL

CODE
ACBA00006

DIGIT
○ AM01

UNIT PRICE
€ 19,00

CAPACITY
350 ml

MATERIAL
ABS

DIMENSIONS
l x L x h
mm 108 x 82 x 160 h

DETAILS
· With Key Lock

UNIT BOX
10



LEVITA MANUAL

CODE
ACBA00005

DIGIT
○ AM01

UNIT PRICE
€ 21,50

CAPACITY
900 ml

MATERIAL
ABS

DIMENSIONS
l x L x h
mm 132 x 85 x 210 h

DETAILS
· With Key Lock

UNIT BOX
10



LEVITA NO-TOUCH



CODICE
ACBA00252

UNIT PRICE
€ 100,00

MATERIAL
ABS

DIMENSIONS
l x L x h
mm 125x132x260 h

UNIT BOX
1



LEVITA MINI INOX PLUS

CODE
ACBA00056

UNIT PRICE
€ 43,85

CAPACITY
1000 ml

MATERIAL
Stainless Steel

DIMENSIONS
l x L x h
mm 130x105x205 h

UNIT BOX
20

CODE
ACBA00057

UNIT PRICE
€ 40,80

CAPACITY
500 ml

MATERIAL
Stainless Steel

DIMENSIONS
l x L x h
mm 100x105x155 h

UNIT BOX
30



LEVITA INOX PLUS

CODE
ACBA00024

UNIT PRICE
€ 126,90

CAPACITY
1000 ml

MATERIAL
Stainless Steel

DIMENSIONS
l x L x h
mm 115x100x260 h

DETAILS
· With Key Lock

UNIT BOX
1



AMALFI

CAPACITY
600 Towels
L max 250 mm

MATERIAL
ABS

DIMENSIONS
l x L x h
mm 285 x 135 x 370 h

DETAILS
· Key Lock
· Towels fold to C or Z or V

UNIT BOX
4

CODE
ACBA00010

DIGIT
○ 0001

UNIT PRICE
€ 23,65



CODE
ACBA00010

DIGIT
● 0075

UNIT PRICE
€ 24,90



CAPRI

CAPACITY
Roll
Ø max 135 mm
L 225 mm

MATERIAL
ABS

DIMENSIONS
l x L x h
mm 255 x 170 x 210 h

DETAILS
· Key Lock
· Towels fold to C or Z or V

UNIT BOX
2

CODE
ACBA00007

DIGIT
○ 0001

UNIT PRICE
€ 21,55



CODE
ACBA00007

DIGIT
● 0075

UNIT PRICE
€ 22,55



AUTOCUT

CODE
ACBA00008

CAPACITY
Roll
Ø max 195 mm
L min 195 mm
L max 205 mm

MATERIAL
ABS

DIMENSIONS
l x L x h
mm 315 x 205 x 330 h

UNIT BOX
1

UNIT PRICE
€ 105,50



CANTÙ

CAPACITY
Roll
Ø max 300 mm
L 100 mm

MATERIAL
ABS

DIMENSIONS
(mm)
310 X 130 X 330 h

DETAILS
- With Key Lock
- Internal hole adapter, Ø 70 mm / 42 mm

UNIT BOX
2

CODE
ACBA00013

DIGIT
○ 0001

UNIT PRICE
€ 25,70



CODE
ACBA00013

DIGIT
● 0075

UNIT PRICE
€ 26,40



POSITANO

CAPACITY
2 Rolls
Ø max 125
L 115 mm

MATERIAL
ABS

DIMENSIONS
l x L x h
mm 285 x 150 x 145 h

DETAILS
- With key lock
- Paper roll Ø max 125 mm - L max 115 mm
- Interleaved sheets (fold to Z or V) - L max 115 mm

UNIT BOX
4

CODE
ACBA00009

DIGIT
○ 0001

UNIT PRICE
€ 20,50



CODE
ACBA00009

DIGIT
● 0075

UNIT PRICE
€ 21,55



AMALFITANO

CAPACITY
600 toilet paper sheets
110x120 mm

MATERIAL
ABS

DIMENSIONS
l x L x h
mm 140 x 135 x 280 h

DETAILS
- With key lock
- Toilet paper sheets fold to C or Z or V

UNIT BOX
4

CODE
ACBA00012

DIGIT
○ 0001

UNIT PRICE
€ 18,30



CODE
ACBA00012

DIGIT
● 0075

UNIT PRICE
€ 19,10



SORRENTO MINI

CAPACITY
Roll
Ø max 130

MATERIAL
ABS

DIMENSIONS
l x L x h
mm 140 x 140 x 287 h

DETAILS
· With Key Lock

UNIT BOX
4

CODE
ACBA00044

UNIT PRICE
€ 25,60



CODE
ACBA00045

UNIT PRICE
€ 27,40



SORRENTO

CAPACITY
Roll
Ø max 220 mm

MATERIAL
ABS

DIMENSIONS
l x L x h
mm 230 x 235 x 340 h

DETAILS
· With Key Lock

UNIT BOX
1

CODE
ACBA00014

DIGIT
○ 0001

UNIT PRICE
€ 36,95



CODE
ACBA00014

DIGIT
● 0076

UNIT PRICE
€ 38,00



CANTU INOX PLUS

CODE
ACBA00027

UNIT PRICE
€ 98,50

CAPACITY
Roll
Ø max 295 L 130 mm

MATERIAL
Stainless Steel

DIMENSIONS
l x L x h
mm 300x135x300 h

DETAILS
· With Key Lock

UNIT BOX
1

CODE
ACBA00028

UNIT PRICE
€ 88,30

CAPACITY
Roll
Ø max 215 L 110 mm

MATERIAL
Stainless Steel

DIMENSIONS
l x L x h
mm 220x120x220 h

DETAILS
· With Key Lock

UNIT BOX
1



AMALFI INOX PLUS

CODE
ACBA00025

UNIT PRICE
€ 92,30

CAPACITY
600 Towels
L max 245 x 105 mm
H max 320 mm

MATERIAL
Stainless Steel

DIMENSIONS
l x L x h
mm 250x115x325 h

DETAILS
· With Key Lock
· Towels fold to C or Z or V

UNIT BOX
1



AMALFITANO INOX PLUS

CODE
ACBA00026

UNIT PRICE
€ 89,00

CAPACITY
600 Towels
Max 110x120 mm

MATERIAL
Stainless Steel

DIMENSIONS
l x L x h
mm 140x120x280 h

DETAILS
· With Key Lock
· Towels fold to C or Z or V

UNIT BOX
1



SECURITY

CODE
POCA00007

DIGIT
 0001

UNIT PRICE
€ 50,05

CAPACITY
Roll
Ø max 290 mm
L max 290 mm

MATERIAL
ABS

DIMENSIONS
l x L x h
mm 410 x 345 x 350 h

UNIT BOX
1



CAPRI COMBI ROLL

CODE
POCA00005

DIGIT
 0001

UNIT PRICE
€ 18,30

CAPACITY
Roll
Ø max 165 mm
L max 245 mm

MATERIAL
ABS

DIMENSIONS
l x L x h
mm 294 x 210 x 170 h

UNIT BOX
1



WALL

CODE
POCA00002

UNIT PRICE
€ 34,70

CAPACITY
Roll
Ø max 320 mm
L max 300 mm

MATERIAL
Metal

DIMENSIONS
l x L x h
mm 400 x 330 x 280 h

UNIT BOX
10



ONSHORE

CODE
POCA00003

UNIT PRICE
€ 48,40

CAPACITY
Roll
Ø max 320 mm
L max 380 mm

MATERIAL
Metal

DIMENSIONS
l x L x h
mm 485 x 400 x 765 h

UNIT BOX
10



CORTESE

CODE
ACBA00046

UNIT PRICE
€ 10,50

CAPACITY
100 Napkins

MATERIAL
ABS

DIMENSIONS
L x L x h
mm 268x134x75 h

UNIT BOX
30



IGEN WC

CODE
ACBA00004

DIGIT
○ 0001

UNIT PRICE
€ 18,00

CAPACITY
200 cover wc

MATERIAL
ABS

DIMENSIONS
L x L x h
mm 220x55x285 h

UNIT BOX
6



IGEN BAGS INOX

CODE
ACBA00023

UNIT PRICE
€ 39,50

CAPACITY
Bags dimensions max
128x270 mm

MATERIAL
Stainless Steel

DIMENSIONS
L x L x h
mm 130x45x270 h

UNIT BOX
1



RAFFAELLO TERRA

CODE
CONT00007UNIT PRICE
€ 89,00MATERIAL
Stainless SteelDIMENSIONS
L x L x h
mm 240x240x390 hDETAILS
· Hanging on floorUNIT BOX
1

TERRA INOX PLUS

CODE
ACBA00002UNIT PRICE
€ 49,30MATERIAL
Stainless SteelDIMENSIONS
ø x h
Ø 100x350 hDetails
· Hanging on floorUNIT BOX
1

GIRONET

CODE
ACBA00001UNIT PRICE
€ 10,80MATERIAL
PolypropyleneDIMENSIONS
L x L x h
mm 112x120x390 hDETAILS
· Hanging on wall/ floorUNIT BOX
12

FRAGRANCE DIFFUSER

CODE
ACBA00125UNIT PRICE
€ 69,00DIMENSIONS
L x L x h
mm 75x85x210 hUNIT BOX
1

FRAGRANCES REFILLS

UNIT PRICE
€ 14,25

DESCRIPTION	CODE	CAPACITY	BOX
ODOR ABSORBER	ACBA00096	250 ml	6 pz
FRAGRANCE "BREEZE"	ACBA00101	250 ml	6 pz
FRAGRANCE "SECRET"	ACBA00081	250 ml	6 pz
FRAGRANCE "VANILLA"	ACBA00083	250 ml	6 pz
FRAGRANCE "COOL RIVER"	ACBA00080	250 ml	6 pz
FRAGRANCE "RELAX"	ACBA00094	250 ml	6 pz
FRAGRANCE "FRESH COTTON"	ACBA00109	250 ml	6 pz
FRAGRANCE "LAVANDER"	ACBA00108	250 ml	6 pz

TEXTILE FRAGRANCES

UNIT PRICE
€ 24,40

DESCRIPTION	CODE	CAPACITY	BOX
FRAGRANCE "BREEZE"	ACBA00186	500 ml	20 pz
FRAGRANCE "LAVANDA"	ACBA00187	500 ml	20 pz
FRAGRANCE "FRESH COTTON"	ACBA00190	500 ml	20 pz
FRAGRANCE "BLUE VELVET"	ACBA00188	500 ml	20 pz
FRAGRANCE "SOFT"	ACBA00189	500 ml	20 pz

MAN

CODE
CART00004

MATERIAL
Stainless Steel

DIMENSIONS
L x h

mm 80x80 h

UNIT BOX
1

UNIT PRICE
€ 20,20



WOMAN

CODE
CART00005

MATERIAL
Stainless Steel

DIMENSIONS
L x h

mm 80x80 h

UNIT BOX
1

UNIT PRICE
€ 20,20



DONNA/UOMO

CODE
CART00006

MATERIAL
Stainless Steel

DIMENSIONS
L x h

mm 80x80 h

UNIT BOX
1

UNIT PRICE
€ 20,20



WOMAN/MAN/HANDICAP

CODE
CART00007

MATERIAL
Stainless Steel

DIMENSIONS
L x h

mm 80x80 h

UNIT BOX
1

UNIT PRICE
€ 20,20



NO SMOKING

CODE
CART00008

MATERIAL
Stainless Steel

DIMENSIONS
L x h

mm 80x80 h

UNIT BOX
1

UNIT PRICE
€ 20,20



DRYERS

A wide range of hair dryers
and hair hand dryers

ARIAL

POWER
2300 W

MATERIAL
Stainless Steel

DIMENSIONS
l x L x h
mm 261 x 210 x 236 h

UNIT BOX
1

CODE
ACBA00029

UNIT PRICE
€ 340,30

COLOR
POLISHED
WITH PHOTO CELL



CODE
ACBA00030

UNIT PRICE
€ 329,60

COLOR
POLISHED
WITH PUSH BOTTON



CODE
ACBA00015

UNIT PRICE
€ 308,10

COLOR
**LACQUERED
WHITE**
WITH PHOTO CELL



CODE
ACBA00016

UNIT PRICE
€ 297,20

COLOR
**LACQUERED
WHITE**
WITH PUSH BOTTON



VENTOS

CODE
ACBA00031

UNIT PRICE
€ 170,20

COLOR
POLISHED
WITH PHOTO CELL

POWER
1650 W

MATERIAL
Stainless Steel

DIMENSIONS
l x L x h
mm 220x150x284 h

UNIT BOX
6



CODE
ACBA00017

UNIT PRICE
€ 109,80

COLOR
WHITE
WITH PHOTO CELL

POWER
1650 W

MATERIAL
ABS

DIMENSIONS
l x L x h
mm 220x150x284 h

UNIT BOX
6



DRYERS / HAIR DRYERS

CAPRICCIO WITH WALL HOLDER

CODE
ACBA00018

UNIT PRICE
€ 48,90

COLOR
WHITE

POWER
1200 W

MATERIAL
ABS

DIMENSIONS
l x L x h
mm 90x150x220 h

UNIT BOX
5



MURALE WITH WALL HOLDER

CODE
ACBA00042

UNIT PRICE
€ 109,80

COLOR
WHITE

POWER
800 W

MATERIAL
ABS

DIMENSIONS
l x L x h
mm 180x130x550 h

UNIT BOX
6



CODE INDEX

CODE	DIGIT	UNIT PRICE	PAGE	CODE	DIGIT	UNIT PRICE	PAGE	CODE	DIGIT	UNIT PRICE	PAGE
ACBA00001		€ 10,80	251	ATPA00014	IP15	€ 33,90	34	ATPA00098	0206	€ 8,55	64
ACBA00002		€ 49,30	251	ATPA00014	0002	€ 33,90	34	ATPA00099	1506	€ 9,65	64
ACBA00004	0001	€ 18,00	250	ATPA00014	IP09	€ 33,90	34	ATPA00099	0206	€ 9,65	64
ACBA00005	AM01	€ 21,50	244	ATPA00014	0004	€ 33,90	34	ATPA00100	1506	€ 12,10	64
ACBA00006	AM01	€ 19,00	244	ATPA00016	IP09	€ 3,95	21	ATPA00100	0206	€ 12,10	64
ACBA00007	0001	€ 21,55	245	ATPA00017	IP09	€ 4,65	21	ATPA00101	1506	€ 7,65	64
ACBA00007	0075	€ 22,55	245	ATPA00018	IP09	€ 5,30	21	ATPA00101	0206	€ 7,65	64
ACBA00008		€ 105,50	245	ATPA00019	IP09	€ 6,80	21	ATPA00111	0015	€ 54,90	61
ACBA00009	0001	€ 20,50	246	ATPA00020		€ 7,25	64	ATPA00111	0002	€ 54,90	61
ACBA00009	0075	€ 21,55	246	ATPA00021		€ 8,75	64	ATPA00111	0009	€ 54,90	61
ACBA00010	0001	€ 23,65	245	ATPA00022		€ 12,10	64	ATPA00111	0004	€ 54,90	61
ACBA00010	0075	€ 24,90	245	ATPA00023	9999	€ 6,00	64	ATPA00125	0015	€ 13,60	32
ACBA00012	0001	€ 18,30	246	ATPA00023	1515	€ 6,40	64	ATPA00125	0002	€ 13,60	32
ACBA00012	0075	€ 19,10	246	ATPA00024	9999	€ 6,80	64	ATPA00125	0009	€ 13,60	32
ACBA00013	0001	€ 25,70	246	ATPA00024	1515	€ 7,15	64	ATPA00125	0004	€ 13,60	32
ACBA00013	0075	€ 26,40	246	ATPA00025	9999	€ 9,25	64	ATPA00146	1315	€ 24,00	33
ACBA00014	0001	€ 36,95	247	ATPA00025	1515	€ 9,55	64	ATPA00146	1302	€ 24,00	33
ACBA00014	0076	€ 38,00	247	ATPA00026	1515	€ 5,60	64	ATPA00146	IP09	€ 24,00	33
ACBA00015		€ 308,10	254	ATPA00033	0015	€ 39,50	31	ATPA00146	1304	€ 24,00	33
ACBA00016		€ 297,20	254	ATPA00033	0002	€ 39,50	31	ATPA00147	0015	€ 65,70	61
ACBA00017		€ 109,80	255	ATPA00033	0009	€ 39,50	31	ATPA00147	0002	€ 65,70	61
ACBA00018		€ 48,90	255	ATPA00033	0004	€ 39,50	31	ATPA00147	0009	€ 65,70	61
ACBA00023		€ 39,50	250	ATPA00034	0015	€ 17,40	31	ATPA00147	0004	€ 65,70	61
ACBA00024		€ 126,90	244	ATPA00034	0002	€ 17,40	31	ATPA00178	IP06	€ 17,60	64
ACBA00025		€ 92,30	248	ATPA00034	0009	€ 17,40	31	ATPA00214	0027	€ 28,50	35
ACBA00026		€ 89,00	248	ATPA00034	0004	€ 17,40	31	ATPA00216	15		35
ACBA00027		€ 98,50	248	ATPA00037	0015	€ 24,20	31	ATPA00216	9		35
ACBA00028		€ 88,30	248	ATPA00037	0002	€ 24,20	31	ATPA02008	0009	€ 8,65	21
ACBA00029		€ 340,30	254	ATPA00037	0009	€ 24,20	31	ATPA02009	0009	€ 9,55	21
ACBA00030		€ 329,60	254	ATPA00037	0004	€ 24,20	31	ATPA02010	0009	€ 10,60	21
ACBA00031		€ 107,20	255	ATPA00038	0015	€ 31,30	31	ATPA02011	0009	€ 12,00	21
ACBA00042		€ 109,80	255	ATPA00038	0002	€ 31,30	31	ATPA02012	IP09	€ 31,80	34
ACBA00044		€ 25,60	247	ATPA00038	0009	€ 31,30	31	ATPA02012	IP15	€ 31,80	34
ACBA00045		€ 27,40	247	ATPA00038	0004	€ 31,30	31	ATPA02014	IP09	€ 33,90	34
ACBA00046		€ 10,50	250	ATPA00039	0206	€ 14,75	64	ATPA02014	IP15	€ 33,90	34
ACBA00050		€ 18,80	91	ATPA00040	0206	€ 16,15	64	ATPA02016	IP09	€ 3,95	21
ACBA00051		€ 25,40	91	ATPA00041	0206	€ 19,80	64	ATPA02017	IP09	€ 4,65	21
ACBA00052		€ 42,85	91	ATPA00043	0101	€ 11,40	64	ATPA02018	IP09	€ 5,30	21
ACBA00056		€ 43,85	244	ATPA00044	0101	€ 12,80	64	ATPA02019	IP09	€ 6,80	21
ACBA00057		€ 40,80	244	ATPA00045	0101	€ 16,05	64	ATPA02033	0009	€ 39,50	31
ACBA00080		€ 14,25	251	ATPA00055	1506	€ 26,30	34	ATPA02033	0015	€ 39,50	31
ACBA00081		€ 14,25	251	ATPA00063	0506	€ 13,10	34	ATPA02034	0009	€ 17,40	31
ACBA00083		€ 14,25	251	ATPA00063	0206	€ 13,10	34	ATPA02034	0015	€ 17,40	31
ACBA00094		€ 14,25	251	ATPA00063	0906	€ 13,10	34	ATPA02037	0009	€ 24,20	31
ACBA00096		€ 14,25	251	ATPA00063	0406	€ 13,10	34	ATPA02037	0015	€ 24,20	31
ACBA00101		€ 14,25	251	ATPA00064	1506	€ 15,75	34	ATPA02038	0009	€ 31,30	31
ACBA00108		€ 14,25	251	ATPA00064	0206	€ 15,75	34	ATPA02038	0015	€ 31,30	31
ACBA00109		€ 14,25	251	ATPA00064	0906	€ 15,75	34	ATPA02055	0009	€ 26,30	34
ACBA00125		€ 69,00	251	ATPA00064	0406	€ 15,75	34	ATPA02059	0009	€ 6,30	34
ACBA00186		€ 24,40	251	ATPA00066	0615	€ 16,45	33	ATPA02063	0009	€ 13,10	34
ACBA00187		€ 24,40	251	ATPA00066	0602	€ 16,45	33	ATPA02064	0009	€ 15,75	34
ACBA00188		€ 24,40	251	ATPA00066	IP09	€ 16,45	33	ATPA02066	IP09	€ 16,45	33
ACBA00189		€ 24,40	251	ATPA00066	0604	€ 16,45	33	ATPA02066	IP15	€ 16,45	33
ACBA00190		€ 24,40	251	ATPA00069	1506	€ 24,20	34	ATPA02069	0009	€ 24,20	34
ACBA00252		€ 100,00	244	ATPA00073	0015	€ 30,80	27	ATPA02073	IP09	€ 30,80	27
ATPA00005		€ 28,95	21	ATPA00074	0005	€ 17,00	27	ATPA02074	0009	€ 17,00	27
ATPA00006		€ 31,50	21	ATPA00076	IP15	€ 14,35	65	ATPA02080	0009	€ 15,15	32
ATPA00007		€ 34,00	21	ATPA00078	IP15	€ 15,35	65	ATPA02084	0009	€ 16,05	32
ATPA00008		€ 8,65	21	ATPA00080	0015	€ 15,15	32	ATPA02089	0009	€ 12,50	32
ATPA00009		€ 9,55	21	ATPA00084	0015	€ 16,05	32	ATPA02090	0009	€ 11,70	32
ATPA00010		€ 10,60	21	ATPA00089	0015	€ 12,50	32	ATPA02092	IP09	€ 53,30	27
ATPA00011		€ 12,00	21	ATPA00090	0015	€ 11,70	32	ATPA02096	IP09	€ 35,30	26
ATPA00012	IP15	€ 31,80	34	ATPA00092	0015	€ 53,30	27	ATPA02097	IP09	€ 57,15	26
ATPA00012	0002	€ 31,80	34	ATPA00096	0009	€ 35,30	26	ATPA02146	IP09	€ 24,00	33
ATPA00012	IP09	€ 31,80	34	ATPA00097	0009	€ 57,15	26	ATPA02146	IP15	€ 24,00	33
ATPA00012	0004	€ 31,80	34	ATPA00098	1506	€ 8,55	64	ATPA02215	0009	€ 19,20	27

CODE INDEX

CODE	DIGIT	UNIT PRICE	PAGE	CODE	DIGIT	UNIT PRICE	PAGE	CODE	DIGIT	UNIT PRICE	PAGE
ATPA80084	0003	€ 8,15	231	CARR00424	IP09	€ 110,90	111	CARR00567	IP08827AST	624,70€	150
ATPA80084	0004	€ 8,15	231	CARR00424	IP04	€ 110,90	111	CARR00567	IP08827SST	597,80€	150
ATPA80084	0005	€ 8,15	231	CARR00425	IP15	€ 126,30	110	CARR00567	IP08949AST	531,10€	150
ATPA80084	0002	€ 8,15	231	CARR00425	IP10	€ 126,30	110	CARR00567	IP08949SST	504,10€	150
ATPA80085	0003	€ 8,75	231	CARR00425	IP09	€ 126,30	110	CARR00570	IP08027AST	€ 761,50	154
ATPA80085	0004	€ 8,75	231	CARR00425	IP04	€ 126,30	110	CARR00570	IP08027SST	€ 734,60	154
ATPA80085	0005	€ 8,75	231	CARR00426	IP15	€ 126,30	110	CARR00570	IP08015AST	€ 631,20	154
ATPA80085	0002	€ 8,75	231	CARR00426	IP10	€ 126,30	110	CARR00570	IP08015SST	€ 604,20	154
ATPA80086	0003	€ 10,40	231	CARR00426	IP09	€ 126,30	110	CARR00571	IP08038AST	€ 656,00	152
ATPA80086	0004	€ 10,40	231	CARR00426	IP04	€ 126,30	110	CARR00571	IP08038SST	€ 629,10	152
ATPA80086	0005	€ 10,40	231	CARR00427	IP15	€ 162,60	113	CARR00571	IP08039AST	€ 562,20	152
ATPA80086	0002	€ 10,40	231	CARR00427	IP10	€ 162,60	113	CARR00571	IP08039SST	€ 535,20	152
ATPA80087	0003	€ 11,10	231	CARR00427	IP09	€ 162,60	113	CARR00637	IP06	€ 317,70	168
ATPA80087	0004	€ 11,10	231	CARR00427	IP04	€ 162,60	113	CARR00657	IP06	€ 222,90	169
ATPA80087	0005	€ 11,10	231	CARR00428	IP15	€ 162,60	113	CARR00666	IP06	€ 281,10	170
ATPA80087	0002	€ 11,10	231	CARR00428	IP10	€ 162,60	113	CARR00685	IP06	€ 444,90	175
ATPA80088	0003	€ 11,90	231	CARR00428	IP09	€ 162,60	113	CARR00864	0606	€ 105,60	85
ATPA80088	0004	€ 11,90	231	CARR00428	IP04	€ 162,60	113	CARR00929	0606	€ 103,40	85
ATPA80088	0005	€ 11,90	231	CARR00429	IP15	€ 173,50	114	CARR00966		€ 137,40	83
ATPA80088	0002	€ 11,90	231	CARR00429	IP10	€ 173,50	114	CARR00971		€ 274,70	83
ATRA00002		€ 24,60	231	CARR00429	IP09	€ 173,50	114	CARR00973		€ 412,10	83
ATRA00003		€ 27,60	231	CARR00429	IP04	€ 173,50	114	CARR00974		€ 549,30	83
ATRA80020		€ 42,60	231	CARR00430	IP15	€ 127,50	110	CARR00984	0015	€ 51,30	98
AZMC40006		€ 76,70	223	CARR00430	IP10	€ 127,50	110	CARR00984	0002	€ 51,30	98
AZPR00496		€ 8,25	187	CARR00430	IP09	€ 127,50	110	CARR00984	0009	€ 51,30	98
CARR00006		€ 149,70	101	CARR00430	IP04	€ 127,50	110	CARR00984	0004	€ 51,30	98
CARR00013		€ 213,30	103	CARR00430	IP99	€ 104,40	120	CARR01095		€ 115,30	87
CARR00015		€ 149,70	101	CARR00434	IP15	€ 127,50	110	CARR01096		€ 101,30	87
CARR00016		€ 213,30	103	CARR00434	IP10	€ 127,50	110	CARR01098		€ 86,50	87
CARR00020		€ 161,60	103	CARR00434	IP09	€ 127,50	110	CARR01279	IP99647AST	€ 538,00	130
CARR00021		€ 129,20	102	CARR00434	IP04	€ 127,50	110	CARR01279	IP99647SST	€ 515,60	130
CARR00023		€ 161,60	103	CARR00434	IP99	€ 104,40	120	CARR01279	IP99829AST	553,10€	130
CARR00024		€ 129,20	102	CARR00449	IP06	€ 591,30	179	CARR01279	IP99829SST	530,70€	130
CARR00036		€ 215,50	106	CARR00449	IP15	€ 591,30	179	CARR01287		€ 204,70	121
CARR00038		€ 301,60	105	CARR00497	1515	€ 105,60	85	CARR01293		€ 570,80	149
CARR00041		€ 361,30	105	CARR00497	0101	€ 105,60	85	CARR01307	IP15	€ 106,20	98
CARR00045		€ 312,30	105	CARR00498	1515	€ 103,40	85	CARR01307	IP02	€ 106,20	98
CARR00048		€ 269,30	106	CARR00498	0101	€ 103,40	85	CARR01307	IP09	€ 106,20	98
CARR00050		€ 167,00	89	CARR00506	IP15	€ 121,40	108	CARR01307	IP04	€ 106,20	98
CARR00052		€ 339,30	104	CARR00506	IP10	€ 121,40	108	CARR01353		€ 154,30	101
CARR00056		€ 441,60	104	CARR00506	IP09	€ 121,40	108	CARR01725		€ 146,50	101
CARR00058		€ 484,80	104	CARR00506	IP04	€ 121,40	108	CARR01772	IP15	€ 144,90	112
CARR00087		€ 161,60	203	CARR00507	IP15	€ 121,40	108	CARR01772	IP10	€ 144,90	112
CARR00088		€ 131,70	176	CARR00507	IP10	€ 121,40	108	CARR01772	IP09	€ 144,90	112
CARR00121	IP06	€ 349,00	178	CARR00507	IP09	€ 121,40	108	CARR01772	IP04	€ 144,90	112
CARR00121	IP15	€ 349,00	178	CARR00507	IP04	€ 121,40	108	CARR01773	IP15	€ 144,90	112
CARR00234	IP99	€ 108,80	120	CARR00508	IP15	€ 125,30	107	CARR01773	IP10	€ 144,90	112
CARR00239	IP99	€ 108,80	120	CARR00508	IP10	€ 125,30	107	CARR01773	IP09	€ 144,90	112
CARR00373	0006	€ 238,00	203	CARR00508	IP09	€ 125,30	107	CARR01773	IP04	€ 144,90	112
CARR00378	IP06	€ 444,90	177	CARR00508	IP04	€ 125,30	107	CARR01774	IP15	€ 137,90	109
CARR00378	IP15	€ 444,90	177	CARR00509	IP15	€ 125,30	107	CARR01774	IP10	€ 137,90	109
CARR00390	IP06	€ 336,10	167	CARR00509	IP10	€ 125,30	107	CARR01774	IP09	€ 137,90	109
CARR00392	IP06	€ 271,30	171	CARR00509	IP09	€ 125,30	107	CARR01774	IP04	€ 137,90	109
CARR00396	0006	€ 182,40	166	CARR00509	IP04	€ 125,30	107	CARR01776	IP15	€ 158,30	111
CARR00400	IP06	€ 247,80	172	CARR00510	IP15	€ 126,30	107	CARR01776	IP10	€ 158,30	111
CARR00400	IP23	€ 247,80	172	CARR00510	IP10	€ 126,30	107	CARR01776	IP09	€ 158,30	111
CARR00405	IP06	€ 175,80	173	CARR00510	IP09	€ 126,30	107	CARR01776	IP04	€ 158,30	111
CARR00405	IP23	€ 175,80	173	CARR00510	IP04	€ 126,30	107	CARR01797		€ 387,70	126
CARR00408	IP06	€ 297,70	174	CARR00511	IP15	€ 126,30	107	CARR01802		€ 146,50	101
CARR00408	IP23	€ 297,70	174	CARR00511	IP10	€ 126,30	107	CARR01816		€ 133,20	102
CARR00423	IP15	€ 110,90	111	CARR00511	IP09	€ 126,30	107	CARR01817		€ 133,20	102
CARR00423	IP10	€ 110,90	111	CARR00511	IP04	€ 126,30	107	CARR01847		€ 538,60	127
CARR00423	IP09	€ 110,90	111	CARR00567	IP08646AST	€ 609,60	150	CARR01849		€ 495,50	127
CARR00423	IP04	€ 110,90	111	CARR00567	IP08646SST	€ 582,70	150	CARR01860	IP99457AST	€ 581,60	131
CARR00424	IP15	€ 110,90	111	CARR00567	IP08648AST	€ 516,00	150	CARR01860	IP99457SST	€ 554,70	131
CARR00424	IP10	€ 110,90	111	CARR00567	IP08648SST	€ 489,00	150	CARR01907		€ 175,60	121

CODE INDEX

CODE	DIGIT	UNIT PRICE	PAGE	CODE	DIGIT	UNIT PRICE	PAGE	CODE	DIGIT	UNIT PRICE	PAGE
CARR01930	IP15	€ 137,90	109	CARR50424	IP04	€ 126,00	111	CARR51773	IP09	€ 160,00	112
CARR01930	IP10	€ 137,90	109	CARR50425	IP15	€ 141,40	110	CARR51773	IP04	€ 160,00	112
CARR01930	IP09	€ 137,90	109	CARR50425	IP10	€ 141,40	110	CARR51774	IP15	€ 153,00	109
CARR01930	IP04	€ 137,90	109	CARR50425	IP09	€ 141,40	110	CARR51774	IP10	€ 153,00	109
CARR01953		€ 537,50	148	CARR50425	IP04	€ 141,40	110	CARR51774	IP09	€ 153,00	109
CARR02049	IPGX	€ 115,70	119	CARR50426	IP15	€ 141,40	110	CARR51774	IP04	€ 153,00	109
CARR02049	IPBX	€ 115,70	119	CARR50426	IP10	€ 141,40	110	CARR51776	IP15	€ 173,40	111
CARR02049	IPRX	€ 115,70	119	CARR50426	IP09	€ 141,40	110	CARR51776	IP10	€ 173,40	111
CARR02049	IPIX	€ 115,70	119	CARR50426	IP04	€ 141,40	110	CARR51776	IP09	€ 173,40	111
CARR02049	IPYX	€ 115,70	119	CARR50427	IP15	€ 177,70	113	CARR51776	IP04	€ 173,40	111
CARR02050	IPGX	€ 86,80	119	CARR50427	IP10	€ 177,70	113	CARR51847		€ 553,70	127
CARR02050	IPBX	€ 86,80	119	CARR50427	IP09	€ 177,70	113	CARR51907		€ 190,70	121
CARR02050	IPRX	€ 86,80	119	CARR50427	IP04	€ 177,70	113	CARR51930	IP15	€ 153,00	109
CARR02050	IPIX	€ 86,80	119	CARR50428	IP15	€ 177,70	113	CARR51930	IP10	€ 153,00	109
CARR02050	IPYX	€ 86,80	119	CARR50428	IP10	€ 177,70	113	CARR51930	IP09	€ 153,00	109
CARR02177		€ 154,30	101	CARR50428	IP09	€ 177,70	113	CARR51930	IP04	€ 153,00	109
CARR02323		€ 533,20	127	CARR50428	IP04	€ 177,70	113	CARR52574	0099	€ 331,90	167
CARR02410	IP99	€ 527,00	128	CARR50429	IP15	€ 188,60	114	CARR52688	IP99	€ 685,20	129
CARR02480	IP39	€ 686,40	205	CARR50429	IP10	€ 188,60	114	CARR53016	IP99	€ 284,10	123
CARR02481	IP39	€ 475,20	205	CARR50429	IP09	€ 188,60	114	CARR53039	IP99	€ 125,00	122
CARR02515		€ 73,90	210	CARR50429	IP04	€ 188,60	114	CARR53040	IP99	€ 125,00	122
CARR02516		€ 190,10	212	CARR50430	IP15	€ 142,60	110	CART00004		€ 20,20	252
CARR02574	0099	€ 316,80	167	CARR50430	IP10	€ 142,60	110	CART00005		€ 20,20	252
CARR02688	IP99	€ 670,10	129	CARR50430	IP09	€ 142,60	110	CART00006		€ 20,20	252
CARR02829	0099	€ 914,70	202	CARR50430	IP04	€ 142,60	110	CART00007		€ 20,20	252
CARR02831	0099	€ 707,50	201	CARR50430	IP99	€ 119,95	120	CART00008		€ 20,20	252
CARR02832	0099	€ 1.030,40	202	CARR50434	IP15	€ 142,60	110	CART00011		€ 16,45	198
CARR02958	IP99	€ 161,00	125	CARR50434	IP10	€ 142,60	110	CART00012		€ 16,45	198
CARR02993	0099	€ 862,60	202	CARR50434	IP09	€ 142,60	110	CART00013		€ 16,45	198
CARR02994	0099	€ 764,50	202	CARR50434	IP04	€ 142,60	110	CART00014		€ 16,45	198
CARR02995	0099	€ 610,80	201	CARR50434	IP99	€ 119,95	120	CART00015		€ 16,45	198
CARR03016	IP99	€ 269,00	123	CARR50449	IP06	€ 606,40	179	CART00016		€ 16,45	198
CARR03017	IP99	€ 262,90	123	CARR50506	IP15	€ 136,50	108	CART00017		€ 16,45	198
CARR03018	IP99	€ 212,10	123	CARR50506	IP10	€ 136,50	108	CART00018		€ 16,45	198
CARR03080	IP99	€ 161,00	125	CARR50506	IP09	€ 136,50	108	CART00019		€ 16,45	198
CARR03081	IP99	€ 172,00	125	CARR50506	IP04	€ 136,50	108	CART00020		€ 16,45	198
CARR03090	IP99	€ 543,40	130	CARR50507	IP15	€ 136,50	108	CART00021		€ 16,45	198
CARR03091	IP99	€ 587,00	131	CARR50507	IP10	€ 136,50	108	CART00023		€ 16,45	198
CARR03093	IP08	€ 613,90	150	CARR50507	IP09	€ 136,50	108	CART00024		€ 5,00	198
CARR03094	IP08	€ 660,30	152	CARR50507	IP04	€ 136,50	108	CART00025		€ 9,95	198
CARR03096	IP08	€ 770,00	154	CARR50508	IP15	€ 140,40	107	CART00026		€ 16,45	198
CARR03130	0099	€ 220,00	125	CARR50508	IP10	€ 140,40	107	CART00032		€ 36,95	198
CARR03159		€ 730,00	144	CARR50508	IP09	€ 140,40	107	CART00036		€ 92,00	243
CARR03163		€ 805,00	144	CARR50508	IP04	€ 140,40	107	CART00037		€ 152,00	243
CARR03165		€ 658,00	144	CARR50509	IP15	€ 140,40	107	CART00038		€ 102,00	243
CARR03166	IP98	€ 388,00	144	CARR50509	IP10	€ 140,40	107	CHVR00056		€ 1,12	138
CARR03171		€ 757,00	144	CARR50509	IP09	€ 140,40	107	CHVR00056		€ 1,12	159
CARR03172		€ 832,00	144	CARR50509	IP04	€ 140,40	107	CHVR00057		€ 8,25	137
CARR03173	IP98	€ 415,00	144	CARR50510	IP15	€ 141,40	107	CHVR00057		€ 8,25	158
CARR03174		€ 685,00	144	CARR50510	IP10	€ 141,40	107	CHVR00058		€ 8,25	138
CARR50121	IP06	€ 364,10	178	CARR50510	IP09	€ 141,40	107	CHVR00058		€ 8,25	159
CARR50234	IP99	€ 123,90	120	CARR50510	IP04	€ 141,40	107	CINT80009		€ 9,00	230
CARR50239	IP99	€ 123,90	120	CARR50511	IP15	€ 141,40	107	CINT80010		€ 3,35	230
CARR50378	IP06	€ 460,00	177	CARR50511	IP10	€ 141,40	107	CLIP70003	S ST	€ 0,11	233
CARR50390	IP06	€ 351,20	167	CARR50511	IP09	€ 141,40	107	CLIP80005	0009	€ 1,20	228
CARR50392	IP06	€ 286,40	171	CARR50511	IP04	€ 141,40	107	CLIP80006	0009	€ 1,20	228
CARR50400	IP06	€ 262,90	172	CARR50637	IP06	€ 332,80	168	COPL70199	S ST	€ 10,05	215
CARR50408	IP06	€ 312,80	174	CARR50666	IP06	€ 296,20	170	COMB00009		€ 169,10	241
CARR50423	IP15	€ 126,00	111	CARR51287		€ 219,80	121	COME00268	0008	€ 56,00	142
CARR50423	IP10	€ 126,00	111	CARR51293		€ 585,90	149	COME00268	0008	€ 56,00	164
CARR50423	IP09	€ 126,00	111	CARR51772	IP15	€ 160,00	112	COME00296		€ 87,90	84
CARR50423	IP04	€ 126,00	111	CARR51772	IP10	€ 160,00	112	COME00300		€ 19,80	88
CARR50424	IP15	€ 126,00	111	CARR51772	IP09	€ 160,00	112	COME00310	0008	€ 37,70	141
CARR50424	IP10	€ 126,00	111	CARR51772	IP04	€ 160,00	112	COME00310	0008	€ 37,70	163
CARR50424	IP09	€ 126,00	111	CARR51773	IP15	€ 160,00	112	COME00314	0008	€ 59,20	140
CARR50424	IP04	€ 126,00	111	CARR51773	IP10	€ 160,00	112	COME00314	0008	€ 59,20	161

CODE INDEX

CODE	DIGIT	UNIT PRICE	PAGE	CODE	DIGIT	UNIT PRICE	PAGE	CODE	DIGIT	UNIT PRICE	PAGE
COME00319	0006	€ 108,70	182	CONT00022	0199	€ 30,90	90	FRAN00981		€ 6,20	45
COME00329		€ 30,25	141	CONT00022	1599	€ 30,90	90	FRAN00982		€ 6,50	46
COME00329		€ 30,25	162	CONT00022	0299	€ 30,90	90	FRAN00983		€ 6,10	47
COME00332	0008	€ 15,85	163	CONT00022	0999	€ 30,90	90	FRAN00999	0003	€ 6,00	216
COME00333	0008	€ 15,85	163	CONT00022	0499	€ 30,90	90	FRAN01000	0003	€ 7,10	216
COME00334	0008	€ 14,85	142	CONT00023	0001	€ 93,40	91	FRAN01001	0003	€ 4,80	65
COME00334	0008	€ 14,85	163	CONT00024	0002	€ 25,90	91	FRAN01001	0003	€ 4,80	216
COME00335	0008	€ 14,85	142	COPL70200	S ST	€ 9,45	215	FRAN01035		€ 6,70	44
COME00335	0008	€ 14,85	163	COPL70204	S ST	€ 13,00	215	FRAN01046		€ 7,85	45
COME00339		€ 30,70	136	FRAN00008		€ 5,30	22	FRAN01061		€ 7,65	47
COME00383	0008	€ 33,00	142	FRAN00009		€ 7,00	22	FRAN01089		€ 5,20	49
COME00383		€ 33,00	164	FRAN00012		€ 9,15	22	FRAN01091		€ 6,20	49
COME00385		€ 15,00	142	FRAN00014		€ 12,20	22	FRAN01123		€ 12,20	55
COME00385		€ 15,00	164	FRAN00035		€ 8,15	22	FRAN01124		€ 16,25	55
CONT00004		€ 259,50	92	FRAN00036		€ 9,15	22	FRAN01156		€ 11,20	55
CONT00005		€ 50,65	92	FRAN00037		€ 11,20	22	FRAN01202	0001	€ 6,80	44
CONT00006		€ 197,10	92	FRAN00038		€ 13,60	22	FRAN01202	0005	€ 6,80	44
CONT00007		€ 89,00	251	FRAN00042		€ 22,95	23	FRAN01202	0002	€ 6,80	44
CONT00011	0001	€ 16,45	90	FRAN00044		€ 27,60	23	FRAN01202	0009	€ 6,80	44
CONT00011	0015	€ 16,45	90	FRAN00046		€ 32,10	23	FRAN01202	0004	€ 6,80	44
CONT00011	0002	€ 16,45	90	FRAN00134		€ 8,35	50	FRAN01204	0001	€ 8,85	44
CONT00011	0009	€ 16,45	90	FRAN00242		€ 5,00	216	FRAN01204	0005	€ 8,85	44
CONT00011	0004	€ 16,45	90	FRAN00243		€ 4,70	216	FRAN01204	0002	€ 8,85	44
CONT00011	0199	€ 15,45	90	FRAN00244		€ 6,20	216	FRAN01204	0009	€ 8,85	44
CONT00011	1599	€ 15,45	90	FRAN00322		€ 19,10	22	FRAN01204	0004	€ 8,85	44
CONT00011	0299	€ 15,45	90	FRAN00324		€ 22,45	22	FRAN01205	0001	€ 6,10	44
CONT00011	0999	€ 15,45	90	FRAN00325		€ 27,40	22	FRAN01205	0005	€ 6,10	44
CONT00011	0499	€ 15,45	90	FRAN00337		€ 21,55	22	FRAN01205	0002	€ 6,10	44
CONT00012	0001	€ 18,70	90	FRAN00339		€ 24,60	22	FRAN01205	0009	€ 6,10	44
CONT00012	0015	€ 18,70	90	FRAN00340		€ 27,40	22	FRAN01205	0004	€ 6,10	44
CONT00012	0002	€ 18,70	90	FRAN00342		€ 24,20	23	FRAN01207	0001	€ 8,25	44
CONT00012	0009	€ 18,70	90	FRAN00344		€ 28,75	23	FRAN01207	0005	€ 8,25	44
CONT00012	0004	€ 18,70	90	FRAN00348		€ 6,10	52	FRAN01207	0002	€ 8,25	44
CONT00012	0199	€ 17,50	90	FRAN00352		€ 6,90	52	FRAN01207	0009	€ 8,25	44
CONT00012	1599	€ 17,50	90	FRAN00401	0001	€ 8,85	50	FRAN01207	0004	€ 8,25	44
CONT00012	0299	€ 17,50	90	FRAN00465		€ 9,35	52	FRAN01208	0001	€ 7,75	44
CONT00012	0999	€ 17,50	90	FRAN00467		€ 10,50	52	FRAN01208	0005	€ 7,75	44
CONT00012	0499	€ 17,50	90	FRAN00469		€ 4,50	50	FRAN01208	0002	€ 7,75	44
CONT00013	0001	€ 29,15	90	FRAN00471		€ 9,95	50	FRAN01208	0009	€ 7,75	44
CONT00013	0015	€ 29,15	90	FRAN00472		€ 4,00	50	FRAN01208	0004	€ 7,75	44
CONT00013	0002	€ 29,15	90	FRAN00474		€ 5,80	50	FRAN01210	0001	€ 10,05	44
CONT00013	0009	€ 29,15	90	FRAN00476		€ 8,55	50	FRAN01210	0005	€ 10,05	44
CONT00013	0004	€ 29,15	90	FRAN00503	0001	€ 7,00	66	FRAN01210	0002	€ 10,05	44
CONT00013	0199	€ 27,90	90	FRAN00503	0005	€ 7,00	66	FRAN01210	0009	€ 10,05	44
CONT00013	1599	€ 27,90	90	FRAN00503	0002	€ 7,00	66	FRAN01210	0004	€ 10,05	44
CONT00013	0299	€ 27,90	90	FRAN00503	0003	€ 7,00	66	FRAN01211	0001	€ 7,15	45
CONT00013	0999	€ 27,90	90	FRAN00503	0004	€ 7,00	66	FRAN01211	0005	€ 7,15	45
CONT00013	0499	€ 27,90	90	FRAN00515		€ 5,50	51	FRAN01211	0002	€ 7,15	45
CONT00015	0001	€ 175,80	91	FRAN00518		€ 11,00	51	FRAN01211	0009	€ 7,15	45
CONT00015	0003	€ 175,80	91	FRAN00519		€ 4,80	51	FRAN01211	0004	€ 7,15	45
CONT00020	0015	€ 25,30	91	FRAN00522		€ 6,60	51	FRAN01213	0001	€ 9,25	45
CONT00021	0001	€ 22,95	90	FRAN00524		€ 8,85	51	FRAN01213	0005	€ 9,25	45
CONT00021	0015	€ 22,95	90	FRAN00609	0005	€ 4,80	66	FRAN01213	0002	€ 9,25	45
CONT00021	0002	€ 22,95	90	FRAN00609	0002	€ 4,80	66	FRAN01213	0009	€ 9,25	45
CONT00021	0009	€ 22,95	90	FRAN00609	0003	€ 4,80	66	FRAN01213	0004	€ 9,25	45
CONT00021	0004	€ 22,95	90	FRAN00609	0004	€ 4,80	66	FRAN01217	0001	€ 7,85	45
CONT00021	0199	€ 21,95	90	FRAN00615	0001	€ 5,60	216	FRAN01217	0005	€ 7,85	45
CONT00021	1599	€ 21,95	90	FRAN00652		€ 15,85	22	FRAN01217	0002	€ 7,85	45
CONT00021	0299	€ 21,95	90	FRAN00673		€ 19,40	22	FRAN01217	0009	€ 7,85	45
CONT00021	0999	€ 21,95	90	FRAN00686		€ 24,70	22	FRAN01217	0004	€ 7,85	45
CONT00021	0499	€ 21,95	90	FRAN00753		€ 6,80	51	FRAN01219	0001	€ 10,05	45
CONT00022	0001	€ 31,90	90	FRAN00862		€ 6,50	216	FRAN01219	0005	€ 10,05	45
CONT00022	0015	€ 31,90	90	FRAN00866		€ 8,25	46	FRAN01219	0002	€ 10,05	45
CONT00022	0002	€ 31,90	90	FRAN00902		€ 14,95	55	FRAN01219	0009	€ 10,05	45
CONT00022	0009	€ 31,90	90	FRAN00946	0001	€ 7,80	216	FRAN01219	0004	€ 10,05	45
CONT00022	0004	€ 31,90	90	FRAN00974		€ 5,60	44	FRAN01220	0001	€ 7,65	46

CODE INDEX

CODE	DIGIT	UNIT PRICE	PAGE	CODE	DIGIT	UNIT PRICE	PAGE	CODE	DIGIT	UNIT PRICE	PAGE
FRAN01220	0005	€ 7,65	46	FRAN01248	0002	€ 10,05	48	FRAN01316	0005	€ 8,15	50
FRAN01220	0002	€ 7,65	46	FRAN01248	0009	€ 10,05	48	FRAN01316	0002	€ 8,15	50
FRAN01220	0009	€ 7,65	46	FRAN01248	0004	€ 10,05	48	FRAN01316	0009	€ 8,15	50
FRAN01220	0004	€ 7,65	46	FRAN01249	0001	€ 5,80	49	FRAN01316	0004	€ 8,15	50
FRAN01222	0001	€ 10,30	46	FRAN01249	0005	€ 5,80	49	FRAN01318	0001	€ 10,80	50
FRAN01222	0005	€ 10,30	46	FRAN01249	0002	€ 5,80	49	FRAN01318	0005	€ 10,80	50
FRAN01222	0002	€ 10,30	46	FRAN01249	0009	€ 5,80	49	FRAN01318	0002	€ 10,80	50
FRAN01222	0009	€ 10,30	46	FRAN01249	0004	€ 5,80	49	FRAN01318	0009	€ 10,80	50
FRAN01222	0004	€ 10,30	46	FRAN01251	0001	€ 7,20	49	FRAN01318	0004	€ 10,80	50
FRAN01223	0001	€ 6,90	46	FRAN01251	0005	€ 7,20	49	FRAN01319		€ 7,15	51
FRAN01223	0005	€ 6,90	46	FRAN01251	0002	€ 7,20	49	FRAN01322	0001	€ 6,00	51
FRAN01223	0002	€ 6,90	46	FRAN01251	0009	€ 7,20	49	FRAN01322	0005	€ 6,00	51
FRAN01223	0009	€ 6,90	46	FRAN01251	0004	€ 7,20	49	FRAN01322	0002	€ 6,00	51
FRAN01223	0004	€ 6,90	46	FRAN01258		€ 6,30	44	FRAN01322	0009	€ 6,00	51
FRAN01225	0001	€ 9,25	46	FRAN01259		€ 7,85	44	FRAN01322	0004	€ 6,00	51
FRAN01225	0005	€ 9,25	46	FRAN01262		€ 9,75	44	FRAN01324	0001	€ 8,05	51
FRAN01225	0002	€ 9,25	46	FRAN01263		€ 12,00	44	FRAN01324	0005	€ 8,05	51
FRAN01225	0009	€ 9,25	46	FRAN01264		€ 6,60	45	FRAN01324	0002	€ 8,05	51
FRAN01225	0004	€ 9,25	46	FRAN01265		€ 8,55	45	FRAN01324	0009	€ 8,05	51
FRAN01226	0001	€ 8,45	46	FRAN01268		€ 10,60	45	FRAN01324	0004	€ 8,05	51
FRAN01226	0005	€ 8,45	46	FRAN01269		€ 13,30	45	FRAN01325	0001	€ 5,50	51
FRAN01226	0002	€ 8,45	46	FRAN01270		€ 7,00	46	FRAN01325	0005	€ 5,50	51
FRAN01226	0009	€ 8,45	46	FRAN01271		€ 9,25	46	FRAN01325	0002	€ 5,50	51
FRAN01226	0004	€ 8,45	46	FRAN01274		€ 11,00	46	FRAN01325	0009	€ 5,50	51
FRAN01228	0001	€ 11,00	46	FRAN01275		€ 13,80	46	FRAN01325	0004	€ 5,50	51
FRAN01228	0005	€ 11,00	46	FRAN01276		€ 8,25	47	FRAN01327	0001	€ 7,15	51
FRAN01228	0002	€ 11,00	46	FRAN01277		€ 10,60	47	FRAN01327	0005	€ 7,15	51
FRAN01228	0009	€ 11,00	46	FRAN01280		€ 10,60	47	FRAN01327	0002	€ 7,15	51
FRAN01228	0004	€ 11,00	46	FRAN01281		€ 13,30	47	FRAN01327	0009	€ 7,15	51
FRAN01229	0001	€ 8,65	47	FRAN01282		€ 7,65	48	FRAN01327	0004	€ 7,15	51
FRAN01229	0005	€ 8,65	47	FRAN01283		€ 10,05	48	FRAN01331		€ 7,45	51
FRAN01229	0002	€ 8,65	47	FRAN01292		€ 10,40	49	FRAN01332	0001	€ 7,25	51
FRAN01229	0009	€ 8,65	47	FRAN01293		€ 12,80	49	FRAN01332	0005	€ 7,25	51
FRAN01229	0004	€ 8,65	47	FRAN01297		€ 18,60	55	FRAN01332	0002	€ 7,25	51
FRAN01231	0001	€ 11,40	47	FRAN01301		€ 5,70	50	FRAN01332	0009	€ 7,25	51
FRAN01231	0005	€ 11,40	47	FRAN01304	0001	€ 5,10	50	FRAN01332	0004	€ 7,25	51
FRAN01231	0002	€ 11,40	47	FRAN01304	0005	€ 5,10	50	FRAN01334	0001	€ 9,85	51
FRAN01231	0009	€ 11,40	47	FRAN01304	0002	€ 5,10	50	FRAN01334	0005	€ 9,85	51
FRAN01231	0004	€ 11,40	47	FRAN01304	0009	€ 5,10	50	FRAN01334	0002	€ 9,85	51
FRAN01235	0001	€ 9,35	47	FRAN01304	0004	€ 5,10	50	FRAN01334	0009	€ 9,85	51
FRAN01235	0005	€ 9,35	47	FRAN01306	0001	€ 6,60	50	FRAN01334	0004	€ 9,85	51
FRAN01235	0002	€ 9,35	47	FRAN01306	0005	€ 6,60	50	FRAN01335	0001	€ 6,60	51
FRAN01235	0009	€ 9,35	47	FRAN01306	0002	€ 6,60	50	FRAN01335	0005	€ 6,60	51
FRAN01235	0004	€ 9,35	47	FRAN01306	0009	€ 6,60	50	FRAN01335	0002	€ 6,60	51
FRAN01237	0001	€ 12,30	47	FRAN01306	0004	€ 6,60	50	FRAN01335	0009	€ 6,60	51
FRAN01237	0005	€ 12,30	47	FRAN01307	0001	€ 4,30	50	FRAN01335	0004	€ 6,60	51
FRAN01237	0002	€ 12,30	47	FRAN01307	0005	€ 4,30	50	FRAN01337	0001	€ 7,45	51
FRAN01237	0009	€ 12,30	47	FRAN01307	0002	€ 4,30	50	FRAN01337	0005	€ 7,45	51
FRAN01237	0004	€ 12,30	47	FRAN01307	0009	€ 4,30	50	FRAN01337	0002	€ 7,45	51
FRAN01238	0001	€ 8,65	48	FRAN01307	0004	€ 4,30	50	FRAN01337	0009	€ 7,45	51
FRAN01238	0005	€ 8,65	48	FRAN01309	0001	€ 5,70	50	FRAN01337	0004	€ 7,45	51
FRAN01238	0002	€ 8,65	48	FRAN01309	0005	€ 5,70	50	FRAN01338	0001	€ 9,85	52
FRAN01238	0009	€ 8,65	48	FRAN01309	0002	€ 5,70	50	FRAN01338	0005	€ 9,85	52
FRAN01238	0004	€ 8,65	48	FRAN01309	0009	€ 5,70	50	FRAN01338	0002	€ 9,85	52
FRAN01240	0001	€ 11,40	48	FRAN01309	0004	€ 5,70	50	FRAN01338	0009	€ 9,85	52
FRAN01240	0005	€ 11,40	48	FRAN01313	0001	€ 8,75	50	FRAN01338	0004	€ 9,85	52
FRAN01240	0002	€ 11,40	48	FRAN01313	0005	€ 8,75	50	FRAN01340	0001	€ 12,80	52
FRAN01240	0009	€ 11,40	48	FRAN01313	0002	€ 8,75	50	FRAN01340	0005	€ 12,80	52
FRAN01240	0004	€ 11,40	48	FRAN01313	0009	€ 8,75	50	FRAN01340	0002	€ 12,80	52
FRAN01241	0001	€ 7,45	48	FRAN01313	0004	€ 8,75	50	FRAN01340	0009	€ 12,80	52
FRAN01241	0005	€ 7,45	48	FRAN01315	0001	€ 11,40	50	FRAN01340	0004	€ 12,80	52
FRAN01241	0002	€ 7,45	48	FRAN01315	0005	€ 11,40	50	FRAN01341	0001	€ 9,15	52
FRAN01241	0009	€ 7,45	48	FRAN01315	0002	€ 11,40	50	FRAN01341	0005	€ 9,15	52
FRAN01241	0004	€ 7,45	48	FRAN01315	0009	€ 11,40	50	FRAN01341	0002	€ 9,15	52
FRAN01248	0001	€ 10,05	48	FRAN01315	0004	€ 11,40	50	FRAN01341	0009	€ 9,15	52
FRAN01248	0005	€ 10,05	48	FRAN01316	0001	€ 8,15	50	FRAN01341	0004	€ 9,15	52

CODE INDEX

CODE	DIGIT	UNIT PRICE	PAGE	CODE	DIGIT	UNIT PRICE	PAGE	CODE	DIGIT	UNIT PRICE	PAGE
FRAN01343	0001	€ 14,00	52	FRAN01373	0002	€ 4,60	50	FRAN01510	0004	€ 10,60	43
FRAN01343	0005	€ 14,00	52	FRAN01373	0009	€ 4,60	50	FRAN01511	0005	€ 10,80	43
FRAN01343	0002	€ 14,00	52	FRAN01373	0004	€ 4,60	50	FRAN01511	0002	€ 10,80	43
FRAN01343	0009	€ 14,00	52	FRAN01374	0005	€ 4,90	50	FRAN01511	0009	€ 10,80	43
FRAN01343	0004	€ 14,00	52	FRAN01374	0002	€ 4,90	50	FRAN01511	0004	€ 10,80	43
FRAN01344	0001	€ 6,60	52	FRAN01374	0009	€ 4,90	50	FRAN01512	0001	€ 11,10	43
FRAN01344	0005	€ 6,60	52	FRAN01374	0004	€ 4,90	50	FRAN01512	0005	€ 11,10	43
FRAN01344	0002	€ 6,60	52	FRAN01375	0005	€ 5,70	51	FRAN01512	0002	€ 11,10	43
FRAN01344	0009	€ 6,60	52	FRAN01375	0002	€ 5,70	51	FRAN01512	0009	€ 11,10	43
FRAN01344	0004	€ 6,60	52	FRAN01375	0009	€ 5,70	51	FRAN01512	0004	€ 11,10	43
FRAN01346	0001	€ 8,85	52	FRAN01375	0004	€ 5,70	51	FRAN01514	0001	€ 12,30	43
FRAN01346	0005	€ 8,85	52	FRAN01376	0005	€ 5,90	51	FRAN01514	0005	€ 12,30	43
FRAN01346	0002	€ 8,85	52	FRAN01376	0002	€ 5,90	51	FRAN01514	0002	€ 12,30	43
FRAN01346	0009	€ 8,85	52	FRAN01376	0009	€ 5,90	51	FRAN01514	0009	€ 12,30	43
FRAN01346	0004	€ 8,85	52	FRAN01376	0004	€ 5,90	51	FRAN01514	0004	€ 12,30	43
FRAN01347	0001	€ 5,90	52	FRAN01408		€ 31,10	23	FRAN01515	0001	€ 10,50	43
FRAN01347	0005	€ 5,90	52	FRAN01409		€ 10,80	55	FRAN01515	0005	€ 10,50	43
FRAN01347	0002	€ 5,90	52	FRAN01474		€ 8,35	42	FRAN01515	0002	€ 10,50	43
FRAN01347	0009	€ 5,90	52	FRAN01475		€ 9,95	42	FRAN01515	0009	€ 10,50	43
FRAN01347	0004	€ 5,90	52	FRAN01476	0005	€ 8,45	42	FRAN01515	0004	€ 10,50	43
FRAN01349	0001	€ 8,15	52	FRAN01476	0002	€ 8,45	42	FRAN01517	0001	€ 12,10	43
FRAN01349	0005	€ 8,15	52	FRAN01476	0009	€ 8,45	42	FRAN01517	0005	€ 12,10	43
FRAN01349	0002	€ 8,15	52	FRAN01476	0004	€ 8,45	42	FRAN01517	0002	€ 12,10	43
FRAN01349	0009	€ 8,15	52	FRAN01477	0005	€ 8,65	42	FRAN01517	0009	€ 12,10	43
FRAN01349	0004	€ 8,15	52	FRAN01477	0002	€ 8,65	42	FRAN01517	0004	€ 12,10	43
FRAN01361	0005	€ 6,20	44	FRAN01477	0009	€ 8,65	42	FRAN01518	0001	€ 12,10	43
FRAN01361	0002	€ 6,20	44	FRAN01477	0004	€ 8,65	42	FRAN01518	0005	€ 12,10	43
FRAN01361	0009	€ 6,20	44	FRAN01478	0001	€ 8,85	42	FRAN01518	0002	€ 12,10	43
FRAN01361	0004	€ 6,20	44	FRAN01478	0005	€ 8,85	42	FRAN01518	0009	€ 12,10	43
FRAN01362	0005	€ 6,60	44	FRAN01478	0002	€ 8,85	42	FRAN01518	0004	€ 12,10	43
FRAN01362	0002	€ 6,60	44	FRAN01478	0009	€ 8,85	42	FRAN01520	0001	€ 13,40	43
FRAN01362	0009	€ 6,60	44	FRAN01478	0004	€ 8,85	42	FRAN01520	0005	€ 13,40	43
FRAN01362	0004	€ 6,60	44	FRAN01480	0001	€ 10,05	42	FRAN01520	0002	€ 13,40	43
FRAN01363	0005	€ 6,70	45	FRAN01480	0005	€ 10,05	42	FRAN01520	0009	€ 13,40	43
FRAN01363	0002	€ 6,70	45	FRAN01480	0002	€ 10,05	42	FRAN01520	0004	€ 13,40	43
FRAN01363	0009	€ 6,70	45	FRAN01480	0009	€ 10,05	42	FRAN01521		€ 8,85	43
FRAN01363	0004	€ 6,70	45	FRAN01480	0004	€ 10,05	42	FRAN01522		€ 12,20	43
FRAN01364	0005	€ 6,90	45	FRAN01481	0001	€ 8,35	42	FRAN01523		€ 15,75	43
FRAN01364	0002	€ 6,90	45	FRAN01481	0005	€ 8,35	42	FRAN01524		€ 19,00	43
FRAN01364	0009	€ 6,90	45	FRAN01481	0002	€ 8,35	42	FRAN01532		€ 26,90	241
FRAN01364	0004	€ 6,90	45	FRAN01481	0009	€ 8,35	42	FRAN01533		€ 26,90	241
FRAN01365	0005	€ 7,35	46	FRAN01481	0004	€ 8,35	42	FRAN01534		€ 26,90	241
FRAN01365	0002	€ 7,35	46	FRAN01483	0001	€ 9,95	42	FRAN01535		€ 26,90	241
FRAN01365	0009	€ 7,35	46	FRAN01483	0005	€ 9,95	42	FRAN01578	IP09	€ 5,30	237
FRAN01365	0004	€ 7,35	46	FRAN01483	0002	€ 9,95	42	FRAN01634		€ 8,75	40
FRAN01366	0005	€ 7,55	46	FRAN01483	0009	€ 9,95	42	FRAN01639		€ 7,55	41
FRAN01366	0002	€ 7,55	46	FRAN01483	0004	€ 9,95	42	FRAN01642		€ 7,00	41
FRAN01366	0009	€ 7,55	46	FRAN01484	0001	€ 9,85	42	FRAN01644		€ 6,80	41
FRAN01366	0004	€ 7,55	46	FRAN01484	0005	€ 9,85	42	FRAN01659		€ 6,00	40
FRAN01367	0005	€ 8,35	47	FRAN01484	0002	€ 9,85	42	FRAN01799	0005	€ 6,50	22
FRAN01367	0002	€ 8,35	47	FRAN01484	0009	€ 9,85	42	FRAN01800	0005	€ 8,45	22
FRAN01367	0009	€ 8,35	47	FRAN01484	0004	€ 9,85	42	FRAN01801	0005	€ 11,60	22
FRAN01367	0004	€ 8,35	47	FRAN01486	0001	€ 11,10	42	FRAN01802	0005	€ 15,25	22
FRAN01368	0005	€ 8,55	47	FRAN01486	0005	€ 11,10	42	FRAN02000		€ 6,30	39
FRAN01368	0002	€ 8,55	47	FRAN01486	0002	€ 11,10	42	FRAN02001		€ 6,30	39
FRAN01368	0009	€ 8,55	47	FRAN01486	0009	€ 11,10	42	FRAN02002		€ 6,30	39
FRAN01368	0004	€ 8,55	47	FRAN01486	0004	€ 11,10	42	FRAN02003		€ 6,30	39
FRAN01369	0005	€ 8,35	48	FRAN01487		€ 7,65	42	FRAN02004		€ 6,30	39
FRAN01369	0002	€ 8,35	48	FRAN01488		€ 11,10	42	FRAN02005		€ 6,30	39
FRAN01369	0009	€ 8,35	48	FRAN01489		€ 14,65	42	FRAN02020		€ 8,00	39
FRAN01369	0004	€ 8,35	48	FRAN01490		€ 17,70	42	FRAN02021		€ 8,00	39
FRAN01370	0005	€ 8,55	48	FRAN01508		€ 10,50	43	FRAN02022		€ 8,00	39
FRAN01370	0002	€ 8,55	48	FRAN01509		€ 12,10	43	FRAN02023		€ 8,00	39
FRAN01370	0009	€ 8,55	48	FRAN01510	0005	€ 10,60	43	FRAN02024		€ 8,00	39
FRAN01370	0004	€ 8,55	48	FRAN01510	0002	€ 10,60	43	FRAN02025		€ 8,00	39
FRAN01373	0005	€ 4,60	50	FRAN01510	0009	€ 10,60	43	FRAN02030		€ 11,20	39

CODE INDEX

CODE	DIGIT	UNIT PRICE	PAGE	CODE	DIGIT	UNIT PRICE	PAGE	CODE	DIGIT	UNIT PRICE	PAGE
FRAN02031		€ 11,20	39	KTRI06975	0002	€ 7,15	195	MANI00008		€ 3,80	63
FRAN02032		€ 11,20	39	KTRI06975	0009	€ 7,15	195	MANI00009		€ 4,10	63
FRAN02033		€ 11,20	39	KTRI06975	0004	€ 7,15	195	MANI00010		€ 4,70	24
FRAN02034		€ 11,20	39	KTRI06977	0015	€ 6,60	197	MANI00029	0015	€ 6,20	63
FRAN02035		€ 11,20	39	KTRI06977	0002	€ 6,60	197	MANI00029	0002	€ 6,20	63
FRAN02040		€ 14,10	39	KTRI06977	0009	€ 6,60	197	MANI00029	0009	€ 6,20	63
FRAN02041		€ 14,10	39	KTRI06977	0004	€ 6,60	197	MANI00029	0004	€ 6,20	63
FRAN02042		€ 14,10	39	KTRI06979	0015	€ 3,60	196	MANI00030	0015	€ 6,90	63
FRAN02043		€ 14,10	39	KTRI06979	0002	€ 3,60	196	MANI00030	0002	€ 6,90	63
FRAN02044		€ 14,10	39	KTRI06979	0009	€ 3,60	196	MANI00030	0009	€ 6,90	63
FRAN02045		€ 14,10	39	KTRI06979	0004	€ 3,60	196	MANI00030	0004	€ 6,90	63
IMPU00001		€ 16,00	232	KTRI54734		€ 165,90	124	MANI00032	0005	€ 11,20	63
IMPU00002		€ 19,20	232	KTRI99670		€ 1,22	84	MANI00032	0002	€ 11,20	63
IMPU00003		€ 10,20	232	KTRI99673		€ 1,12	33	MANI00032	0009	€ 11,20	63
IMPU00004		€ 6,00	233	LAFN11596		€ 22,50	141	MANI00032	0004	€ 11,20	63
IMPU70046	ST6 23ST	€ 1,52	234	LAFN11596		€ 22,50	162	MANI00033	0005	€ 10,50	63
IMPU70051	NOX 30ST	€ 6,70	233	LAFN11597		€ 30,00	142	MANI00033	0002	€ 10,50	63
IMPU70053		€ 6,80	233	LAFN11597		€ 30,00	164	MANI00033	0009	€ 10,50	63
IMPU80078		€ 8,30	230	LAFN11599		€ 30,00	138	MANI00033	0004	€ 10,50	63
IMPU80200	IPIA	€ 27,60	228	LAFN11599		€ 30,00	159	MANI00035	0009	€ 11,50	63
KTRI01548		€ 21,95	163	LAFN20294		€ 11,80	29	MANI00038	0006	€ 7,65	195
KTRI04725		€ 100,80	208	LAFN99610		€ 87,90	176	MANI00039	0006	€ 8,55	197
KTRI04728		€ 80,30	208	LAFN99613		€ 11,00	170	MANI00040	0015	€ 8,35	196
KTRI04734		€ 150,80	124	LAFN99613		€ 11,00	185	MANI00040	0002	€ 8,35	196
KTRI04735		€ 107,70	124	LAFN99614		€ 9,75	170	MANI00040	0009	€ 8,35	196
KTRI04784	0099	€ 12,40	141	LAFN99614		€ 9,75	181	MANI00040	0004	€ 8,35	196
KTRI04784	0006	€ 13,50	162	LAFN99623		€ 19,90	134	MANI00054	0005	€ 15,55	24
KTRI04843		€ 17,70	142	LAFN99624		€ 12,05	170	MANI00054	0002	€ 15,55	24
KTRI05036		€ 17,70	162	LAFN99624		€ 12,05	181	MANI00054	0003	€ 15,55	24
KTRI05106		€ 20,80	222	LAFN99643		€ 5,50	84	MANI00054	0004	€ 15,55	24
KTRI05213		€ 6,00	140	LAFN99688		€ 8,85	88	MANO00002	0006	€ 0,82	195
KTRI05213		€ 6,00	162	LAFN99726		17,5	132	MANO00002	0006	€ 0,82	197
KTRI05214		€ 6,00	140	LAFN99727		17,5	132	MANO00003	0015	€ 0,82	21
KTRI05214		€ 6,00	162	LAGR99703		€ 31,30	175	MANO00003	0002	€ 0,82	21
KTRI05222		€ 145,40	124	LAGR99716		€ 21,95	188	MANO00003	0009	€ 0,82	21
KTRI05247	0006	€ 4,50	133	LAMA00003		€ 0,75	240	MANO00003	0004	€ 0,82	21
KTRI05329		€ 101,40	210	LAMA00006		€ 2,85	239	MANO00003	0015	€ 0,82	63
KTRI05330		€ 364,20	210	LAMA70014	S ST	€ 1,43	239	MANO00003	0002	€ 0,82	63
KTRI05331		€ 399,40	211	LAMA70015	S ST	€ 17,20	239	MANO00003	0009	€ 0,82	63
KTRI05332		€ 402,80	212	LAMU00003		€ 9,75	99	MANO00003	0004	€ 0,82	63
KTRI06019		€ 20,40	62	LAMU00004		€ 11,00	194	MANO00003	0009	€ 0,82	63
KTRI06020		€ 22,60	62	LAMU00005		8,85	132	MANO00003	0009	€ 0,82	63
KTRI06021		€ 22,40	62	LAMU00005		€ 8,85	194	MANO00003	0015	€ 0,82	196
KTRI06022		€ 24,60	62	LAMU00021		€ 8,95	142	MANO00003	0002	€ 0,82	196
KTRI06032		€ 27,80	192	LAMU00021		€ 8,95	163	MANO00003	0009	€ 0,82	196
KTRI06066	0099	€ 96,50	139	LGMIO0001		€ 3,40	232	MANO00003	0004	€ 0,82	196
KTRI06066	0008	€ 112,00	160	LGMIO0002		€ 7,60	232	MOLL00002		€ 3,70	195
KTRI06259	0005	€ 84,40	207	LGMIO0003		€ 4,30	234	MOPP00003	0015	€ 2,25	58
KTRI06260	0081	€ 27,50	142	LGMIO0004		€ 3,70	232	MOPP00003	0002	€ 2,25	58
KTRI06260	0081	€ 27,50	164	LGMIO0005		€ 4,10	232	MOPP00003	0009	€ 2,25	58
KTRI06956		€ 10,90	195	LGMIO0006		€ 3,90	232	MOPP00003	0004	€ 2,25	58
KTRI06957		€ 19,30	195	LGMIO0007		€ 1,63	234	MOPP00003	0001	€ 2,25	58
KTRI06958		€ 21,95	197	LGMIO0008		€ 1,93	234	MOPP00004	0015	€ 2,75	58
KTRI06959		€ 5,10	197	LGMIO0009		€ 2,35	234	MOPP00004	0002	€ 2,75	58
KTRI06960		€ 12,00	197	LGMIO0010		€ 3,15	234	MOPP00004	0009	€ 2,75	58
KTRI06961		€ 28,55	197	LGMIO0011		€ 1,73	234	MOPP00004	0004	€ 2,75	58
KTRI06962		€ 5,10	196	LGMIO0012		€ 2,15	234	MOPP00004	0001	€ 2,75	58
KTRI06963		€ 4,30	196	LGMIO0013		€ 2,85	234	MOPP00005	0015	€ 3,15	58
KTRI06964		€ 15,45	196	MANI00001	0009	€ 7,65	21	MOPP00005	0002	€ 3,15	58
KTRI06966		€ 1,83	197	MANI00001	0009	€ 7,65	63	MOPP00005	0009	€ 3,15	58
KTRI06969		€ 0,72	21	MANI00002	0009	€ 8,45	21	MOPP00005	0004	€ 3,15	58
KTRI06975	IP15	€ 7,15	195	MANI00002	0009	€ 8,45	63	MOPP00005	0001	€ 3,15	58
KTRI06975	IP02	€ 7,15	195	MANI00004	0009	€ 26,40	20	MOPP00010	0001	€ 3,70	56
KTRI06975	IP09	€ 7,15	195	MANI00005	0002	€ 2,85	63	MOPP00013	0001	€ 4,00	56
KTRI06975	IP04	€ 7,15	195	MANI00006		€ 3,80	63	MOPP00016	0001	€ 4,40	56
KTRI06975	0015	€ 7,15	195	MANI00007		€ 4,10	63	MOPP00020	0001	€ 4,80	56

CODE INDEX

CODE	DIGIT	UNIT PRICE	PAGE	CODE	DIGIT	UNIT PRICE	PAGE	CODE	DIGIT	UNIT PRICE	PAGE
MOPP00026	0015	€ 2,35	58	MOPP00151	0001	€ 3,90	57	MOPP00332		€ 16,85	68
MOPP00026	0002	€ 2,35	58	MOPP00154	0001	€ 4,00	57	MOPP00343		€ 23,15	71
MOPP00026	0009	€ 2,35	58	MOPP00156	0001	€ 4,20	57	MPVR04764	0006	€ 16,05	132
MOPP00026	0004	€ 2,35	58	MOPP00165	0015	€ 2,75	58	MPVR04769	0099	€ 3,35	136
MOPP00026	0001	€ 2,35	58	MOPP00165	0002	€ 2,75	58	MPVR04769	0006	€ 3,90	157
MOPP00028	0015	€ 3,05	58	MOPP00165	0009	€ 2,75	58	MPVR04769	0008	€ 3,90	157
MOPP00028	0002	€ 3,05	58	MOPP00165	0004	€ 2,75	58	MPVR04771	0013	€ 0,51	136
MOPP00028	0009	€ 3,05	58	MOPP00165	0001	€ 2,75	58	MPVR04771	0008	€ 0,61	157
MOPP00028	0004	€ 3,05	58	MOPP00167	0015	€ 3,05	58	MPVR04772	0013	€ 0,51	136
MOPP00028	0001	€ 3,05	58	MOPP00167	0002	€ 3,05	58	MPVR04772	0008	€ 0,61	158
MOPP00029	0015	€ 3,25	58	MOPP00167	0009	€ 3,05	58	MPVR04773	0013	€ 1,45	136
MOPP00029	0002	€ 3,25	58	MOPP00167	0004	€ 3,05	58	MPVR04773	0008	€ 1,45	156
MOPP00029	0009	€ 3,25	58	MOPP00167	0001	€ 3,05	58	MPVR04775	0013	€ 0,41	136
MOPP00029	0004	€ 3,25	58	MOPP00168	0015	€ 3,35	58	MPVR04775	0008	€ 0,51	156
MOPP00029	0001	€ 3,25	58	MOPP00168	0002	€ 3,35	58	MPVR04776	0099	€ 0,56	137
MOPP00030	0015	€ 3,60	58	MOPP00168	0009	€ 3,35	58	MPVR04776	0008	€ 0,66	158
MOPP00030	0002	€ 3,60	58	MOPP00168	0004	€ 3,35	58	MPVR04778	0099	€ 3,35	136
MOPP00030	0009	€ 3,60	58	MOPP00168	0001	€ 3,35	58	MPVR04778	0006	€ 3,90	157
MOPP00030	0004	€ 3,60	58	MOPP00170	0015	€ 2,75	58	MPVR04778	0008	€ 3,90	157
MOPP00030	0001	€ 3,60	58	MOPP00170	0002	€ 2,75	58	MPVR04779	0599	€ 16,25	138
MOPP00037	0001	€ 4,30	56	MOPP00170	0009	€ 2,75	58	MPVR04779	0299	€ 16,25	138
MOPP00040	0001	€ 4,50	56	MOPP00170	0004	€ 2,75	58	MPVR04779	0499	€ 16,25	138
MOPP00042	0001	€ 5,00	56	MOPP00170	0001	€ 2,75	58	MPVR04779	0999	€ 16,25	138
MOPP00044	0001	€ 5,40	56	MOPP00173	0015	€ 3,05	58	MPVR04779	0506	€ 20,10	159
MOPP00048	0001	€ 5,00	56	MOPP00173	0002	€ 3,05	58	MPVR04779	0206	€ 20,10	159
MOPP00049	0001	€ 5,70	56	MOPP00173	0009	€ 3,05	58	MPVR04779	0906	€ 20,10	159
MOPP00050	0001	€ 6,30	56	MOPP00173	0004	€ 3,05	58	MPVR04779	0406	€ 20,10	159
MOPP00051	0001	€ 7,00	56	MOPP00173	0001	€ 3,05	58	MPVR04794	0013	€ 11,90	137
MOPP00059	0001	€ 5,50	56	MOPP00188		€ 13,10	74	MPVR04794	0070	€ 15,95	137
MOPP00061	0001	€ 6,10	56	MOPP00189		€ 13,10	74	MPVR04794	0008	€ 15,05	158
MOPP00062	0001	€ 6,80	56	MOPP00191		€ 19,60	74	MPVR04794	0070	€ 15,95	158
MOPP00063	0001	€ 7,45	56	MOPP00192		€ 19,60	74	MPVR10546		€ 2,95	139
MOPP00069	0001	€ 18,00	75	MOPP00195		€ 26,70	74	MPVR10546		€ 2,95	160
MOPP00070	0001	€ 28,55	75	MOPP00196		€ 26,70	74	MPVR10647		€ 14,25	139
MOPP00077	0001	€ 4,40	56	MOPP00200		€ 10,60	72	MPVR10647		€ 14,25	161
MOPP00078	0001	€ 4,70	56	MOPP00202		€ 15,15	72	MPVR10649	0006	€ 3,35	139
MOPP00099	0015	€ 3,80	58	MOPP00203		€ 15,15	72	MPVR10649	0006	€ 3,35	161
MOPP00099	0002	€ 3,80	58	MOPP00206		€ 19,60	72	MPVR10664	0099	€ 11,00	136
MOPP00099	0009	€ 3,80	58	MOPP00207		€ 19,60	72	MPVR10673	0008	€ 46,00	157
MOPP00099	0004	€ 3,80	58	MOPP00213		€ 14,20	73	MPVR10679	0008	€ 3,90	162
MOPP00099	0001	€ 3,80	58	MOPP00217		€ 21,45	73	MPVR10680	0008	€ 12,40	138
MOPP00101	0005	€ 8,25	59	MOPP00221		€ 28,55	73	MPVR10681	0008	€ 0,72	138
MOPP00102	0005	€ 13,10	57	MOPP00222		€ 28,55	73	MPVR10683	0008	€ 1,02	138
MOPP00143	0015	€ 2,45	59	MOPP00228		€ 10,80	68	MPVR10849	0008	€ 0,72	138
MOPP00143	0002	€ 2,45	59	MOPP00229		€ 14,00	68	MPVR10852	0008	€ 10,30	162
MOPP00143	0009	€ 2,45	59	MOPP00246		€ 10,60	72	MPVR10853	0008	€ 12,40	138
MOPP00143	0004	€ 2,45	59	MOPP00257		€ 10,80	68	MPVR10854	0008	€ 5,90	134
MOPP00143	0001	€ 2,45	59	MOPP00302		€ 14,20	73	MPVR10854	0008	€ 5,90	141
MOPP00144	0001	€ 3,70	57	MOPP00303		€ 21,45	73	MPVR10854	0008	€ 5,90	163
MOPP00145	0001	€ 3,90	57	MOPP00305		€ 14,35	70	MPVR10854	0008	€ 5,90	184
MOPP00146	0001	€ 4,20	57	MOPP00306		€ 19,10	70	MPVR10854	0008	€ 5,90	189
MOPP00148	0015	€ 2,45	59	MOPP00307		€ 26,90	70	MPVR10855	0208	€ 111,70	155
MOPP00148	0002	€ 2,45	59	MOPP00308		€ 14,35	70	MPVR10855	0408	€ 111,70	155
MOPP00148	0009	€ 2,45	59	MOPP00309		€ 19,10	70	MPVR10855	0508	€ 111,70	155
MOPP00148	0004	€ 2,45	59	MOPP00310		€ 26,90	70	MPVR10855	0908	€ 111,70	155
MOPP00148	0001	€ 2,45	59	MOPP00311		€ 9,85	69	MPVR10855	0213	€ 111,70	155
MOPP00149	0015	€ 2,85	59	MOPP00312		€ 12,60	69	MPVR10855	0413	€ 111,70	155
MOPP00149	0002	€ 2,85	59	MOPP00313		€ 14,35	69	MPVR10855	0513	€ 111,70	155
MOPP00149	0009	€ 2,85	59	MOPP00314		€ 9,85	69	MPVR10855	0913	€ 111,70	155
MOPP00149	0004	€ 2,85	59	MOPP00315		€ 12,60	69	MPVR11495	0099	€ 64,60	138
MOPP00149	0001	€ 2,85	59	MOPP00316		€ 14,35	69	MPVR11495	0008	€ 72,20	159
MOPP00150	0015	€ 3,15	59	MOPP00319		€ 28,55	71	MPVR11505	0008	€ 2,30	158
MOPP00150	0002	€ 3,15	59	MOPP00320		€ 15,85	71	MPVR11725		€ 39,40	142
MOPP00150	0009	€ 3,15	59	MOPP00321		€ 34,90	71	MPVR11725		€ 39,40	164
MOPP00150	0004	€ 3,15	59	MOPP00330		€ 14,00	68	MPVR11730		€ 6,30	222
MOPP00150	0001	€ 3,15	59	MOPP00331		€ 16,85	68	MPVR11774	0013	€ 31,70	138

CODE INDEX

CODE	DIGIT	UNIT PRICE	PAGE	CODE	DIGIT	UNIT PRICE	PAGE	CODE	DIGIT	UNIT PRICE	PAGE
MPVR11774	0013	€ 31,70	159	MPVR94552	0015	€ 22,95	106	MPVR94594	0001	€ 7,45	86
MPVR11876	0099	€ 3,35	136	MPVR94552	0002	€ 22,95	106	MPVR94594	0099	€ 5,60	141
MPVR11876	0006	€ 3,90	157	MPVR94552	0003	€ 22,95	106	MPVR94594	0006	€ 7,45	162
MPVR11980	0013	€ 0,51	136	MPVR94552	0004	€ 22,95	106	MPVR94594	0006	€ 7,45	185
MPVR12006	0015	€ 3,25	61	MPVR94554	0005	€ 18,00	105	MPVR94594	0006	€ 7,45	191
MPVR12006	0002	€ 3,25	61	MPVR94554	0002	€ 18,00	105	MPVR94595	0006	€ 13,90	177
MPVR12006	0009	€ 3,25	61	MPVR94554	0002	€ 18,00	113	MPVR94595	0006	€ 13,90	189
MPVR12006	0004	€ 3,25	61	MPVR94554	0002	€ 18,00	113	MPVR94597	0018	€ 29,35	184
MPVR12982	IP09	€ 3,25	57	MPVR94554	0002	€ 18,00	114	MPVR94597	0018	€ 29,35	189
MPVR12982	IP15	€ 3,25	57	MPVR94555	0015	€ 18,00	84	MPVR94598	0015	€ 11,30	184
MPVR12983	IP09	€ 8,85	57	MPVR94555	0002	€ 18,00	84	MPVR94598	0015	€ 11,30	189
MPVR12983	IP15	€ 8,85	57	MPVR94555	0009	€ 18,00	84	MPVR94599	0099	€ 4,30	134
MPVR94 367		€ 5,40	84	MPVR94555	0004	€ 18,00	84	MPVR94599	0006	€ 5,30	172
MPVR94 367		€ 5,40	88	MPVR94556	0015	€ 19,30	87	MPVR94599	0006	€ 5,30	173
MPVR94354	IP15	€ 8,85	57	MPVR94556	0002	€ 19,30	87	MPVR94599	0006	€ 5,30	174
MPVR94358	0070	€ 2,75	190	MPVR94556	0009	€ 19,30	87	MPVR94599	0006	€ 5,30	177
MPVR94359	0006	€ 3,60	99	MPVR94556	0004	€ 19,30	87	MPVR94599	0006	€ 5,30	178
MPVR94360	0006	€ 5,50	98	MPVR94557	0006	€ 7,15	84	MPVR94599	0006	€ 5,30	179
MPVR94361	0006	€ 7,25	97	MPVR94559	0006	€ 5,50	174	MPVR94599	0015	€ 5,30	183
MPVR94367		€ 5,50	84	MPVR94559	0006	€ 5,50	185	MPVR94599	0010	€ 5,30	183
MPVR94367		€ 5,50	87	MPVR94560	0006	€ 9,45	167	MPVR94599	0009	€ 5,30	183
MPVR94368		€ 1,32	88	MPVR94560	0006	€ 9,45	169	MPVR94599	0004	€ 5,30	183
MPVR94369		€ 4,40	194	MPVR94560	0006	€ 9,45	175	MPVR94599	0006	€ 5,30	183
MPVR94375	0006	€ 13,40	192	MPVR94560	0006	€ 9,45	185	MPVR94599	0006	€ 5,30	190
MPVR94376	0006	€ 2,45	192	MPVR94569	0015	€ 1,22	84	MPVR94602	0006	€ 10,30	166
MPVR94380	0013	€ 24,20	27	MPVR94571	0015	€ 1,02	88	MPVR94602	0006	€ 10,30	168
MPVR94381	0013	€ 0,51	27	MPVR94574	0006	€ 1,02	132	MPVR94602	0006	€ 10,30	170
MPVR94381	0013	€ 0,51	27	MPVR94574	0006	€ 1,02	132	MPVR94602	0006	€ 10,30	171
MPVR94382	0013	€ 41,20	27	MPVR94574	0006	€ 1,02	133	MPVR94602	0006	€ 10,30	172
MPVR94398	0006	€ 12,70	195	MPVR94575	0001	€ 0,72	88	MPVR94602	0006	€ 10,30	173
MPVR94399	0006	€ 11,00	196	MPVR94577	0006	€ 1,93	195	MPVR94602	0006	€ 10,30	178
MPVR94401	0006	€ 20,40	197	MPVR94577	0006	€ 1,93	197	MPVR94602	0006	€ 10,30	185
MPVR94431		€ 0,11	203	MPVR94580	0006	€ 0,82	177	MPVR94602	0006	€ 10,30	189
MPVR94472		€ 4,80	195	MPVR94580	0006	€ 0,82	178	MPVR94603	0006	€ 7,35	86
MPVR94474		€ 0,51	195	MPVR94580	0006	€ 0,82	179	MPVR94603	0015	€ 7,35	86
MPVR94474		€ 0,51	197	MPVR94580	0006	€ 0,82	186	MPVR94603	0001	€ 7,35	86
MPVR94484	0006	€ 6,70	196	MPVR94584	0006	€ 1,02	134	MPVR94603	0015	€ 7,35	113
MPVR94488	0006	€ 0,51	196	MPVR94584	0009	€ 1,02	166	MPVR94603	0010	€ 7,35	113
MPVR94518	0001	€ 4,10	90	MPVR94584	0009	€ 1,02	167	MPVR94603	0009	€ 7,35	113
MPVR94518	0001	€ 4,10	90	MPVR94584	0009	€ 1,02	168	MPVR94603	0004	€ 7,35	113
MPVR94519	0001	€ 4,70	90	MPVR94584	0009	€ 1,02	169	MPVR94603	0015	€ 7,35	113
MPVR94519	0001	€ 4,70	90	MPVR94584	0009	€ 1,02	170	MPVR94603	0010	€ 7,35	113
MPVR94522	0099	€ 9,80	134	MPVR94584	0009	€ 1,02	171	MPVR94603	0009	€ 7,35	113
MPVR94522	0006	€ 11,00	182	MPVR94584	0009	€ 1,02	172	MPVR94603	0004	€ 7,35	113
MPVR94522	0006	€ 11,00	188	MPVR94584	0009	€ 1,02	173	MPVR94603	0015	€ 7,35	114
MPVR94523	0006	€ 17,00	187	MPVR94584	0009	€ 1,02	174	MPVR94603	0010	€ 7,35	114
MPVR94524	0006	€ 17,50	187	MPVR94584	0009	€ 1,02	175	MPVR94603	0009	€ 7,35	114
MPVR94539	IP15	€ 3,25	57	MPVR94584	0009	€ 1,02	177	MPVR94603	0004	€ 7,35	114
MPVR94539	0002	€ 3,25	57	MPVR94584	0009	€ 1,02	178	MPVR94603	0006	€ 7,35	185
MPVR94539	0009	€ 3,25	57	MPVR94584	0009	€ 1,02	179	MPVR94603	0006	€ 7,35	189
MPVR94539	0004	€ 3,25	57	MPVR94584	0009	€ 1,02	180	MPVR94604	0006	€ 0,82	174
MPVR94539	IP06	€ 3,25	57	MPVR94584	0009	€ 1,02	186	MPVR94604	0006	€ 0,82	186
MPVR94540	0009	€ 0,41	21	MPVR94584	0006	€ 1,02	203	MPVR94605	0006	€ 1,43	186
MPVR94540	0027	€ 0,41	21	MPVR94588	0006	€ 31,40	177	MPVR94606	0006	€ 1,53	186
MPVR94541	0009	€ 0,92	21	MPVR94588	0006	€ 31,40	178	MPVR94607	0006	€ 27,40	179
MPVR94551	0015	€ 19,30	87	MPVR94588	0006	€ 31,40	179	MPVR94607	0006	€ 27,40	189
MPVR94551	0002	€ 19,30	87	MPVR94588	0006	€ 31,40	191	MPVR94608	0006	€ 13,30	179
MPVR94551	0015	€ 19,30	89	MPVR94590	0006	€ 5,70	178	MPVR94608	0006	€ 13,30	191
MPVR94551	0002	€ 19,30	89	MPVR94593	0006	€ 10,50	134	MPVR94609	0006	€ 1,63	179
MPVR94551	0015	€ 19,30	106	MPVR94593	0006	€ 10,50	177	MPVR94609	0006	€ 1,63	191
MPVR94551	0002	€ 19,30	106	MPVR94593	0006	€ 10,50	178	MPVR94610	0006	€ 0,31	179
MPVR94552	0015	€ 22,95	104	MPVR94593	0006	€ 10,50	179	MPVR94610	0006	€ 0,31	191
MPVR94552	0002	€ 22,95	104	MPVR94593	0006	€ 10,50	182	MPVR94611	0006	€ 28,55	189
MPVR94552	0003	€ 22,95	104	MPVR94593	0006	€ 10,50	188	MPVR94612	0006	€ 9,95	190
MPVR94552	0004	€ 22,95	104	MPVR94594	0006	€ 7,45	86	MPVR94615	0006	€ 5,90	166
MPVR94552	0006	€ 22,95	105	MPVR94594	0015	€ 7,45	86	MPVR94615	0006	€ 5,90	167

CODE INDEX

CODE	DIGIT	UNIT PRICE	PAGE	CODE	DIGIT	UNIT PRICE	PAGE	CODE	DIGIT	UNIT PRICE	PAGE
MPVR94615	0006	€ 5,90	168	MPVR94676	0006	€ 5,80	84	MPVR94778	0006	€ 3,35	133
MPVR94615	0006	€ 5,90	169	MPVR94676	0006	€ 5,80	86	MPVR94816	0099	€ 17,50	139
MPVR94615	0006	€ 5,90	170	MPVR94676	0015	€ 5,80	86	MPVR94816	0008	€ 27,40	160
MPVR94615	0006	€ 5,90	171	MPVR94676	0001	€ 5,80	86	MPVR94818	0006	€ 2,03	136
MPVR94615	0006	€ 5,90	175	MPVR94676	0006	€ 5,80	139	MPVR94818	0006	€ 2,03	158
MPVR94615	0006	€ 5,90	183	MPVR94676	0006	€ 5,80	160	MPVR94819	0006	€ 4,50	139
MPVR94616	0006	€ 7,35	167	MPVR94677	0006	€ 5,50	84	MPVR94819	0008	€ 4,50	161
MPVR94616	0006	€ 7,35	175	MPVR94677	0006	€ 5,50	86	MPVR94820	0013	€ 4,40	136
MPVR94616	0006	€ 7,35	182	MPVR94677	0015	€ 5,50	86	MPVR94820	0008	€ 6,40	157
MPVR94617	0006	€ 7,15	167	MPVR94677	0001	€ 5,50	86	MPVR94821	0008	€ 1,02	137
MPVR94617	0006	€ 7,15	169	MPVR94680	0006	€ 1,32	136	MPVR94821	0008	€ 1,02	158
MPVR94617	0006	€ 7,15	175	MPVR94680	0006	€ 1,32	158	MPVR94822	0008	€ 1,02	137
MPVR94619	0006	€ 7,45	107	MPVR94682	0005	€ 19,20	27	MPVR94822	0008	€ 1,02	159
MPVR94619	0006	€ 7,45	107	MPVR94685	0003	€ 2,85	238	MPVR94823	0099	€ 1,58	137
MPVR94619	0006	€ 7,45	108	MPVR94686	0003	€ 3,05	238	MPVR94823	0008	€ 1,70	158
MPVR94619	0006	€ 7,45	108	MPVR94687	0003	€ 1,43	238	MPVR94828	0099	€ 1,80	137
MPVR94619	0006	7,45	132	MPVR94688	0003	€ 1,53	238	MPVR94828	0008	€ 2,30	158
MPVR94622	0099	€ 21,45	134	MPVR94704	0006	€ 0,51	134	MPVR94835	0099	€ 3,70	138
MPVR94623	0006	€ 4,50	190	MPVR94704	0006	€ 0,51	136	MPVR94835	0008	€ 4,30	160
MPVR94624	0006	€ 6,00	190	MPVR94704	0006	€ 0,51	156	MPVR94836	0099	€ 6,50	141
MPVR94625	0006	€ 5,50	190	MPVR94704	0006	€ 0,51	166	MPVR94836	0008	€ 12,00	162
MPVR94626	0006	€ 59,20	179	MPVR94704	0006	€ 0,51	167	MPVR94837	0013	€ 9,95	139
MPVR94626	0006	€ 59,20	191	MPVR94704	0006	€ 0,51	168	MPVR94837	0008	€ 9,95	161
MPVR94627	0006	€ 18,60	179	MPVR94704	0006	€ 0,51	169	MPVR94838	0013	€ 10,80	137
MPVR94627	0006	€ 18,60	191	MPVR94704	0006	€ 0,51	170	MPVR94838	0070	€ 14,85	137
MPVR94629	0006	€ 1,12	90	MPVR94704	0006	€ 0,51	171	MPVR94838	0008	€ 13,90	158
MPVR94629	0006	€ 1,12	90	MPVR94704	0006	€ 0,51	172	MPVR94838	0070	€ 14,85	158
MPVR94629	0006	€ 1,12	188	MPVR94704	0006	€ 0,51	173	MPVR94839	0099	€ 4,00	137
MPVR94630	0006	€ 5,50	188	MPVR94704	0006	€ 0,51	174	MPVR94839	0008	€ 5,50	158
MPVR94631	0099	€ 4,50	134	MPVR94704	0006	€ 0,51	175	MPVR94840	0013	€ 7,15	141
MPVR94631	0006	€ 10,20	182	MPVR94704	0006	€ 0,51	180	MPVR94840	0008	€ 7,65	162
MPVR94633	0006	€ 1,02	134	MPVR94704	0006	€ 0,51	203	MPVR94841	0613	€ 7,45	137
MPVR94633	0006	€ 1,02	139	MPVR94748	0015	€ 2,35	195	MPVR94841	0670	€ 8,55	137
MPVR94633	0008	€ 1,02	160	MPVR94748	0002	€ 2,35	195	MPVR94841	0608	€ 7,45	158
MPVR94633	0006	€ 1,02	182	MPVR94748	0009	€ 2,35	195	MPVR94841	0670	€ 8,55	158
MPVR94633	0006	€ 1,02	188	MPVR94748	0004	€ 2,35	195	MPVR94842	0099	€ 11,00	136
MPVR94638	0006	€ 0,51	133	MPVR94749	0006	€ 1,02	134	MPVR94842	0008	€ 16,45	157
MPVR94644	0006	€ 0,72	133	MPVR94749	0006	€ 1,02	181	MPVR94843	0099	€ 11,00	136
MPVR94645	0015	€ 6,40	133	MPVR94752	0006	€ 0,82	134	MPVR94843	0008	€ 16,45	157
MPVR94646	0010	€ 4,70	108	MPVR94752	0006	€ 0,82	166	MPVR94844	0008	€ 19,80	157
MPVR94646	0009	€ 4,70	108	MPVR94752	0006	€ 0,82	168	MPVR94847	0599	€ 7,85	137
MPVR94646	0004	€ 4,70	108	MPVR94752	0006	€ 0,82	170	MPVR94847	0299	€ 7,85	137
MPVR94646	0015	€ 4,70	108	MPVR94752	0006	€ 0,82	171	MPVR94847	0499	€ 7,85	137
MPVR94646	0010	€ 4,70	108	MPVR94752	0006	€ 0,82	172	MPVR94847	0999	€ 7,85	137
MPVR94646	0009	€ 4,70	108	MPVR94752	0006	€ 0,82	173	MPVR94847	0506	€ 12,00	159
MPVR94646	0004	€ 4,70	108	MPVR94752	0006	€ 0,82	181	MPVR94847	0206	€ 12,00	159
MPVR94646	0015	€ 4,70	111	MPVR94772	0006	€ 1,32	203	MPVR94847	0906	€ 12,00	159
MPVR94646	0010	€ 4,70	111	MPVR94773	0099	€ 6,00	134	MPVR94847	0406	€ 12,00	159
MPVR94646	0009	€ 4,70	111	MPVR94773	0006	€ 7,45	166	MPVR94848	0599	€ 14,95	138
MPVR94646	0004	€ 4,70	111	MPVR94773	0006	€ 7,45	167	MPVR94848	0299	€ 14,95	138
MPVR94646	0015	€ 4,70	111	MPVR94773	0006	€ 7,45	168	MPVR94848	0499	€ 14,95	138
MPVR94646	0009	€ 4,70	111	MPVR94773	0006	€ 7,45	169	MPVR94848	0999	€ 14,95	138
MPVR94646	0004	€ 4,70	111	MPVR94773	0006	€ 7,45	170	MPVR94848	0506	€ 19,00	159
MPVR94647	0006	€ 0,51	133	MPVR94773	0006	€ 7,45	173	MPVR94848	0206	€ 19,00	159
MPVR94664	0006	€ 6,80	98	MPVR94774	0006	€ 9,25	166	MPVR94848	0906	€ 19,00	159
MPVR94664	0006	€ 6,80	98	MPVR94774	0006	€ 9,25	168	MPVR94849	0099	€ 24,90	136
MPVR94664	0006	€ 6,80	184	MPVR94774	0006	€ 9,25	170	MPVR94849	0008	€ 33,40	157
MPVR94664	0006	€ 6,80	189	MPVR94774	0006	€ 9,25	171	MPVR94850	0099	€ 17,00	136
MPVR94671	0006	€ 18,80	86	MPVR94774	0006	€ 9,25	172	MPVR94850	0008	€ 21,95	157
MPVR94671	0001	€ 18,80	86	MPVR94774	0006	€ 9,25	173	MPVR94851	0099	€ 4,60	137
MPVR94671	0015	€ 18,80	86	MPVR94778	0006	€ 3,35	109	MPVR94851	0008	€ 6,30	158
MPVR94675	0006	€ 2,45	86	MPVR94778	0006	€ 3,35	111	MPVR94854	0013	€ 15,50	141
MPVR94675	0015	€ 2,45	86	MPVR94778	0006	€ 3,35	109	MPVR94854	0008	€ 15,50	162
MPVR94675	0001	€ 2,45	86	MPVR94778	0006	€ 3,35	112	MPVR94855	0013	€ 1,83	136
				MPVR94778	0006	€ 3,35	112	MPVR94855	0006	€ 2,03	156

CODE INDEX

CODE	DIGIT	UNIT PRICE	PAGE	CODE	DIGIT	UNIT PRICE	PAGE	CODE	DIGIT	UNIT PRICE	PAGE
MPVR94856	0099	€ 0,51	137	PANN00039	0005	€ 0,31	80	PMLA96078	0006	€ 25,40	181
MPVR94856	0008	€ 0,61	158	PANN00039	0011	€ 0,31	80	PMLA96079	0006	€ 21,95	174
MPVR94857	0099	€ 0,51	137	PANN00039	0003	€ 0,31	80	PMLA96079	0006	€ 21,95	181
MPVR94857	0008	€ 0,61	158	PANN00039	0004	€ 0,31	80	PMLA96081	0006	€ 18,70	167
MPVR94858	0099	€ 0,51	136	PANN00042	0005	€ 0,66	80	PMLA96081	0006	€ 18,70	169
MPVR94858	0008	€ 0,61	157	PANN00042	0002	€ 0,66	80	PMLA96081	0006	€ 18,70	175
MPVR94859	0006	€ 3,90	157	PANN00042	0003	€ 0,66	80	PMLA96081	0006	€ 18,70	181
MPVR94859	0008	€ 3,90	157	PANN00042	0004	€ 0,66	80	PMLA96082	0006	€ 16,45	134
MPVR94860	0006	€ 3,90	157	PANN00044	0005	€ 2,45	80	PMLA96082	0006	€ 16,45	167
MPVR94860	0008	€ 3,90	157	PANN00044	0011	€ 2,45	80	PMLA96082	0006	€ 16,45	168
MPVR94861	0013	€ 1,02	136	PANN00044	0003	€ 2,45	80	PMLA96082	0006	€ 16,45	170
MPVR94861	0008	€ 1,43	157	PANN00044	0004	€ 2,45	80	PMLA96082	0006	€ 16,45	171
MPVR94866	0099	€ 2,03	139	PANN00045	0015	€ 4,10	79	PMLA96082	0006	€ 16,45	172
MPVR94866	0008	€ 2,03	160	PANN00045	0040	€ 4,10	79	PMLA96082	0006	€ 16,45	174
MPVR94870	0099	€ 1,02	136	PANN00047	0015	€ 2,95	80	PMLA96082	0006	€ 16,45	181
MPVR94870	0099	€ 1,02	138	PANN00055	0005	€ 2,15	81	PMLA96084	0006	€ 6,50	184
MPVR94870	0008	€ 2,03	160	PANN00055	0002	€ 2,15	81	PMLA96085	0006	€ 16,25	181
MPVR94871	0099	€ 0,41	136	PANN00055	0003	€ 2,15	81	PMLA96086	0006	€ 19,90	172
MPVR94871	0008	€ 0,41	156	PANN00055	0004	€ 2,15	81	PMLA96086	0006	€ 19,90	173
MPVR94873	0099	€ 0,56	137	PANN00057		€ 1,22	80	PMLA96086	0006	€ 19,90	181
MPVR94873	0008	€ 0,66	158	PANN00064		€ 0,50	29	PMLA96087		€ 13,80	107
MPVR94879	0099	€ 5,20	138	PANN00065		€ 0,13	29	PMLA96087		€ 13,80	107
MPVR94879	0008	€ 6,30	160	PANN00067		€ 0,04	28	PMLA96087		€ 13,80	108
MPVR94891	0005	€ 1,53	138	PANN00070	0005	€ 2,15	79	PMLA96087		€ 13,80	108
MPVR94891	0002	€ 1,53	138	PANN00070	0002	€ 2,15	79	PMLA96088		€ 15,45	109
MPVR94891	0004	€ 1,53	138	PANN00070	0003	€ 2,15	79	PMLA96088		€ 15,45	109
MPVR94891	0009	€ 1,53	138	PANN00070	0004	€ 2,15	79	PMLA96088		€ 15,45	110
MPVR94891	0005	€ 1,53	159	PANN00073		€ 13,30	28	PMLA96088		€ 15,45	110
MPVR94891	0002	€ 1,53	159	PANN00073		€ 13,30	216	PMLA96088		€ 15,45	111
MPVR94891	0009	€ 1,53	159	PANN00075		€ 0,61	80	PMLA96088		€ 15,45	112
MPVR94891	0004	€ 1,53	159	PANN00118	0005	€ 3,35	79	PMLA96088		€ 15,45	112
MPVR94920	0099	€ 1,58	137	PANN00118	0002	€ 3,35	79	PMLA96088		€ 15,45	133
MPVR94920	0008	€ 1,70	158	PANN00118	0003	€ 3,35	79	PMLA96090		€ 52,80	113
MPVR94924	0009	€ 2,03	212	PANN00118	0004	€ 3,35	79	PMLA96090		€ 52,80	113
MPVR94925	IP06	€ 19,10	63	PANN00124	IP15	€ 5,00	28	PMLA96090		€ 52,80	114
MPVR94925	IP06	€ 19,10	238	PANN00124	IP02	€ 5,00	28	PMLA96093	0008	€ 15,45	141
MPVR99754		€ 2,30	192	PANN00127		€ 5,90	28	PMLA96093	0008	€ 15,45	163
MPVR99755		€ 5,50	192	PANN00129		€ 9,10	28	PMLA96095	0081	€ 10,50	142
MPVR99758		€ 5,50	175	PANN00130		€ 4,00	28	PMLA96095	0081	€ 10,50	164
MPVR99799	0005	€ 5,00	88	PANN00135		€ 5,00	28	PMLA96096	0006	€ 18,70	166
MPVR99846		€ 18,80	133	PANN00137		€ 6,30	28	PMLA96096	0006	€ 18,70	168
PANN00003		€ 0,07	28	PANN00140		€ 10,00	32	PMLA96096	0006	€ 18,70	171
PANN00004		€ 0,10	28	PANN80004		€ 1,26	28	PMLA96096	0006	€ 18,70	181
PANN00005		€ 0,35	28	PATT00002	0006	€ 11,10	25	PMLA96096	0006	€ 18,70	203
PANN00008		€ 0,09	28	PATT00004	0006	€ 11,80	25	PMVR01538	0099	€ 8,75	136
PANN00010		€ 0,05	28	PATT00008	0006	€ 16,40	25	PMVR01538	0006	€ 8,75	157
PANN00011		€ 0,08	28	PATT00010		€ 26,90	25	PMVR01539	0099	€ 32,80	138
PANN00012	0004	€ 2,15	80	PATT00015	0006	€ 16,55	25	PMVR01539	0008	€ 38,30	160
PANN00016		€ 0,10	28	PML A95978		€ 21,95	88	PMVR01545	0006	€ 6,50	139
PANN00019	0003	€ 4,60	79	PML A96035		€ 25,10	88	PMVR01545	0008	€ 6,50	161
PANN00022	0005	€ 1,32	79	PMLA00257		€ 8,45	20	PMVR01547	0699	€ 32,80	138
PANN00022	0002	€ 1,32	79	PMLA95924		€ 26,40	20	PMVR01547	0599	€ 32,80	138
PANN00022	0003	€ 1,32	79	PMLA95978		€ 21,95	88	PMVR01547	0299	€ 32,80	138
PANN00022	0004	€ 1,32	79	PMLA95998		€ 28,55	113	PMVR01547	0999	€ 32,80	138
PANN00023	0005	€ 2,65	79	PMLA95998		€ 28,55	113	PMVR01547	0499	€ 32,80	138
PANN00023	0002	€ 2,65	79	PMLA95998		€ 28,55	114	PMVR01547	0099	€ 32,80	138
PANN00023	0003	€ 2,65	79	PMLA96003		€ 26,40	97	PMVR01547	0608	€ 44,70	159
PANN00023	0004	€ 2,65	79	PMLA96014		€ 23,65	89	PMVR01547	0508	€ 44,70	159
PANN00025	0055	€ 3,55	79	PMLA96016		€ 9,25	203	PMVR01547	0208	€ 44,70	159
PANN00025	0052	€ 3,55	79	PMLA96026		€ 21,95	97	PMVR01547	0908	€ 44,70	159
PANN00025	0053	€ 3,55	79	PMLA96030		€ 31,00	89	PMVR01547	0408	€ 44,70	159
PANN00025	0054	€ 3,55	79	PMLA96034		€ 20,90	87	PMVR06290	0099	€ 25,20	139
PANN00026	0005	€ 3,60	79	PMLA96035		€ 25,50	87	PMVR06290	0008	€ 35,20	160
PANN00026	0011	€ 3,60	79	PMLA96036		€ 19,90	87	PMVR06324	0699	€ 25,00	138
PANN00026	0003	€ 3,60	79	PMLA96039		€ 9,35	89	PMVR06324	0599	€ 25,00	138
PANN00026	0004	€ 3,60	79	PMLA96078	0006	€ 25,40	174	PMVR06324	0299	€ 25,00	138

CODE INDEX

CODE	DIGIT	UNIT PRICE	PAGE	CODE	DIGIT	UNIT PRICE	PAGE	CODE	DIGIT	UNIT PRICE	PAGE
PMVR06324	0999	€ 25,00	138	PMVR95608	0015	€ 41,80	107	PMVR95609	0010	€ 8,75	111
PMVR06324	0499	€ 25,00	138	PMVR95608	0010	€ 41,80	107	PMVR95609	0009	€ 8,75	111
PMVR06324	0099	€ 25,00	138	PMVR95608	0009	€ 41,80	107	PMVR95609	0004	€ 8,75	111
PMVR06324	0608	€ 36,75	159	PMVR95608	0004	€ 41,80	107	PMVR95609	0015	€ 8,75	112
PMVR06324	0508	€ 36,75	159	PMVR95608	0015	€ 41,80	107	PMVR95609	0010	€ 8,75	112
PMVR06324	0208	€ 36,75	159	PMVR95608	0010	€ 41,80	107	PMVR95609	0009	€ 8,75	112
PMVR06324	0908	€ 36,75	159	PMVR95608	0009	€ 41,80	107	PMVR95609	0004	€ 8,75	112
PMVR06324	0408	€ 36,75	159	PMVR95608	0004	€ 41,80	107	PMVR95609	0015	€ 8,75	112
PMVR06334	0001	€ 11,30	61	PMVR95608	0015	€ 41,80	109	PMVR95609	0010	€ 8,75	112
PMVR06377		€ 96,90	140	PMVR95608	0010	€ 41,80	109	PMVR95609	0009	€ 8,75	112
PMVR06377		€ 96,90	162	PMVR95608	0009	€ 41,80	109	PMVR95609	0004	€ 8,75	112
PMVR06378		€ 102,30	140	PMVR95608	0004	€ 41,80	109	PMVR95609	0006	€ 8,75	133
PMVR06378		€ 102,30	162	PMVR95608	0015	€ 41,80	109	PMVR95610	0006	€ 16,15	111
PMVR06379	0006	€ 117,60	182	PMVR95608	0010	€ 41,80	109	PMVR95610	0006	€ 16,15	112
PMVR06420	0008	€ 31,70	163	PMVR95608	0009	€ 41,80	109	PMVR95610	0006	€ 16,15	112
PMVR06423	0008	€ 29,65	142	PMVR95608	0004	€ 41,80	109	PMVR95616	0006	€ 42,40	186
PMVR06423	0008	€ 29,65	163	PMVR95608	0015	€ 41,80	110	PMVR95622	0006	€ 21,95	86
PMVR06430		€ 14,55	222	PMVR95608	0010	€ 41,80	110	PMVR95622	0015	€ 21,95	86
PMVR06435	0013	€ 14,85	139	PMVR95608	0009	€ 41,80	110	PMVR95622	0001	€ 21,95	86
PMVR06435	0008	€ 14,85	161	PMVR95608	0004	€ 41,80	110	PMVR95623	0006	€ 42,75	86
PMVR06443	0006	€ 7,75	139	PMVR95608	0015	€ 41,80	110	PMVR95623	0015	€ 42,75	86
PMVR06443	0008	€ 7,75	161	PMVR95608	0010	€ 41,80	110	PMVR95623	0001	€ 42,75	86
PMVR06449	0099	€ 13,90	134	PMVR95608	0009	€ 41,80	110	PMVR95624	0006	€ 40,70	86
PMVR06490	0013	€ 14,35	138	PMVR95608	0004	€ 41,80	110	PMVR95624	0015	€ 40,70	86
PMVR06490	0008	€ 14,35	160	PMVR95608	0015	€ 41,80	111	PMVR95624	0001	€ 40,70	86
PMVR06633	0013	€ 6,50	139	PMVR95608	0010	€ 41,80	111	PMVR95631	0015	€ 5,00	88
PMVR06633	0013	€ 6,50	161	PMVR95608	0009	€ 41,80	111	PMVR95633	0015	€ 5,00	88
PMVR06722	0013	€ 13,30	139	PMVR95608	0004	€ 41,80	111	PMVR95637	0006	€ 1,12	139
PMVR06722	0013	€ 13,30	160	PMVR95608	0015	€ 41,80	112	PMVR95637	0008	€ 1,12	161
PMVR06724	0013	€ 7,00	139	PMVR95608	0010	€ 41,80	112	PMVR95637	0006	€ 1,12	179
PMVR06724	0013	€ 7,00	160	PMVR95608	0009	€ 41,80	112	PMVR95637	0006	€ 1,12	183
PMVR06751	0006	€ 5,50	138	PMVR95608	0004	€ 41,80	112	PMVR95637	0006	€ 1,12	190
PMVR06751	0006	€ 5,50	160	PMVR95608	0015	€ 41,80	112	PMVR95638	0006	€ 1,63	139
PMVR06812	0081	€ 27,00	142	PMVR95608	0010	€ 41,80	112	PMVR95638	0008	€ 1,63	161
PMVR06812	0081	€ 27,00	164	PMVR95608	0009	€ 41,80	112	PMVR95639	0006	€ 1,63	139
PMVR95576	0006	€ 107,20	177	PMVR95608	0004	€ 41,80	112	PMVR95639	0008	€ 1,63	161
PMVR95576	0006	€ 107,20	178	PMVR95608	0015	€ 41,80	113	PMVR95640	0006	€ 3,70	134
PMVR95576	0006	€ 107,20	179	PMVR95608	0010	€ 41,80	113	PMVR95640	0006	€ 3,70	166
PMVR95576	0006	€ 107,20	186	PMVR95608	0009	€ 41,80	113	PMVR95640	0006	€ 3,70	167
PMVR95583	0006	€ 41,30	177	PMVR95608	0004	€ 41,80	113	PMVR95640	0006	€ 3,70	168
PMVR95583	0006	€ 41,30	179	PMVR95608	0015	€ 41,80	113	PMVR95640	0006	€ 3,70	169
PMVR95583	0006	€ 41,30	186	PMVR95608	0010	€ 41,80	113	PMVR95640	0006	€ 3,70	170
PMVR95589	0006	€ 37,40	173	PMVR95608	0009	€ 41,80	113	PMVR95640	0006	€ 3,70	171
PMVR95589	0006	€ 37,40	179	PMVR95608	0004	€ 41,80	113	PMVR95640	0006	€ 3,70	172
PMVR95589	0006	€ 37,40	188	PMVR95608	0015	€ 41,80	114	PMVR95640	0006	€ 3,70	173
PMVR95595	0006	€ 113,90	203	PMVR95608	0010	€ 41,80	114	PMVR95640	0006	€ 3,70	174
PMVR95604	0099	€ 11,85	134	PMVR95608	0009	€ 41,80	114	PMVR95640	0006	€ 3,70	175
PMVR95604	0006	€ 13,05	182	PMVR95608	0004	€ 41,80	114	PMVR95640	0006	€ 3,70	183
PMVR95604	0006	€ 13,05	188	PMVR95608	0099	€ 35,65	133	PMVR95641	0006	€ 4,30	183
PMVR95605	0006	€ 47,20	189	PMVR95609	0015	€ 8,75	109	PMVR95642	0006	€ 5,40	183
PMVR95607	0015	€ 38,40	108	PMVR95609	0010	€ 8,75	109	PMVR95644	0006	€ 5,00	190
PMVR95607	0010	€ 38,40	108	PMVR95609	0009	€ 8,75	109	PMVR95645	0006	€ 5,30	190
PMVR95607	0009	€ 38,40	108	PMVR95609	0004	€ 8,75	109	PMVR95648		€ 4,90	198
PMVR95607	0004	€ 38,40	108	PMVR95609	0015	€ 8,75	109	PMVR95651	0006	€ 12,60	111
PMVR95607	0015	€ 38,40	108	PMVR95609	0010	€ 8,75	109	PMVR95651	0006	€ 12,60	112
PMVR95607	0010	€ 38,40	108	PMVR95609	0009	€ 8,75	109	PMVR95651	0006	€ 12,60	112
PMVR95607	0009	€ 38,40	108	PMVR95609	0004	€ 8,75	109	PMVR95653	0006	€ 8,05	181
PMVR95607	0004	€ 38,40	108	PMVR95609	0015	€ 8,75	110	PMVR95654	0006	€ 9,55	181
PMVR95607	0015	€ 38,40	111	PMVR95609	0010	€ 8,75	110	PMVR95658	0006	€ 49,50	188
PMVR95607	0010	€ 38,40	111	PMVR95609	0009	€ 8,75	110	PMVR95667	0005	€ 2,15	225
PMVR95607	0009	€ 38,40	111	PMVR95609	0004	€ 8,75	110	PMVR95667	0002	€ 2,15	225
PMVR95607	0004	€ 38,40	111	PMVR95609	0015	€ 8,75	110	PMVR95667	0009	€ 2,15	225
PMVR95607	0015	€ 38,40	111	PMVR95609	0010	€ 8,75	110	PMVR95667	0004	€ 2,15	225
PMVR95607	0010	€ 38,40	111	PMVR95609	0009	€ 8,75	110	PMVR95667	0005	€ 2,15	237
PMVR95607	0009	€ 38,40	111	PMVR95609	0004	€ 8,75	110	PMVR95667	0002	€ 2,15	237
PMVR95607	0004	€ 38,40	111	PMVR95609	0015	€ 8,75	111	PMVR95667	0009	€ 2,15	237

CODE INDEX

CODE	DIGIT	UNIT PRICE	PAGE	CODE	DIGIT	UNIT PRICE	PAGE	CODE	DIGIT	UNIT PRICE	PAGE
PMVR95667	0004	€ 2,15	237	PMVR95769	0006	€ 27,20	178	PRAL00119	0008	€ 9,10	140
PMVR95671	0099	€ 116,00	135	PMVR95769	0006	€ 27,20	188	PRAL00119	0008	€ 9,10	162
PMVR95671	0008	€ 128,50	156	PMVR95770	0006	€ 57,70	186	PRTE00001	0003	€ 8,25	238
PMVR95672	0099	€ 74,00	135	PMVR95772	0006	€ 38,40	186	PRTE00002	0003	€ 9,05	238
PMVR95672	0008	€ 80,30	156	PMVR95776	0006	€ 17,50	174	PRTE00004	0003	€ 17,50	238
PMVR95674	0099	€ 109,30	135	PMVR95776	0006	€ 17,50	180	PRTE00005	0003	€ 19,80	238
PMVR95674	0008	€ 121,90	156	PMVR95777	0006	€ 34,40	188	PRTE00006	0003	€ 22,95	238
PMVR95675	0099	€ 80,70	135	PMVR95781	0006	€ 5,00	177	PRTE00007	0003	€ 15,75	238
PMVR95675	0008	€ 86,90	156	PMVR95781	0006	€ 5,00	178	PRTE00008	0003	€ 8,85	238
PMVR95676	0099	€ 228,30	135	PMVR95784	0006	€ 5,00	177	PRTE00010	0003	€ 24,30	238
PMVR95676	0008	€ 240,80	156	PMVR95784	0006	€ 5,00	178	PRTE00011	0003	€ 29,15	238
PMVR95678	0099	€ 113,80	135	PMVR95784	0006	€ 5,00	190	PRTE00012	0003	€ 31,40	238
PMVR95678	0008	€ 125,30	156	PMVR95785	0009	€ 32,90	179	PRTE00013	0003	€ 20,40	238
PMVR95680	0008	€ 31,80	160	PMVR95785	0009	€ 32,90	191	PRTE00014	0003	€ 23,65	238
PMVR95681	0099	€ 38,00	138	PMVR95786	0009	€ 50,65	179	PRTE00015	0003	€ 26,90	238
PMVR95681	0008	€ 44,70	160	PMVR95786	0009	€ 50,65	191	PRTE00016	0003	€ 29,15	238
PMVR95682	0099	€ 19,80	138	PMVR95803	0006	€ 5,00	190	PRTE00017	0003	€ 30,80	238
PMVR95682	0008	€ 25,30	160	PMVR95804	0006	€ 5,10	190	PRTE00018	0003	€ 37,90	238
PMVR95683	0008	€ 31,60	160	PMVR95806		€ 7,35	183	PRTE00019	0003	€ 48,90	238
PMVR95684	0099	€ 21,85	139	PMVR95821	0006	€ 46,20	188	PRTE00020	0003	€ 76,90	238
PMVR95684	0008	€ 31,80	160	PMVR95823	0015	€ 1,83	237	PRTE00022	0003	€ 7,25	238
PMVR95685	0699	€ 24,90	138	PMVR95823	0002	€ 1,83	237	PRTE00045	0009	€ 14,85	238
PMVR95685	0599	€ 24,90	138	PMVR95823	0009	€ 1,83	237	PRTE80154		€ 81,70	230
PMVR95685	0299	€ 24,90	138	PMVR95823	0004	€ 1,83	237	PRTE80155		€ 102,00	230
PMVR95685	0999	€ 24,90	138	POCA00001		€ 47,20	88	PRTE80156		€ 122,70	230
PMVR95685	0499	€ 24,90	138	POCA00002		€ 34,70	249	PRTE80157		€ 144,40	230
PMVR95685	0099	€ 24,90	138	POCA00003		€ 48,40	249	RACC00001	0003	€ 3,35	238
PMVR95685	0608	€ 36,65	159	POCA00004		€ 45,20	88	RACC00002	0003	€ 8,85	238
PMVR95685	0508	€ 36,65	159	POCA00005	0001	€ 18,30	249	RACC00003		€ 7,50	232
PMVR95685	0208	€ 36,65	159	POCA00006	0006	€ 18,00	113	RACC00004	0003	€ 6,80	29
PMVR95685	0908	€ 36,65	159	POCA00006	0006	€ 18,00	113	RACC70033		€ 18,40	230
PMVR95685	0408	€ 36,65	159	POCA00006	0006	€ 18,00	114	RASC00002		€ 9,95	240
PMVR95687	0013	€ 13,10	138	POCA00006	0006	€ 18,00	185	RASC00003		€ 10,80	240
PMVR95687	0008	€ 13,10	160	POCA00006	0006	€ 18,00	191	RASC00004		€ 15,95	240
PMVR95688	0006	€ 7,45	142	POCA00007	0001	€ 50,05	249	RASC00009	IP09	€ 3,05	239
PMVR95688	0008	€ 7,45	163	PORT00002	0005	€ 48,30	88	RASC70016	31ST	€ 5,90	239
PMVR95743	0006	€ 80,60	166	PORT00009		€ 34,50	225	RASC70017		€ 2,14	228
PMVR95743	0006	€ 80,60	167	PORT00009		€ 34,50	225	RASC70017	07ST	€ 2,14	239
PMVR95743	0006	€ 80,60	168	PORT00010		€ 103,30	225	RASC70018	42ST	€ 0,31	239
PMVR95743	0006	€ 80,60	169	PORT00011		€ 130,10	225	RASC70025	02ST	€ 5,70	239
PMVR95743	0006	€ 80,60	170	PORT80001		€ 15,30	230	RASC70026	42ST	€ 4,20	239
PMVR95743	0006	€ 80,60	171	PORT80002		€ 18,40	230	RASC80042		€ 11,50	231
PMVR95743	0006	€ 80,60	175	PRAL00026	0006	€ 31,90	187	RTRT00557		€ 9,85	135
PMVR95743	0006	€ 80,60	180	PRAL00027	0006	€ 31,90	177	RTRT00557		€ 9,85	156
PMVR95747	0006	€ 107,70	180	PRAL00027	0006	€ 31,90	187	RTRT00561		€ 32,30	187
PMVR95750	0006	€ 68,10	172	PRAL00028	0006	€ 32,90	178	RTRT00563	0606	€ 8,05	86
PMVR95750	0006	€ 68,10	173	PRAL00028	0006	€ 32,90	187	RTRT00563	0606	€ 8,05	89
PMVR95750	0006	€ 68,10	174	PRAL00033	0006	€ 17,50	86	RTRT00563	0606	€ 8,05	176
PMVR95750	0006	€ 68,10	180	PRAL00033	0015	€ 17,50	86	RTRT00563	0606	€ 8,05	180
PMVR95752	0006	€ 21,20	166	PRAL00033	0001	€ 17,50	86	RTRT00564	0606	€ 6,50	84
PMVR95752	0006	€ 21,20	167	PRAL00035	0006	€ 31,90	177	RTRT00564	0606	€ 6,50	88
PMVR95752	0006	€ 21,20	168	PRAL00035	0006	€ 31,90	187	RTRT00566	0006	€ 6,50	86
PMVR95752	0006	€ 21,20	169	PRAL00042	0006	€ 36,35	179	RTRT00566	0015	€ 6,50	86
PMVR95752	0006	€ 21,20	170	PRAL00042	0006	€ 36,35	188	RTRT00566	0001	€ 6,50	86
PMVR95752	0006	€ 21,20	171	PRAL00043	0006	€ 36,35	179	RTRT00566	0006	€ 6,50	132
PMVR95752	0006	€ 21,20	172	PRAL00043	0006	€ 36,35	188	RTRT00566	0006	€ 6,50	180
PMVR95752	0006	€ 21,20	174	PRAL00076	0006	€ 11,60	86	RTRT00671		€ 29,65	135
PMVR95752	0006	€ 21,20	182	PRAL00076	0015	€ 11,60	86	RTRT00687		€ 21,75	135
PMVR95753	0006	€ 23,25	175	PRAL00076	0001	€ 11,60	86	RTRT00687		€ 21,75	156
PMVR95753	0006	€ 23,25	182	PRAL00081	0008	€ 9,20	136	RTRT00688		€ 26,20	135
PMVR95754	0006	€ 54,90	182	PRAL00081	0008	€ 9,20	157	RTRT00688		€ 26,20	156
PMVR95756		€ 8,85	134	PRAL00082	0008	€ 10,50	157	RTRT00725		€ 9,85	134
PMVR95756		€ 8,85	184	PRAL00083	0008	€ 7,60	157	RTRT00725		€ 9,85	180
PMVR95758	0006	€ 49,50	182	PRAL00114	0008	€ 16,15	135	RTRT00725		€ 9,85	187
PMVR95761	0006	€ 24,40	185	PRAL00115		€ 1,83	135	RTRT00754		€ 17,50	187
PMVR95769	0006	€ 27,20	177	PRAL00116		€ 1,83	135	RTRT00755		€ 20,90	187

CODE INDEX

CODE	DIGIT	UNIT PRICE	PAGE	CODE	DIGIT	UNIT PRICE	PAGE	CODE	DIGIT	UNIT PRICE	PAGE
RTRT00756		€ 17,50	135	SACC00021	0004	€ 38,40	84	SCOP00063		€ 13,10	24
RTRT00756		€ 17,50	156	SACC00021	0005	€ 38,40	105	SCOP00064		€ 4,80	25
RTRT00757		€ 20,90	135	SACC00021	0002	€ 38,40	105	SCOP00064		€ 4,80	25
RTRT00757		€ 20,90	156	SACC00021	0003	€ 38,40	105	SCOP00127		€ 14,45	24
RTRT00758		€ 17,50	187	SACC00021	0004	€ 38,40	105	SCOP00129	0005	€ 34,50	24
RTRT00759		€ 17,50	180	SACC00024	0006	€ 43,05	139	SCOV00001		€ 5,20	29
RTRT00760		€ 20,90	180	SACC00024	0006	€ 43,05	161	SCOV00003		€ 20,80	29
RTRT00761		€ 15,25	187	SACC00027	0001	€ 11,80	57	SCOV00004		€ 9,05	29
RTRT00762		€ 15,25	187	SACC00034	0006	€ 47,40	86	SCOV00005		€ 5,70	240
RTRT00763		€ 15,25	180	SACC00034	0006	€ 47,40	105	SCOV00006		€ 5,00	240
RTRT00784		€ 32,30	135	SACC00034	0006	€ 47,40	106	SCOV00012		€ 4,30	240
RTRT00784		€ 32,30	156	SACC00034	0006	€ 47,40	134	SECC00001	0015	€ 57,15	98
RTRT99629		€ 13,10	135	SACC00034	0005	€ 47,40	183	SECC00001	0002	€ 57,15	98
RTRT99629		€ 13,10	156	SACC00034	0002	€ 47,40	183	SECC00001	0009	€ 57,15	98
RTRT99645		€ 13,10	180	SACC00034	0003	€ 47,40	183	SECC00001	0004	€ 57,15	98
RTRT99645		€ 13,10	187	SACC00034	0004	€ 47,40	183	SECC00003	0015	€ 49,60	98
RTRT99650		€ 11,00	187	SACC00034	0006	€ 47,40	183	SECC00003	0002	€ 49,60	98
RTRT99663		€ 6,50	132	SACC00034	0006	€ 47,40	191	SECC00003	0009	€ 49,60	98
RTRT99663		€ 6,50	133	SACC00036	0005	€ 34,50	161	SECC00003	0004	€ 49,60	98
RTRT99663		€ 6,50	135	SACC00036	0002	€ 34,50	161	SECC00007	0015	€ 59,10	98
SACC00001	0001	€ 8,35	57	SACC00036	0005	€ 34,50	175	SECC00007	0002	€ 59,10	98
SACC00001	0001	€ 8,35	140	SACC00036	0002	€ 34,50	175	SECC00007	0009	€ 59,10	98
SACC00001	0001	€ 8,35	161	SACC00036	0005	€ 34,50	183	SECC00007	0004	€ 59,10	98
SACC00002	0501	€ 11,80	57	SACC00036	0002	€ 34,50	183	SECC00008	0015	€ 40,20	98
SACC00002	0201	€ 11,80	57	SACC00036	0005	€ 34,50	183	SECC00008	0002	€ 40,20	98
SACC00002	0501	€ 11,80	140	SACC00036	0002	€ 34,50	183	SECC00008	0009	€ 40,20	98
SACC00002	0201	€ 11,80	140	SACC00036	0005	€ 34,50	191	SECC00008	0004	€ 40,20	98
SACC00002	0501	€ 11,80	161	SACC00036	0002	€ 34,50	191	SECC00009	IP15	€ 84,55	99
SACC00002	0201	€ 11,80	161	SACC00038	0025	€ 31,90	140	SECC00009	IP02	€ 84,55	99
SACC00005	0006	€ 72,20	203	SACC00038	0002	€ 31,90	140	SECC00009	IP09	€ 84,55	99
SACC00008	0005	€ 44,70	183	SACC00038	0025	€ 31,90	161	SECC00009	IP04	€ 84,55	99
SACC00008	0002	€ 44,70	183	SACC00038	0002	€ 31,90	161	SECC00015	1506	€ 8,85	190
SACC00008	0005	€ 44,70	191	SACC00038	0025	€ 31,90	191	SECC00015	0206	€ 8,85	190
SACC00008	0002	€ 44,70	191	SACC00038	0002	€ 31,90	191	SECC00015	0906	€ 8,85	190
SACC00009	1501	€ 8,35	57	SACC00046	0005	€ 42,85	88	SECC00015	0406	€ 8,85	190
SACC00009	0201	€ 8,35	57	SACC00059	0005	€ 26,90	140	SECC00016	0005	€ 18,30	237
SACC00009	0301	€ 8,35	57	SACC00059	0002	€ 26,90	140	SECC00016	0002	€ 18,30	237
SACC00009	0401	€ 8,35	57	SACC00059	0005	€ 26,90	161	SECC00016	0003	€ 18,30	237
SACC00009	1501	€ 8,35	140	SACC00059	0002	€ 26,90	161	SECC00017	0015	€ 10,30	60
SACC00009	0201	€ 8,35	140	SACC00061	0005	€ 32,00	140	SECC00017	0002	€ 10,30	60
SACC00009	0301	€ 8,35	140	SACC00061	0002	€ 32,00	140	SECC00017	0009	€ 10,30	60
SACC00009	0401	€ 8,35	140	SACC00061	0003	€ 32,00	140	SECC00017	0004	€ 10,30	60
SACC00009	1501	€ 8,35	161	SACC00061	0004	€ 32,00	140	SECC00017	0099	€ 9,05	60
SACC00009	0201	€ 8,35	161	SACC00061	0005	€ 32,00	161	SECC00020	0015	€ 16,45	60
SACC00009	0301	€ 8,35	161	SACC00061	0002	€ 32,00	161	SECC00020	0002	€ 16,45	60
SACC00009	0401	€ 8,35	161	SACC00061	0003	€ 32,00	161	SECC00020	0009	€ 16,45	60
SACC00012	0005	€ 31,80	111	SACC00061	0004	€ 32,00	161	SECC00020	0004	€ 16,45	60
SACC00012	0002	€ 31,80	111	SACC00061	0005	€ 32,00	183	SECC00020	0099	€ 14,45	60
SACC00012	0009	€ 31,80	111	SACC00061	0002	€ 32,00	183	SECC00027	IP15	€ 112,10	97
SACC00012	0004	€ 31,80	111	SACC00061	0003	€ 32,00	183	SECC00027	IP02	€ 112,10	97
SACC00012	0005	€ 31,80	112	SACC00061	0004	€ 32,00	183	SECC00027	IP09	€ 112,10	97
SACC00012	0002	€ 31,80	112	SACC00062	0002	€ 34,50	225	SECC00027	IP04	€ 112,10	97
SACC00012	0009	€ 31,80	112	SCOP00001		€ 17,30	20	SECC00032	0015	€ 58,20	97
SACC00012	0004	€ 31,80	112	SCOP00002		€ 20,30	20	SECC00032	0002	€ 58,20	97
SACC00012	0005	€ 31,80	112	SCOP00003		€ 21,75	20	SECC00032	0009	€ 58,20	97
SACC00012	0002	€ 31,80	112	SCOP00004		€ 26,40	20	SECC00032	0004	€ 58,20	97
SACC00012	0009	€ 31,80	112	SCOP00040		€ 10,80	24	SECC00033	0015	€ 96,90	97
SACC00012	0004	€ 31,80	112	SCOP00041		€ 14,45	24	SECC00033	0002	€ 96,90	97
SACC00013	0004	€ 33,50	113	SCOP00042		€ 20,30	24	SECC00033	0009	€ 96,90	97
SACC00013	0004	€ 33,50	113	SCOP00044		€ 16,45	24	SECC00033	0004	€ 96,90	97
SACC00013	0004	€ 33,50	114	SCOP00045		€ 18,30	24	SECC00034	IP15	€ 102,30	97
SACC00017	0201	€ 9,75	140	SCOP00046		€ 23,65	24	SECC00034	IP02	€ 102,30	97
SACC00017	0201	€ 9,75	162	SCOP00058		€ 77,50	20	SECC00034	IP09	€ 102,30	97
SACC00021	0005	€ 38,40	84	SCOP00059		€ 81,30	20	SECC00034	IP04	€ 102,30	97
SACC00021	0002	€ 38,40	84	SCOP00061		€ 84,00	20	SECC00035	IP15	€ 112,10	98
SACC00021	0003	€ 38,40	84	SCOP00062		€ 87,30	20	SECC00035	IP02	€ 112,10	98

CODE INDEX

CODE	DIGIT	UNIT PRICE	PAGE	CODE	DIGIT	UNIT PRICE	PAGE	CODE	DIGIT	UNIT PRICE	PAGE
SECC00035	IP09	€ 112,10	98	SECC00055	0618	€ 13,90	178	SECC00057	0618	€ 13,90	110
SECC00035	IP04	€ 112,10	98	SECC00055	0615	€ 13,90	179	SECC00057	0618	€ 13,90	111
SECC00037	IP15	€ 104,40	98	SECC00055	0618	€ 13,90	179	SECC00057	0618	€ 13,90	112
SECC00037	IP02	€ 104,40	98	SECC00055	0609	€ 13,90	179	SECC00057	0618	€ 13,90	113
SECC00037	IP09	€ 104,40	98	SECC00055	0620	€ 13,90	179	SECC00057	0599	€ 9,95	133
SECC00037	IP04	€ 104,40	98	SECC00055	0615	€ 13,90	184	SECC00057	0299	€ 9,95	133
SECC00040	IP15	€ 114,00	98	SECC00055	0602	€ 13,90	184	SECC00061	0015	€ 47,40	97
SECC00040	IP02	€ 114,00	98	SECC00055	0620	€ 13,90	184	SECC00061	0002	€ 47,40	97
SECC00040	IP09	€ 114,00	98	SECC00055	0609	€ 13,90	184	SECC00061	0009	€ 47,40	97
SECC00040	IP04	€ 114,00	98	SECC00055	0618	€ 13,90	184	SECC00061	0004	€ 47,40	97
SECC00042	IP99	€ 76,90	118	SECC00055	0615	€ 13,90	189	SECC00061	0015	€ 47,40	97
SECC00044	0015	€ 78,70	99	SECC00055	0602	€ 13,90	189	SECC00061	0002	€ 47,40	97
SECC00044	0002	€ 78,70	99	SECC00055	0609	€ 13,90	189	SECC00061	0009	€ 47,40	97
SECC00044	0009	€ 78,70	99	SECC00055	0620	€ 13,90	189	SECC00061	0004	€ 47,40	97
SECC00044	0004	€ 78,70	99	SECC00055	0618	€ 13,90	189	SECC00065	0618	€ 27,40	111
SECC00044	0099	€ 76,60	118	SECC00056	0599	€ 4,50	134	SECC00065	0618	€ 27,40	114
SECC00046	0015	€ 99,10	99	SECC00056	0299	€ 4,50	134	SECC00065	0099	€ 20,70	132
SECC00046	0002	€ 99,10	99	SECC00056	0617	€ 6,60	134	SECC00065	0015	€ 27,40	184
SECC00046	0009	€ 99,10	99	SECC00056	0604	€ 6,60	134	SECC00065	0002	€ 27,40	184
SECC00046	0004	€ 99,10	99	SECC00056	0599	€ 4,50	141	SECC00065	0009	€ 27,40	184
SECC00054	0615	€ 7,25	174	SECC00056	0299	€ 4,50	141	SECC00065	0004	€ 27,40	184
SECC00054	0618	€ 7,25	174	SECC00056	0999	€ 4,50	141	SECC00065	0015	€ 27,40	189
SECC00054	0615	€ 7,25	184	SECC00056	0499	€ 4,50	141	SECC00065	0002	€ 27,40	189
SECC00054	0602	€ 7,25	184	SECC00056	0508	€ 6,60	163	SECC00065	0009	€ 27,40	189
SECC00054	0603	€ 7,25	184	SECC00056	0208	€ 6,60	163	SECC00065	0004	€ 27,40	189
SECC00054	0604	€ 7,25	184	SECC00056	0908	€ 6,60	163	SECC00068	0099	€ 19,50	132
SECC00054	0618	€ 7,25	184	SECC00056	0408	€ 6,60	163	SECC00142	IP15	€ 95,00	98
SECC00054	0615	€ 7,25	189	SECC00056	0615	€ 6,60	166	SECC00142	IP02	€ 95,00	98
SECC00054	0602	€ 7,25	189	SECC00056	0618	€ 6,60	166	SECC00142	IP09	€ 95,00	98
SECC00054	0617	€ 7,25	189	SECC00056	0615	€ 6,60	168	SECC00142	IP04	€ 95,00	98
SECC00054	0604	€ 7,25	189	SECC00056	0618	€ 6,60	168	SECC70002		€ 6,80	164
SECC00054	0618	€ 7,25	189	SECC00056	0615	€ 6,60	170	SECC70002		€ 6,80	175
SECC00055	0620	€ 13,90	107	SECC00056	0618	€ 6,60	170	SECC70002		€ 6,80	176
SECC00055	0618	€ 13,90	107	SECC00056	0615	€ 6,60	171	SECC70003		€ 6,80	164
SECC00055	0618	€ 13,90	108	SECC00056	0618	€ 6,60	171	SECC70003		€ 6,80	175
SECC00055	0618	€ 13,90	109	SECC00056	0615	€ 6,60	172	SECC70003		€ 6,80	176
SECC00055	0620	€ 13,90	110	SECC00056	0618	€ 6,60	172	SECC70027	NNNB	€ 13,20	142
SECC00055	0618	€ 13,90	110	SECC00056	0615	€ 6,60	173	SECC70027	NNNR	€ 13,20	142
SECC00055	0618	€ 13,90	111	SECC00056	0618	€ 6,60	173	SECC70027	NNB6	€ 13,20	164
SECC00055	0618	€ 13,90	112	SECC00056	0615	€ 6,60	175	SECC70027	NNR6	€ 13,20	164
SECC00055	0618	€ 13,90	113	SECC00056	0618	€ 6,60	175	SECC70027	NNB6	€ 13,20	175
SECC00055	0599	€ 9,95	133	SECC00056	0617	€ 6,60	175	SECC70027	NNR6	€ 13,20	175
SECC00055	0299	€ 9,95	133	SECC00056	0604	€ 6,60	175	SECC70027	NNB6	€ 13,20	176
SECC00055	0599	€ 9,95	134	SECC00056	0615	€ 6,60	177	SECC70027	NNR6	€ 13,20	176
SECC00055	0299	€ 9,95	134	SECC00056	0618	€ 6,60	177	SECC70043		€ 6,80	142
SECC00055	0599	€ 9,95	141	SECC00056	0617	€ 6,60	177	SPUG00001	0013	€ 2,85	65
SECC00055	0299	€ 9,95	141	SECC00056	0604	€ 6,60	177	SPUG00001	0003	€ 2,85	65
SECC00055	0605	€ 13,90	163	SECC00056	0615	€ 6,60	178	SPUG00001	0029	€ 2,85	65
SECC00055	0602	€ 13,90	163	SECC00056	0618	€ 6,60	178	SPUG00002		€ 5,00	27
SECC00055	0609	€ 13,90	163	SECC00056	0615	€ 6,60	179	SPUG00003		€ 5,60	27
SECC00055	0620	€ 13,90	163	SECC00056	0618	€ 6,60	179	SPUG00004		€ 6,00	32
SECC00055	0615	€ 13,90	167	SECC00056	0617	€ 6,60	179	SPUG00005		€ 8,15	32
SECC00055	0618	€ 13,90	167	SECC00056	0604	€ 6,60	179	SPUG00010		€ 0,72	81
SECC00055	0615	€ 13,90	168	SECC00056	0615	€ 6,60	184	SPUG00013		€ 6,00	33
SECC00055	0618	€ 13,90	168	SECC00056	0602	€ 6,60	184	SPUG00016	0005	€ 0,82	81
SECC00055	0615	€ 13,90	170	SECC00056	0617	€ 6,60	184	SPUG00016	0002	€ 0,82	81
SECC00055	0618	€ 13,90	170	SECC00056	0604	€ 6,60	184	SPUG00016	0003	€ 0,82	81
SECC00055	0615	€ 13,90	171	SECC00056	0615	€ 6,60	189	SPUG00016	0004	€ 0,82	81
SECC00055	0618	€ 13,90	171	SECC00056	0602	€ 6,60	189	SPUG00017	0005	€ 0,72	81
SECC00055	0615	€ 13,90	172	SECC00056	0617	€ 6,60	189	SPUG00017	0011	€ 0,72	81
SECC00055	0618	€ 13,90	172	SECC00056	0604	€ 6,60	189	SPUG00017	0004	€ 0,72	81
SECC00055	0615	€ 13,90	174	SECC00057	0620	€ 13,90	107	SPUG00022	0001	€ 2,85	65
SECC00055	0618	€ 13,90	174	SECC00057	0618	€ 13,90	107	SPUG70004		€ 1,83	230
SECC00055	0615	€ 13,90	177	SECC00057	0618	€ 13,90	108	STR100002	0015	€ 2,45	60
SECC00055	0618	€ 13,90	177	SECC00057	0618	€ 13,90	109	STR100002	0002	€ 2,45	60
SECC00055	0615	€ 13,90	178	SECC00057	0620	€ 13,90	110	STR100002	0009	€ 2,45	60

CODE INDEX

CODE	DIGIT	UNIT PRICE	PAGE	CODE	DIGIT	UNIT PRICE	PAGE	CODE	DIGIT	UNIT PRICE	PAGE
STRI00002	0004	€ 2,45	60	STRI00030	IP04	€ 54,90	108	STRI00030	IP15	€ 54,90	172
STRI00002	0015	€ 2,45	60	STRI00030	IP15	€ 54,90	108	STRI00030	IP15	€ 54,90	174
STRI00002	0002	€ 2,45	60	STRI00030	IP02	€ 54,90	108	STRI00030	IP15	€ 54,90	177
STRI00002	0009	€ 2,45	60	STRI00030	IP09	€ 54,90	108	STRI00030	IP15	€ 54,90	178
STRI00002	0004	€ 2,45	60	STRI00030	IP04	€ 54,90	108	STRI00030	IP15	€ 54,90	179
STRI00002	0099	€ 2,05	60	STRI00030	IP15	€ 54,90	109	STRI00030	IP15	€ 54,90	194
STRI00003	0015	€ 49,50	97	STRI00030	IP02	€ 54,90	109	STRI00030	IP02	€ 54,90	194
STRI00003	0002	€ 49,50	97	STRI00030	IP09	€ 54,90	109	STRI00030	IP09	€ 54,90	194
STRI00003	0009	€ 49,50	97	STRI00030	IP04	€ 54,90	109	STRI00030	IP04	€ 54,90	194
STRI00003	0004	€ 49,50	97	STRI00030	IP15	€ 54,90	109	STRI00035	IPGX	€ 54,90	132
STRI00003	0099	€ 49,50	141	STRI00030	IP02	€ 54,90	109	STRI00065	0006	€ 2,75	212
STRI00003	0015	€ 49,50	163	STRI00030	IP09	€ 54,90	109	STRI00072	IP09	€ 70,00	107
STRI00003	0002	€ 49,50	163	STRI00030	IP04	€ 54,90	109	STRI00072	IP09	€ 70,00	107
STRI00003	0009	€ 49,50	163	STRI00030	IP15	€ 54,90	110	STRI00072	IP09	€ 70,00	108
STRI00003	0004	€ 49,50	163	STRI00030	IP02	€ 54,90	110	STRI00072	IP09	€ 70,00	108
STRI00003	0015	€ 49,50	194	STRI00030	IP09	€ 54,90	110	STRI00072	IP09	€ 70,00	109
STRI00003	0002	€ 49,50	194	STRI00030	IP04	€ 54,90	110	STRI00072	IP09	€ 70,00	109
STRI00003	0009	€ 49,50	194	STRI00030	IP15	€ 54,90	110	STRI00072	IP09	€ 70,00	110
STRI00003	0004	€ 49,50	194	STRI00030	IP02	€ 54,90	110	STRI00072	IP09	€ 70,00	110
STRI00007	0099	€ 98,90	141	STRI00030	IP09	€ 54,90	110	STRI00072	IP09	€ 70,00	111
STRI00007	0015	€ 98,90	163	STRI00030	IP04	€ 54,90	110	STRI00072	IP09	€ 70,00	111
STRI00007	0002	€ 98,90	163	STRI00030	IP15	€ 54,90	111	STRI00072	IP09	€ 70,00	111
STRI00007	0009	€ 98,90	163	STRI00030	IP02	€ 54,90	111	STRI00072	IP09	€ 70,00	112
STRI00007	0004	€ 98,90	163	STRI00030	IP09	€ 54,90	111	STRI00072	IP09	€ 70,00	113
STRI00007	IP15	€ 98,90	167	STRI00030	IP04	€ 54,90	111	STRI00072	IP09	€ 70,00	113
STRI00007	IP15	€ 98,90	168	STRI00030	IP15	€ 54,90	111	STRI00072	IP09	€ 70,00	114
STRI00007	IP15	€ 98,90	170	STRI00030	IP02	€ 54,90	111	STRI00072	IP13	€ 70,00	141
STRI00007	0015	€ 98,90	194	STRI00030	IP09	€ 54,90	111	STRI00072	IP09	€ 70,00	163
STRI00007	0002	€ 98,90	194	STRI00030	IP04	€ 54,90	111	STRI00072	IP09	€ 70,00	167
STRI00007	0009	€ 98,90	194	STRI00030	IP15	€ 54,90	111	STRI00072	IP09	€ 70,00	174
STRI00007	0004	€ 98,90	194	STRI00030	IP02	€ 54,90	111	STRI00072	IP09	€ 70,00	177
STRI00030	IP15	€ 54,90	97	STRI00030	IP09	€ 54,90	111	STRI00072	IP09	€ 70,00	178
STRI00030	IP02	€ 54,90	97	STRI00030	IP04	€ 54,90	111	STRI00072	IP09	€ 70,00	193
STRI00030	IP09	€ 54,90	97	STRI00030	IP15	€ 54,90	112	STRI00072	IP13	€ 70,00	193
STRI00030	IP04	€ 54,90	97	STRI00030	IP02	€ 54,90	112	STRI00073	IP09	€ 60,00	193
STRI00030	IP15	€ 54,90	97	STRI00030	IP09	€ 54,90	112	STRI00073	IP13	€ 60,00	193
STRI00030	IP02	€ 54,90	97	STRI00030	IP04	€ 54,90	112	STRI70002	S ST	€ 12,70	237
STRI00030	IP09	€ 54,90	97	STRI00030	IP15	€ 54,90	112	STRI70031		€ 8,95	237
STRI00030	IP04	€ 54,90	97	STRI00030	IP02	€ 54,90	112	SUPP00001		€ 9,60	232
STRI00030	IP15	€ 54,90	98	STRI00030	IP09	€ 54,90	112	SUPP00002		€ 10,70	232
STRI00030	IP02	€ 54,90	98	STRI00030	IP04	€ 54,90	112	SUPP00003		€ 12,20	232
STRI00030	IP09	€ 54,90	98	STRI00030	IP15	€ 54,90	113	SUPP00004		€ 13,10	232
STRI00030	IP04	€ 54,90	98	STRI00030	IP02	€ 54,90	113	SUPP00005		€ 13,60	232
STRI00030	IP15	€ 54,90	98	STRI00030	IP09	€ 54,90	113	SUPP00006		€ 14,30	232
STRI00030	IP02	€ 54,90	98	STRI00030	IP04	€ 54,90	113	SUPP00007		€ 15,80	232
STRI00030	IP09	€ 54,90	98	STRI00030	IP15	€ 54,90	113	SUPP00008		€ 3,60	233
STRI00030	IP04	€ 54,90	98	STRI00030	IP02	€ 54,90	113	SUPP00009		€ 4,00	233
STRI00030	IP15	€ 54,90	98	STRI00030	IP09	€ 54,90	113	SUPP00010		€ 4,30	233
STRI00030	IP02	€ 54,90	98	STRI00030	IP04	€ 54,90	113	SUPP00011		€ 4,90	233
STRI00030	IP09	€ 54,90	98	STRI00030	IP15	€ 54,90	114	SUPP00012		€ 5,20	233
STRI00030	IP04	€ 54,90	98	STRI00030	IP02	€ 54,90	114	SUPP00013		€ 5,60	233
STRI00030	IP15	€ 54,90	98	STRI00030	IP09	€ 54,90	114	SUPP00014		€ 6,10	233
STRI00030	IP02	€ 54,90	98	STRI00030	IP04	€ 54,90	114	SUPP70143	2 M25ST	€ 1,93	234
STRI00030	IP09	€ 54,90	98	STRI00030	IP15	€ 54,90	132	SUPP70144	2 M25ST	€ 2,24	234
STRI00030	IP04	€ 54,90	98	STRI00030	IPGX	€ 54,90	132	SUPP70145	2 M25ST	€ 2,64	234
STRI00030	IP15	€ 54,90	107	STRI00030	IPGX	€ 54,90	133	SUPP70146	2 M25ST	€ 2,95	234
STRI00030	IP02	€ 54,90	107	STRI00030	IPGX	€ 54,90	134	SUPP70147	2 M25ST	€ 3,25	234
STRI00030	IP09	€ 54,90	107	STRI00030	IPGX	€ 54,90	141	SUPP70148	2 M25ST	€ 3,55	234
STRI00030	IP04	€ 54,90	107	STRI00030	IP15	€ 54,90	163	SUPP70165	3 M25ST	€ 4,98	233
STRI00030	IP15	€ 54,90	107	STRI00030	IP02	€ 54,90	163	SUPP70166	3 M25ST	€ 5,60	233
STRI00030	IP02	€ 54,90	107	STRI00030	IP09	€ 54,90	163	SUPP70167	3 M25ST	€ 6,20	233
STRI00030	IP09	€ 54,90	107	STRI00030	IP04	€ 54,90	163	SUPP70168	3 M25ST	€ 6,80	233
STRI00030	IP04	€ 54,90	107	STRI00030	IP15	€ 54,90	167	SUPP70169	3 M25ST	€ 7,31	233
STRI00030	IP15	€ 54,90	108	STRI00030	IP15	€ 54,90	168	SUPP70170	3 M25ST	€ 8,12	233
STRI00030	IP02	€ 54,90	108	STRI00030	IP15	€ 54,90	170	SUPP70171	3 M25ST	€ 8,53	233
STRI00030	IP09	€ 54,90	108	STRI00030	IP15	€ 54,90	171	SUPP80158		€ 3,75	228

CODE INDEX

CODE	DIGIT	UNIT PRICE	PAGE	CODE	DIGIT	UNIT PRICE	PAGE	CODE	DIGIT	UNIT PRICE	PAGE
SUPP80160		€ 4,55	228	TERI70023	XX4GG-G5SS2111ST	€ 262,00	215	VECO00006		€ 12,10	235
SUPP80161		€ 5,40	228	TERI70023	XX4GG-G5SS8111ST	€ 293,70	219	VECO00007		€ 14,35	235
SUPP80303		€ 3,05	228	TERI70029	GG4GZ-Z5SS2111ST	€ 120,60	215	VECO00008		€ 7,55	235
SUPP80305		€ 4,20	228	TERI70029	GG4GZ-Z5SS8111ST	€ 152,50	219	VECO00009		€ 9,45	235
SUPP80307		€ 5,00	228	TERI70031	GG4GZ-Z5SS2111ST	€ 122,30	215	VECO00010		€ 10,60	235
TBBP00516		€ 18,20	185	TERI70031	GG4GZ-Z5SS8111ST	€ 156,60	219	VECO00012	0003	€ 4,70	235
TBBP00516		€ 18,20	191	TERI70033	GG4GZ-Z5SS2111ST	€ 113,80	215	VECO00013	0003	€ 5,20	235
TERG00001		€ 19,70	232	TERI70033	GG4GZ-Z5SS8111ST	€ 145,60	218	VECO00014	0003	€ 5,80	235
TERG00002		€ 20,80	232	TERI70034	0000E18G32121ST	€ 22,35	215	VECO00016	0003	€ 3,35	235
TERG00003		€ 21,90	232	TERI70034	0000E18G38121ST	€ 52,80	217	VECO00017	0003	€ 3,80	235
TERG00004		€ 22,60	232	TERI70036	IZ4GZZ4G22112ST	€ 65,50	215	VECO00018	0003	€ 4,10	235
TERG00005		€ 23,90	232	TERI70036	IZ4GZZ4G28112ST	€ 97,30	218	VECO00019		€ 8,65	235
TERG00006		€ 24,40	232	TERI70042	GG4GG-G5SS2111ST	€ 139,20	215	VECO00020		€ 10,70	235
TERG00007		€ 25,70	232	TERI70042	GG4GG-G5SS8111ST	€ 182,80	219	VECO00021		€ 12,50	235
TERG00008		€ 9,35	233	TERI70043	XX4GG-G5SS2111ST	€ 151,50	215	VECO70159	NOK 05ST	€ 2,45	235
TERG00009		€ 9,75	233	TERI70043	XX4GG-G5SS8111ST	€ 195,30	219	VECO70160	NOK 05ST	€ 2,75	235
TERG00010		€ 10,20	233	TERI70044	XX4GG-G5SS2111ST	€ 179,10	215	VECO80235		€ 7,10	230
TERG00011		€ 10,70	233	TERI70044	XX4GG-G5SS8111ST	€ 222,70	219	VECO80236		€ 7,30	230
TERG00012		€ 11,00	233	TERI70045	XX4GG-G5SS2111ST	€ 265,10	215	VECO80237		€ 7,55	230
TERG00013		€ 11,50	233	TERI70045	XX4GG-G5SS8111ST	€ 309,00	219	VECO80242		€ 13,30	230
TERG00014		€ 12,00	233	TERI70046	GG4GZ-Z5SS2111ST	€ 123,90	215	VECO80243		€ 14,50	230
TERG00035	IP09	€ 10,60	234	TERI70046	GG4GZ-Z5SS8111ST	€ 160,20	219	VECO80244		€ 15,70	230
TERG70023	ST62 S23ST	€ 3,65	234	TERI70047	GG4GZ-Z5SS2111ST	€ 115,40	215	VELL00001		€ 4,30	236
TERG70024	ST62 S23ST	€ 3,97	234	TERI70047	GG4GZ-Z5SS8111ST	€ 153,30	218	VELL00002		€ 5,70	236
TERG70025	ST62 S23ST	€ 4,27	234	TERI70048	GG4GZ-Z5SS2111ST	€ 117,10	215	VELL00003		€ 6,50	236
TERG70026	ST62 S23ST	€ 4,47	234	TERI70048	GG4GZ-Z5SS8111ST	€ 160,70	218	VELL00004		€ 6,80	236
TERG70027	ST62 S23ST	€ 4,77	234	TESS00012		€ 3,15	22	VELL00005		€ 5,10	236
TERG70028	ST62 S23ST	€ 5,08	234	TESS00276		€ 4,30	65	VELL00006		€ 6,70	236
TERG70044	NOX3 S30ST	€ 11,70	233	TESS00276		€ 4,30	216	VELL00007		€ 8,25	236
TERG70045	NOX3 S30ST	€ 12,20	233	TESS00290		€ 4,50	65	VELL00008		€ 5,30	236
TERG70046	NOX3 S30ST	€ 12,80	233	TESS00290		€ 4,50	216	VELL00009		€ 6,90	236
TERG70047	NOX3 S30ST	€ 13,60	233	TESS00316		€ 4,70	65	VELL00010		€ 8,55	236
TERG70048	NOX3 S30ST	€ 14,11	233	TESS00316		€ 4,70	216	VELL00014		€ 5,10	236
TERG70049	NOX3 S30ST	€ 14,72	233	TESS00374	0005	€ 30,05	225	VELL00016		€ 5,80	236
TERG70050	NOX3 S30ST	€ 15,13	233	TESS00374	0005	€ 26,60	225	VELL00017		€ 6,50	236
TERG80154		€ 12,40	230	TESS00376	0002	€ 23,35	225	VELL00018		€ 7,00	236
TERG80156		€ 13,20	230	TESS00377	0002	€ 27,70	225	VELL00019		€ 6,00	236
TERG80158		€ 14,00	230	TESS00379		€ 19,00	225	VELL00020		€ 7,35	236
TERG80200	IPIA	€ 48,00	228	TESS00379		€ 19,00	225	VELL00021		€ 8,15	236
TERG80201	IPIA	€ 51,60	228	TESS00380		€ 27,70	225	VELL00033		€ 5,20	236
TERG80202	IPIA	€ 55,20	228	TEVE00001	IP09	€ 17,90	237	VELL00034		€ 6,00	236
TERI70012	XX4GG-G5SS2111ST	€ 149,90	215	TEVE70076	N08IE111EU21ST	€ 19,90	237	VELL00035		€ 6,70	236
TERI70012	XX4GG-G5SS8111ST	€ 187,80	219	TEVE70077	N08IE111EU21ST	€ 22,05	237	VELL00036		€ 8,12	236
TERI70013	XX4GG-G5SS2111ST	€ 177,40	215	TEVE70078	N08IE111EU21ST	€ 24,50	237	VELL70107	NO 7 08ST	€ 5,40	236
TERI70013	XX4GG-G5SS8111ST	€ 215,40	219	VECO00001		€ 8,95	235	VELL70108	NO 7 08ST	€ 6,30	236
TERI70017	GG4GG-G5SS2111ST	€ 137,50	215	VECO000015	0003	€ 7,55	235	VELL70109	NO 7 08ST	€ 7,31	236
TERI70017	GG4GG-G5SS8111ST	€ 175,40	219	VECO00002		€ 10,90	235	VELL80228		€ 14,40	228
TERI70018	XX4GG-G5SS2111ST	€ 263,50	215	VECO00003		€ 12,30	235	VELL80229		€ 16,80	228
TERI70018	XX4GG-G5SS8111ST	€ 301,40	219	VECO00004		€ 14,45	235	VELL80230		€ 19,20	228
TERI70020	GG4GG-G5SS2111ST	€ 135,80	215	VECO00005		€ 9,95	235				
TERI70020	GG4GG-G5SS8111ST	€ 167,70	219								
TERI70021	XX4GG-G5SS2111ST	€ 148,30	215								
TERI70021	XX4GG-G5SS8111ST	€ 180,10	219								
TERI70022	XX4GG-G5SS2111ST	€ 175,80	215								
TERI70022	XX4GG-G5SS8111ST	€ 207,60	219								

SALES TERMS AND CONDITIONS



Purchase orders placed to IPC TOOLS S.p.A. are submitted to the ongoing sales terms and conditions, except otherwise agreed between the Parties in each specified contract.

1. IPC TOOLS PRODUCTS:

- a. All products manufactured by IPC TOOLS S.p.A. conform to safety and quality standards and are suitable for their proper use.
- b. Technical specifications, descriptions and pictures related to various products listed herein are purely indicative and IPC TOOLS S.p.A. reserves the right to amend such information in the case any change is considered necessary.
- c. Volumes and weights provided herein refer to standard single package quantities.

2. PRICES

- a. All prices herein do not include VAT and delivery terms are EX Works Villa del Conte (INCOTERMS 2000).
- b. The prices herein are valid unless otherwise specified.

3. PURCHASE ORDERS

- a. All purchase orders are "subject to approval by seller".
- b. Minimum amount per order accepted is € 500,00, VAT not included.
- c. All quantities in the purchase orders shall refer the standard single packing.
- d. Each purchase order shall include product code and description.

4. PACKAGING

- a. Packaging is included in the list prices.
- b. For mop wringers packed separately from the trolley, an extra-charge of € 1,200 will be added.

5. PAYMENT:

- a. The Client undertakes to pay for the goods in accordance with the terms agreed with IPC TOOLS S.p.A. and indicated in the invoice.
- b. In case of expired and delayed payments the interest shall be calculated at the current rate.

6. TRANSPORT

- a. Transport duties are at Client's expense, unless otherwise agreed between the Parties.

7. DELIVERY TIMES

- a. Delivery times are not compulsory.
- b. A delay in delivery shall not be cause of any delay in payment or request for damages.

8. NON-COLLECTION OF GOODS

- a. Non-collection of the goods of Client's purchase orders within a period of thirty days from the date agreed, shall allow the seller to cancel the contract "ipso iure" and any payment received in advance shall be withheld by the seller, as penalty, except the case of an heavier loss.

9. SALES RETURNS

- a. All returns are subject to prior approval by IPC TOOLS S.p.A.
- b. Once the returns are authorised, they shall be returned free of damage and in the original packaging.
- c. All transport costs to return the goods are at the Client's expense.

10. INPROPER USE OF PRODUCTS

- a. IPC TOOLS S.p.A. shall not be liable for any damage caused by or to the products due to improper or incorrect use of the products, non-compliance with the provided instructions, lack or inaccurate maintenance, tampering or alteration of the products.

11. CLAIMS

- a. Once the goods have been delivered at his premises, the Client shall check and inspect them: any remarks or comments related to damages or missing items shall be made at the moment of delivery to the carrier and mentioned on the delivery note.
- b. Any product defects shall be notified in writing to the seller (sent by fax or e-mail) within the times described by the law in force.
- c. Claims received verbally or on the phone shall not be considered as valid.
- d. No product may be returned without prior authorisation by IPC TOOLS S.p.A. (refer to clause Sales Returns)

12. APPLICABLE LAW AND COMPETENT COURT

- a. Any dispute or controversy arising from this contract or transactions hereunder shall be submitted to the sole jurisdiction of the Court of Padua, Italy.

13. PRICE LIST

- a. The price list hereby cancels all previous price lists.

14. ACCEPTANCE OF SALES TERMS AND CONDITIONS

- a. The Client expressly agrees to all the sales terms and conditions herein once he places a purchase order.

IPC Tools S.p.a.
Via dell'Artigianato II, 1 - 35010 Villa del Conte (Padova) - Italy
Via 11 settembre, 4 - Ronchi - 35010 Villafranca Padovana (Padova) - Italy

info@ipcworldwide.com - www.ipcworldwide.com

